

STANDARD HORIZON

Nothing takes to water like Standard Horizon

ECLIPSE DSC+ GX1150

25 Watt VHF/FM

Class D DSC Marine Transceiver

Owner's Manual

- Replaces older Eclipse+ and Eclipse DSC Models
- Meets ITU-R M493-12 regulation
- 16/9, H/L and channel keys on the mic
- DSC test call
- Auto DSC channel change selection
- Full dot matrix display
- Submersible JIS-7 / IPX7 (3.3 feet for 30 minutes)
- NMEA 0183 Input and Output
- Time and GPS position information shown on display*
- Programmable Scan, Priority Scan, and Dual Watch
- NOAA Weather Channels with Alert
- All USA/International and Canadian Marine Channels
- 3 Year Waterproof Warranty

※ When GPS connected



TABLE OF CONTENTS

QUICK REFERENCE GUIDE	4
1 GENERAL INFORMATION	6
2 ON-LINE WARRANTY REGISTRATION (in USA or Canada only)	6
3 PACKING LIST	7
4 OPTIONS	7
5 SAFETY / WARNING INFORMATION	7
6 FCC RADIO LICENSE INFORMATION	8
7 FCC NOTICE	9
8 GETTING STARTED	10
8.1 ABOUT VHF RADIO	10
8.2 SELECTING AN ANTENNA	10
8.3 COAXIAL CABLE	11
8.4 EMERGENCY (CHANNEL 16 USE)	12
8.5 CALLING ANOTHER VESSEL (CHANNEL 16 OR 9)	12
8.6 MAKING TELEPHONE CALLS	13
8.7 OPERATING ON CHANNELS 13 AND 67	13
9 INSTALLATION	14
9.1 LOCATION	14
9.2 MOUNTING THE RADIO	14
9.2.1 Supplied Mounting Bracket	14
9.2.2 Optional MMB-84 Flush Mount Bracket	15
9.3 ELECTRICAL CONNECTIONS	16
9.4 ACCESSORY CABLE	17
9.5 CHECKING GPS CONNECTIONS	17
9.6 CHANGING THE GPS TIME	18
9.7 CHANGING THE TIME LOCATION	19
10 CONTROLS AND INDICATORS	20
11 BASIC OPERATION	24
11.1 RECEPTION	24
11.2 TRANSMISSION	24
11.3 TRANSMIT TIME-OUT TIMER (TOT)	24
11.4 SIMPLEX / DUPLEX CHANNEL USE	25
11.5 INTERNATIONAL, USA, AND CANADA MODE	25
11.6 NOAA WEATHER CHANNELS	25
11.6.1 NOAA Weather Alert	25
11.6.2 NOAA Weather Alert Test	26
11.7 SCANNING	26
11.7.1 Selecting the Scan Type	26
11.7.2 Memory Scanning (M-SCAN)	27
11.7.3 Priority Scanning (P-SCAN)	28
11.7.4 Priority Channel Setting	28
11.7.5 Dual Watch	29

TABLE OF CONTENTS

12	DIGITAL SELECTIVE CALLING	30
12.1	GENERAL	30
12.2	MARITIME MOBILE SERVICE IDENTITY (MMSI)	30
	12.2.1 What is an MMSI?	30
	12.2.2 Programming the MMSI	31
12.3	DISTRESS ALERT	32
	12.3.1 Transmitting a Distress Alert	32
	12.3.2 Receiving a Distress Alert	34
12.4	ALL SHIPS CALL	35
	12.4.1 Transmitting an All Ships Call	35
	12.4.2 Receiving an All Ships Call	36
12.5	INDIVIDUAL CALL	37
	12.5.1 Setting up the Individual / Position Call Directory	37
	12.5.2 Setting up Individual Reply	38
	12.5.3 Setting Up the Individual Acknowledge Message	39
	12.5.4 Setting up Individual Call Ringer	40
	12.5.5 Transmitting an Individual Call	41
	12.5.6 Receiving an Individual Call	43
12.6	CALL WAITING DIRECTORY	44
	12.6.1 Enabling / Disabling the Call Waiting Feature	44
	12.6.2 Reviewing Received Calls Logged into the Call Waiting Directory	44
	12.6.3 Deleting DSC Log Calls	45
12.7	GROUP CALL	46
	12.7.1 Setting up a Group Call	46
	12.7.2 Transmitting a Group Call	47
	12.7.3 Receiving a Group Call	49
	12.7.4 Setting up Group Call Ringer	50
12.8	POSITION REQUEST	51
	12.8.1 Setting up the Position Reply	51
	12.8.2 Transmitting a Position Request to Another Vessel	52
	12.8.3 Receiving a Position Request	54
12.9	POSITION REPORT	55
	12.9.1 Setting up Position Report Ringer	55
	12.9.2 Transmitting a DSC Position Report Call	56
	12.9.3 Receiving a DSC Position Report Call	57
12.10	DSC TRANSMISSION TEST	58
12.11	MANUAL INPUTTING OF THE GPS LOCATION (LAT/LON)	59
13	RADIO SETUP	60
13.1	LAMP ADJUSTING	60
13.2	LCD CONTRAST	60
13.3	TIME OFFSET	61
13.4	TIME DISPLAY	62
13.5	PRIORITY CHANNEL SET	62
13.6	SCAN TYPE	63
13.7	KEY BEEP (ON/OFF)	63
13.8	WX ALERT	64
14	MAINTENANCE	65
14.1	REPLACEMENT PARTS	65
14.2	FACTORY SERVICE	66
14.3	TROUBLESHOOTING CHART	66
15	CHANNEL ASSIGNMENTS	67
16	WARRANTY	73
17	SPECIFICATIONS	76

QUICK REFERENCE GUIDE I

CHANNEL SELECT BUTTONS

Selects the operating channel.

POWER SWITCH / VOL KNOB

Turn the transceiver on and off, and adjust the audio level.

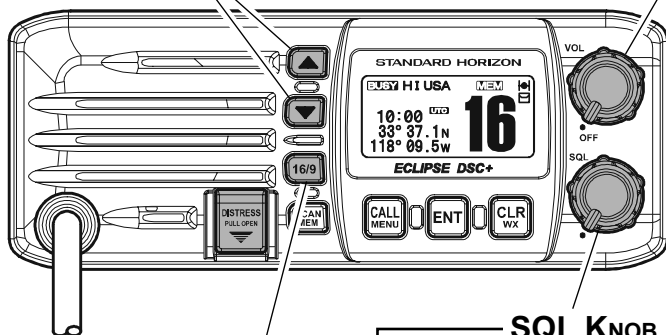

16/9 BUTTON

- Press to recall channel 16.
- Press and hold to recall channel 9.
- Press again to revert to the last selected channel.

SQL KNOB

Move this control clockwise to squelch or counter clockwise un-squelch the radio.

TRANSMISSION SWITCH

Speak into the microphone in a normal voice level while pressing this switch.

CHANNEL SELECT BUTTONS

Selects the operating channel.

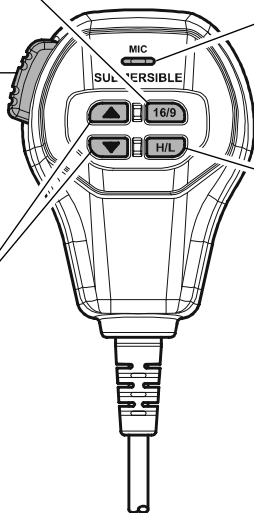

MIC HOLE

Be sure your mouth is about 1/2 inch (1.3 cm) from the mic hole for best performance.

H/L BUTTON

When pressed, toggles the transmit power between High (25W) and Low (1W).

QUICK REFERENCE GUIDE II

CHANNEL SELECT BUTTONS

- Press to select a VHF or WX channel.
- Used to select a desired channel and to select items in the DSC OPERATION and SETUP menus.

CLR / WX BUTTON

- Press to cancel the menu selection.
- Press and hold to recall the last-used NOAA Weather Channel.

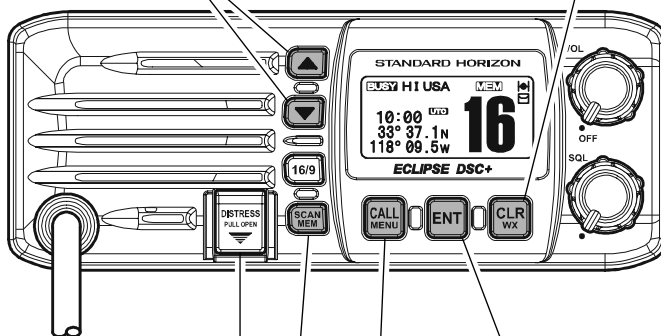

DISTRESS BUTTON

Note: for this key to operate a MMSI must be programmed. Lift the red cover, press the Distress button once, then press and hold until the radio alarms.

ENT BUTTON

When Radio or DSC menus are selected, pressing this key saves a selection.

SCAN / MEM BUTTON

- Press and hold to save or remove a channel from scan memory.
- Press to start and stop the scanning of programmed channels.



CALL / MENU BUTTON

- Press to access the "DSC MENU".
- Press and hold to access the Radio and DSC setup menus.

1 GENERAL INFORMATION

The **GX1150 ECLIPSE DSC+** is a VHF/FM transceiver designed for use in the frequency range of 156.025 to 163.275 MHz. The **GX1150** can be operated from 11 to 16 VDC and has a switchable RF output power of 1 watt or 25 watts.

The **GX1150** is capable of DSC (Digital Selective Calling) Class D (independent Channel 70 receiver) operation which allows continuous receiving of Digital Selective Calling functions on channel 70 even if the radio is receiving a call.

The **GX1150** operates on all currently-allocated marine channels which are switchable for use with either USA, International, or Canadian regulations. It has an emergency channel 16 which can be immediately selected from any channel by pressing the red  key. NOAA Weather channels can also be accessed immediately by pressing and holding the  key.

Other features of the transceiver include: scanning, priority scanning, submersible mic, high and low voltage warning, and GPS repeatability.

2 ON-LINE WARRANTY REGISTRATION (in USA or Canada only)

Please visit www.standardhorizon.com to register the **GX1150** Marine VHF. It should be noted that visiting the Web site from time to time may be beneficial to you, as new products are released they will appear on the STANDARD HORIZON Web site.

PRODUCT SUPPORT INQUIRIES

If you have any questions or comments regarding the use of the **GX1150**, you can visit the STANDARD HORIZON Web site to send an E-Mail or contact the Product Support team at (800) 767-2450 M-F 7:00AM to 5:00PM PST.

3 PACKING LIST

When the package containing the transceiver is first opened, please check it for the following contents:

- **GX1150** Transceiver
- Mounting Bracket and hardware
- Power Cord with 6 Amp fuse and holder
- Owner's Manual
- Warranty Card

4 OPTIONS

MMB-84	Flush-Mount Bracket
MLS-310	Amplified External Speaker
MLS-300	External Loudspeaker
HC1100	Dust Cover

5 SAFETY / WARNING INFORMATION

This radio is restricted to occupational use, work related operations only where the radio operator must have the knowledge to control the exposure conditions of its passengers and bystanders by maintaining the minimum separation distance of 0.6 m (2 feet).

Failure to observe these restrictions will result in exceeding the FCC RF exposure limits.

Antenna Installation:

The antenna must be located at least 0.6 m (2 feet) away from passengers in order to comply with the FCC RF exposure requirements.

6 FCC RADIO LICENSE INFORMATION

Standard Horizon radios comply with the Federal Communication Commission (FCC) requirements that regulate the Maritime Radio Service.

STATION LICENSE

An FCC ship station license is no longer required for any vessel traveling in U.S. waters (except Hawaii) which is under 20 meters in length. However, any vessel required to carry a marine radio on an international voyage, carrying a HF single side band radiotelephone or marine satellite terminal is required to have a ship station license. FCC license forms, including applications for ship (605) and land station licenses can be downloaded via the Internet at <http://www.fcc.gov/Forms/Form605/605.html>. To obtain a form from the FCC, call (888) 225-5322.

RADIO CALL SIGN

Currently the FCC does not require recreational boaters to have a Ship Radio Station License. The USCG recommends the boats registration number and the state to be used.

CANADIAN SHIP STATION LICENSING

You may need a license when traveling in Canada. If you do need a license contact their nearest field office or regional office or write:

**Industry Canada
Radio Regulatory Branch
Attn: DOSP
300 Slater Street
Ottawa, Ontario
Canada, KIA 0C8**

FCC / INDUSTRY CANADA INFORMATION

The following data pertaining to the transceiver is necessary to fill out the license application.

Type Acceptance FCC Part 80
Output Power 1 Watt (low) and 25 Watts (high)
Emission 16K0G3E, 16K0G2B
Frequency Range 156.025 to 163.275 MHz
FCC Type Number K6630373X3D
Industry Canada Type Approval 511B-30373X3S

7 FCC NOTICE

NOTICE

Unauthorized changes or modifications to this equipment may void compliance with FCC Rules. Any change or modification must be approved in writing by STANDARD HORIZON, a division of YAESU U.S.A.

NOTICE

This equipment has been tested and found to comply with the limits for a Class B digital device, pursuant to Part 15 of the FCC Rules. These limits are designed to provide reasonable protection against harmful interference in a residential installation. This equipment generates, uses and can radiate radio frequency energy and, if not installed and used in accordance with the instructions, may cause harmful interference to radio communications. However, there is no guarantee that interference will not occur in a particular installation. If this equipment does cause harmful interference to radio or television reception, which can be determined by turning the equipment off and on, the user is encouraged to try to correct the interference by one or more of the following measures:

- Reorient or relocate the receiving antenna.
- Increase the separation between the equipment and receiver.
- Connect the equipment into an outlet on a circuit different from that to which the receiver is connected.
- Consult the dealer or an experienced radio/TV technician for help.

8 GETTING STARTED

8.1 ABOUT VHF RADIO

The radio frequencies used in the VHF marine band lie between 156 and 158 MHz with some shore stations available between 161 and 163 MHz. The marine VHF band provides communications over distances that are essentially "line of sight" (VHF signals do not travel well through objects such as buildings, hills or trees). Actual transmission range depends much more on antenna type, gain and height than on the power output of the transmitter. On a fixed mount 25W radio transmission expected distances can be greater than 15 miles.

8.2 SELECTING AN ANTENNA

Marine antennas are made to radiate signals equally in all horizontal directions, but not straight up. The objective of a marine antenna is to enhance the signal toward the horizon. The degree to which this is accomplished is called the antenna's gain. It is measured in decibels (dB) and is one of the major factors in choosing an antenna. In terms of effective radiated power (ERP), antennas are rated on the basis of how much gain they have over a theoretical antenna with zero gain. A 3 foot, 3dB gain antenna represents twice as much gain over the imaginary antenna.

Typically a 3 foot 3dB gain stainless steel whip is used on a sailboat mast. The longer 8 foot 6dB fiberglass whip is primarily used on power boats that require the additional gain.

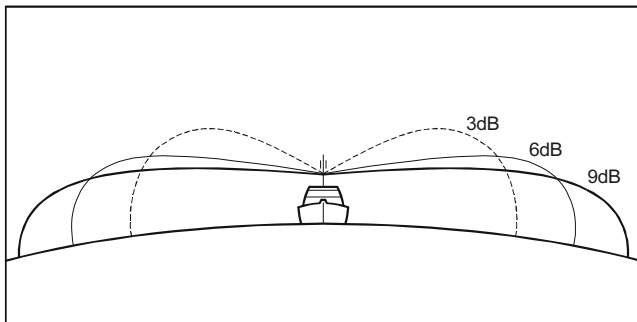

8.3 COAXIAL CABLE

VHF antennas are connected to the transceiver by means of a coaxial cable – a shielded transmission line. Coaxial cable is specified by it's diameter and construction.

For runs less than 20 feet, RG-58/U, about 1/4 inch in diameter is a good choice. For runs over 20 feet but less than 50 feet, the larger RG-8X should be used. For cable runs over 50 feet RG-213 should be used. For installation of the connector onto the coaxial cable refer to the figure below.

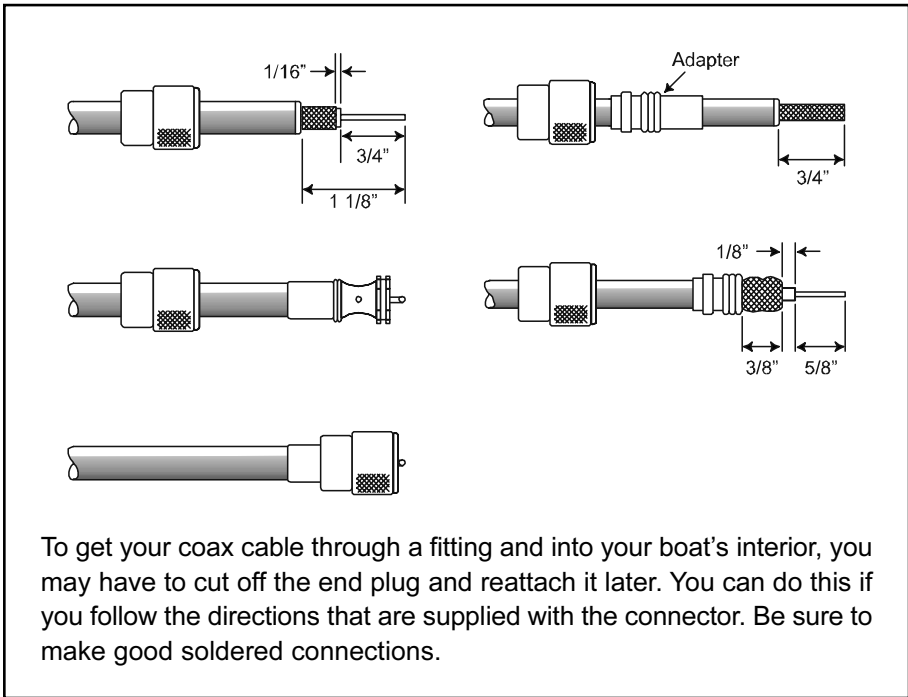

To get your coax cable through a fitting and into your boat's interior, you may have to cut off the end plug and reattach it later. You can do this if you follow the directions that are supplied with the connector. Be sure to make good soldered connections.

8.4 EMERGENCY (CHANNEL 16 USE)

Channel 16 is known as the Hail and Distress Channel. An emergency is defined as a threat to life or property. In such instances, be sure the transceiver is on and set to CHANNEL 16. Then use the following procedure:

1. Press the microphone push-to-talk switch and say “**Mayday, Mayday, Mayday**. This is _____, _____, _____” (your vessel’s name).
2. Then repeat once: “**Mayday**, _____” (your vessel’s name).
3. Now report your position in latitude/longitude, or by giving a true or magnetic bearing (state which) to a well-known landmark such as a navigation aid or geographic feature such as an island or harbour entry.
4. Explain the nature of your distress (sinking, collision, aground, fire, heart attack, life-threatening injury, etc.).
5. State the kind of assistance you desire (pumps, medical aid, etc.).
6. Report the number of persons aboard and condition of any injured.
7. Estimate the present seaworthiness and condition of your vessel.
8. Give your vessel’s description: length, design (power or sail), color and other distinguishing marks. The total transmission should not exceed 1 minute.
9. End the message by saying “**OVER**.” Release the microphone button and listen.
10. If there is no answer, repeat the above procedure. If there is still no response, try another channel.

8.5 CALLING ANOTHER VESSEL (CHANNEL 16 OR 9)

Channel 16 may be used for initial contact (hailing) with another vessel.

However, its most important use is for emergency messages. This channel must be monitored at all times except when actually using another channel.

It is monitored by the European, U.S. and Canadian Coast Guards and by other vessels. **Use of channel 16 for hailing must be limited to initial contact only.** Calling should not exceed 30 seconds, but may be repeated 3 times at 2-minute intervals. In areas of heavy radio traffic, congestion on channel 16 resulting from its use as a hailing channel can be reduced significantly in U.S. waters by using **channel 9** as the initial contact (hailing) channel for non-emergency communications. Here, also, calling time should not exceed 30 seconds but may be repeated 3 times at 2-minute intervals.

Prior to making contact with another vessel, refer to the channel charts in this manual, and select an appropriate channel for communications after initial contact. For example, Channels 68 and 69 are some of the channels available to non-commercial (recreational) boaters. Monitor your desired channel in advance to make sure you will not be interrupting other traffic, and then go back

to either channel 16 or 9 for your initial contact.

When the hailing channel (16 or 9) is clear, state the name of the other vessel you wish to call and then “**this is**” followed by the name of your vessel and your Station License (Call Sign). When the other vessel returns your call, immediately request another channel by saying “**go to,**” the number of the other channel, and “over.” Then switch to the new channel. When the new channel is not busy, call the other vessel.

After a transmission, say “**over,**” and release the microphone’s push-to-talk (PTT) switch. When all communication with the other vessel is completed, end the last transmission by stating your Call Sign and the word “**out.**” Note that it is not necessary to state your Call Sign with each transmission, only at the beginning and end of the contact.

Remember to return to Channel 16 when not using another channel. Some radios automatically monitor Channel 16 even when set to other channels or when scanning.

8.6 MAKING TELEPHONE CALLS

To make a radiotelephone call, use a channel designated for this purpose, The fastest way to learn which channels are used for radiotelephone traffic is to ask at a local marina. Channels available for such traffic are designated **Public Correspondence** channels on the channel charts in this manual. Some examples for USA use are Channels 24, 25, 26, 27, 28, 84, 85, 86, and 87. Call the marine operator and identify yourself by your vessel’s name, The marine operator will then ask you how you will pay for the call (telephone credit card, collect, etc.) and then link your radio transmission to the telephone lines.

The marine telephone company managing the VHF channel you are using may charge a link-up fee in addition to the cost of the call.

8.7 OPERATING ON CHANNELS 13 AND 67

Channel 13 is used at docks and bridges and by vessels manoeuvring in port. Messages on this channel must concern navigation only, such as meeting and passing in restricted waters.

Channel 67 is used for navigational traffic between vessels.

By regulation, power is normally limited to 1 Watt on these channels. Your radio is programmed to automatically reduce power to this limit on these channels. However, in certain situations it may be necessary to temporarily use a higher power. See page 23 ( key) for means to temporarily override the low-power limit on these two channels.

9 INSTALLATION

9.1 LOCATION

The radio can be mounted at any angle. Choose a mounting location that:

- keeps the radio and microphone at least 3.3 ft (1 m) away from your vessel's magnetic navigation compass
- provides accessibility to the front panel controls
- allows connection to a power source and an antenna
- has nearby space for installation of a microphone hanger
- the antenna must be mounted at least 3.3 ft (1 m) from radio

Note: To insure the radio does not affect the compass, or that the radios performance is not affected by the antenna location, temporarily connect the radio in the desired location and and:

- a. Examine the compass to see if the radio causes any deviation
- b. Connect the antenna and key the radio. Check to ensure the radio is operating correctly by requesting a radio check.

9.2 MOUNTING THE RADIO

9.2.1 Supplied Mounting Bracket

The supplied mounting bracket allows overhead or desktop mounting.

Use a 13/64" (5.2-mm) bit to drill the holes to a surface which is more 0.4 inch (10 mm) thick and can support more than 3.3 lbs (1.5 kg). Secure the bracket with the supplied screws, spring washers, flat washers, and nuts.

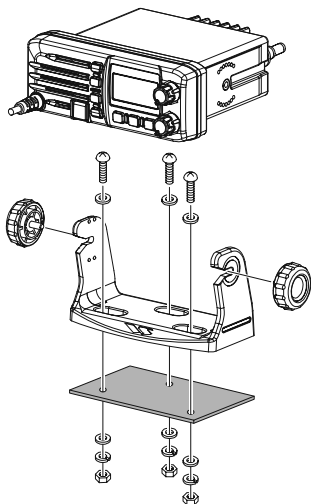

Desktop Mounting

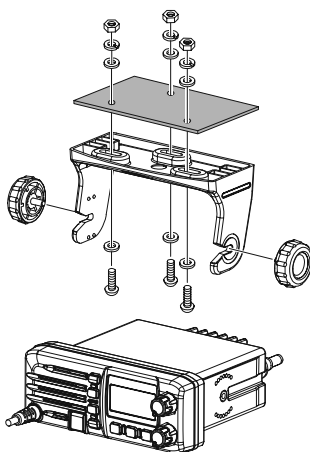

Overhead Mounting

9.2.2 Optional MMB-84 Flush Mount Bracket

1. To assist in flush mounting, a template has been included. Use this template to assess the mounting location.
2. Use the template to mark the location where the rectangular hole is to be cut. Confirm the space behind the dash or panel is deep enough to accommodate the transceiver (at least 6.7 inches or 17 cm deep). There should be at least 1/2 inch (1.3 cm) between the transceiver's heatsink and any wiring, cables or structures.
3. Cut out the rectangular hole and insert the transceiver.
4. Fasten the brackets to the sides of the transceiver with the lock washer nut combination, so that the mounting screw base faces the mounting surface.
5. Turn the adjusting screw to adjust the tension so that the transceiver is tight against the mounting surface.

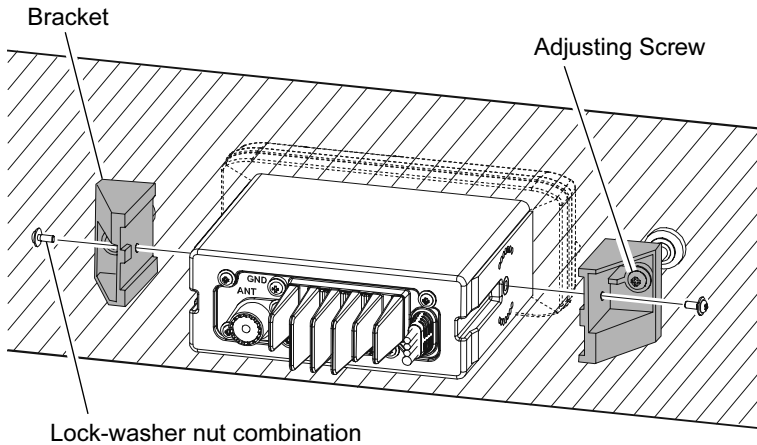

MMB-84 Flush Mount Installation

9.3 ELECTRICAL CONNECTIONS

CAUTION

Reverse polarity connections will damage the radio!

Connect the power cord and antenna to the radio. Antenna and Power Supply connections are as follows (see Figure 1):

1. Mount the antenna at least 1 m away from the radio. At the rear of the radio, connect the antenna cable.
2. Connect the red power wire to a 13.8 VDC $\pm 20\%$ power source. Connect the black power wire to a negative ground.
3. If an optional remote extension speaker is to be used, refer to next section for connections.
4. It is advisable to have a Certified Marine Technician check the power output and the standing wave ratio of the antenna after installation.

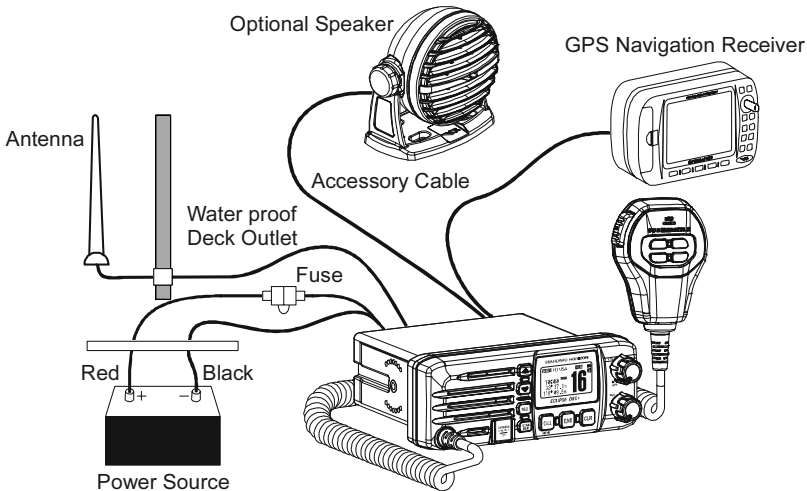
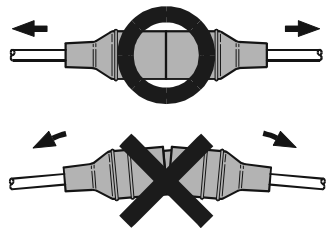

Figure 1. General Installation

Fuse Replacement

To take out the Fuse from the Fuse Holder, hold both ends of the Fuse Holder and pull the Fuse Holder apart, do not bend the Fuse Holder. When you replace the Fuse, please confirm that the Fuse is tightly fixed on the metal contact located inside the Fuse Holder. If the metal contact holding the fuse is loose, the Fuse holder may heat up.



9.4 ACCESSORY CABLE

Wire Color/Description	Connection Examples
WHITE - External Speaker (+)	Connect to external 4 Ohm audio speaker
SHIELD - External Speaker (-)	Connect to external 4 Ohm audio speaker
BLUE- NMEA Input (+)	Connect to NMEA (+) output of GPS
GREEN - NMEA Common or Ground	Connect to NMEA ground of GPS
PURPLE - NMEA Output (+)	Connect to NMEA (+) input of GPS

When connecting the external speaker or GPS navigation receiver, strip off about 1 inch (2.5 cm) of the specified wire's insulation, then splice the ends together using proper waterproofing techniques.

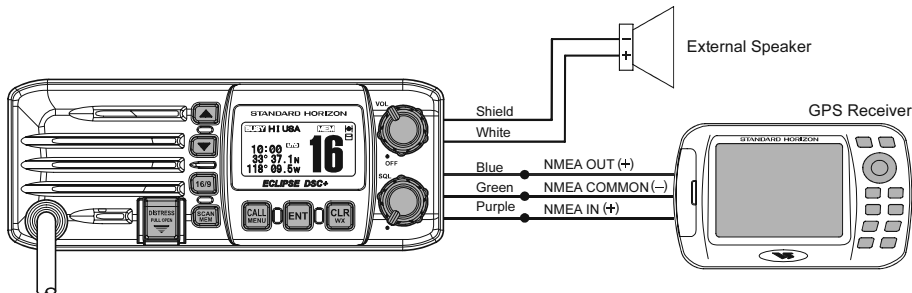

- The GPS must have the NMEA Output turned on and set to 4800 Baud in the setup menu. If there is a selection for parity select none.
- For further information on interfacing /setting up your GPS. Please contact the manufacturer of the GPS receiver.
- **GX1150** can read NMEA-0183 version 2.0 or higher.
- The NMEA supported sentences are:
 Input: GLL, GGA, RMC and GNS (RMC sentence is recommended)
 Output: DSC and DSE

9.5 CHECKING GPS CONNECTIONS

After connections have been made between the **GX1150** and the GPS, a small satellite icon will appear on the top right corner of the display, and displays your current location (Latitude/Longitude) on the display.

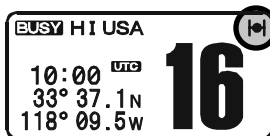

NOTE

- If there is a problem with the NMEA input from a GPS, the satellite icon will blink continuously until the connection is corrected.
- If a GPS with NMEA output is not connected to the radio, the **GX1150** will beep 10 minutes after the radio is turned on. After that the **GX1150** will beep every 4 hours alerting to connect a GPS.

9.6 CHANGING THE GPS TIME

From the Factory the **GX1150** shows GPS satellite time or UTC time. A time offset is needed to show the local time in your area.

1. Press and hold down the **CALL MENU** key until "SETUP MENU" appears.
2. Press the **ENT** key, then select "TIME OFFSET" with the **▲** / **▼** keys.
3. Press the **ENT** key.
4. Press the **▲** / **▼** keys to select time offset from UTC. See illustration below to find your offset time from UTC. If "00:00" is assigned, the time is the same as UTC (Universal Time Coordinated or GMT Greenwich Mean Time).
5. Press the **ENT** key to store the time offset.
6. Press the **16/9** key to exit the menu mode and return to radio operation.

```

-SETUP MENU-
▶RADIO SETUP
DSC SETUP
POS INPUT
So t>[ENT]  Quit>[CLR]
    
```

```

-RADIO SETUP-
DIMMER
CONTRAST
▶TIME OFFSET ▼
So t>[ENT]  Quit>[CLR]
    
```

```



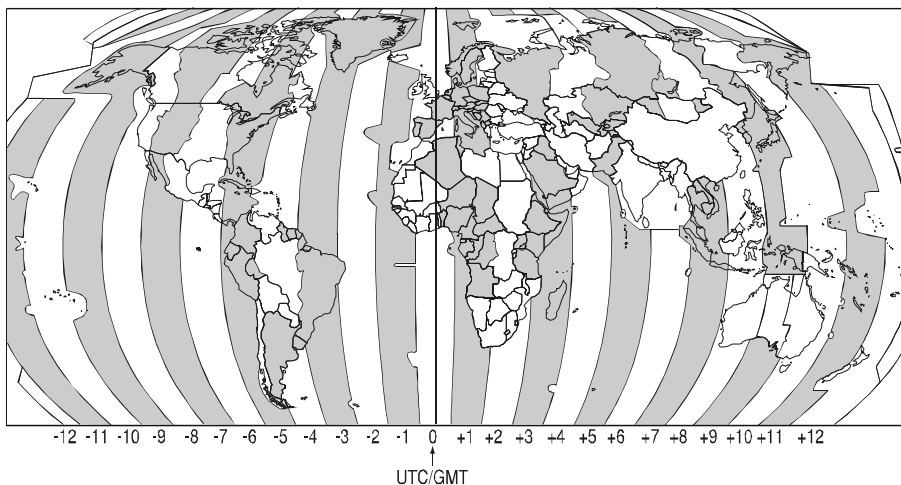





-TIME OFFSET-
+01:00 ▲
+00:30
▶00:00 ▼
So t>[ENT]  Quit>[CLR]
    
```



OFFSET TIME TABLE

9.7 CHANGING THE TIME LOCATION

This menu item allows you to choose to show UTC or the local time which is selected in Section 9.6.

1. Press and hold down the  key until "SETUP MENU" appears.
2. Press the  key, then select "TIME DISPLAY" with the  /  keys.
3. Press the  key.
4. Press the  /  to select "UTC" or "LOCAL".
5. Press the  key to store the selected setting.
6. Press the  key to exit the menu mode and return to radio operation.

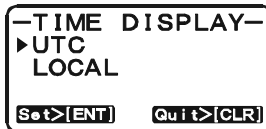

In the Local time mode, the display shows the time by the 12-hour system. Meanwhile, the display shows the time by 24-hour system in the UTC time mode.

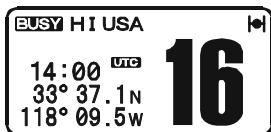

("UTC" mode)

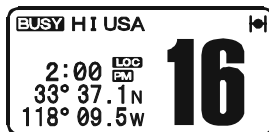

("LOCAL" mode)

10 CONTROLS AND INDICATORS

Front Panel

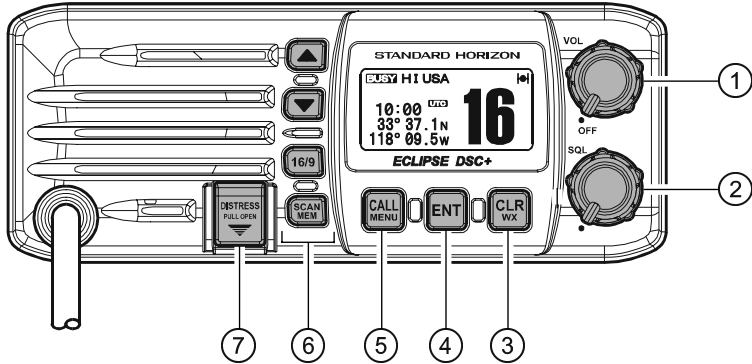

① POWER SWITCH / VOLUME CONTROL (VOL/PWR)

Turns the transceiver on and off as well as adjusts the audio volume. Turn this knob clockwise to turn the radio on and to increase the speakers audio volume level. Turn fully counter-clockwise to turn the radio off.

② SQUELCH CONTROL (SQL)

Adjusting this control clockwise, sets the point at which random noise on the channel does not activate the audio circuits but a received signal will. This point is called the squelch threshold. Further adjustment of the squelch control will degrade reception of wanted transmissions.

③ CLR WX Key

Press the CLR WX key to cancel the menu selection.

Secondary use

Press and hold the CLR WX key to recall the last-used NOAA (National Oceanic and Atmospheric Administration) Weather Channel from any channel location. Recalls the previously-selected working channel when you press and hold the CLR WX key again.

④ ENT Key

Press the ENT Key to determine the menu selection.

5  Key

Press the  key to access the “DSC MENU”. The “INDIVIDUAL CALL”, “GROUP CALL”, “ALL SHIPS CALL”, “POS REQUEST”, “POS REPORT”, “DSC LOG”, and “DSC TEST” functions can be accessed from the “DSC MENU”.

NOTE



Before the “DSC MENU” menu can be selected a MMSI must be entered. Refer to section “**12.2 MARITIME MOBILE SERVICE IDENTITY (MMSI).**”

Secondary use

Press and hold the  key to access the “SETUP MENU”. The “RADIO SETUP” (refer to section “**13 RADIO SETUP**”), “DSC SETUP”, “POS INPUT”, and “MMSI SETUP” functions can be accessed from the “SETUP MENU”.

6 **KEYPAD**



 /  Keys

The  and  keys are used to select a desired channel and to select items in the DSC OPERATION and SETUP menus.

 Key

Immediately recalls channel 16 from any channel location and automatically selects high power. Holding down this key recalls channel 9. Pressing the  key again reverts to the previous selected working channel.

Secondary use

Press and hold the  key then press the  key to switch between the USA, Canadian, and International Channel Groups.

 Key

Press this key to start and stop the scanning of programmed channels. Refer to section “**11.7 SCANNING**” for details.

Secondary use

To add a channel into the scan memory, select the channel and press and hold the  key until “MEM” is shown on the display.

To delete a memorized channel from scan memory, select the channel and press and hold the  key until “MEM” is removed from the display.

7 **[DISTRESS]** Key

Used to send a DSC Distress Call. To send the distress call refer to section “**12.3.1 Transmitting a Distress Alert**”.

Rear Panel

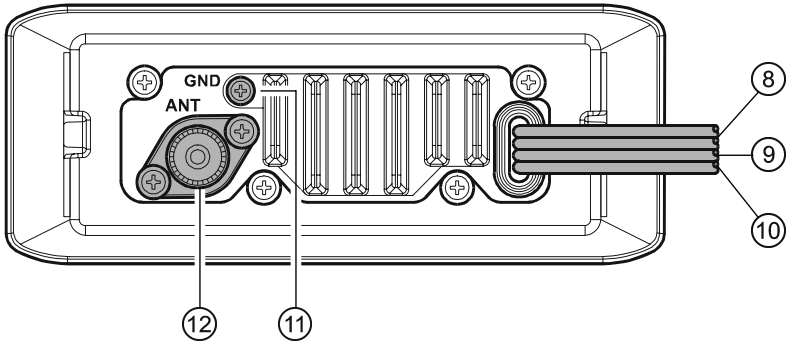

⑧ DC INPUT CABLE

Connects the radio to a DC power supply capable of delivering 12V DC.

⑨ EXTERNAL SPEAKER CONNECTION CABLE

Connects the **GX1150** to an external speaker.

⑩ GPS RECEIVER CONNECTION CABLE

Connects the **GX1150** to a GPS receiver.

⑪ GND TERMINAL

Connects the **GX1150** to a good ground, for safety and optimum performance.

Normally, the **GND** connection to the heat sink is not needed. However, when the DC power cable connection to the radio has a long run, the transmitter may become unstable and the receiving audio may be noisy. In such a case, connect a large diameter, short cable between this terminal on the heat sink and battery ground.

Install only the supplied screw or similar size (M3x6, Stainless Steel) screw.

⑫ ANTENNA JACK

Connects an antenna to the transceiver. Use a marine VHF antenna with an impedance of 50 ohms.

Microphone

- ⑬ **PTT (Push-To-Talk) SWITCH**
Keys the transmitter when the transceiver is in radio mode.

- ⑭ **▲ / ▼ KEYS**
The ▲ and ▼ keys on the microphone function the same as the ▲ and ▼ keys on the front panel of the transceiver.

- ⑮ **MICROPHONE**
Transmits the voice message with reduction of background noise, using Clear Voice Noise Reduction Technology.

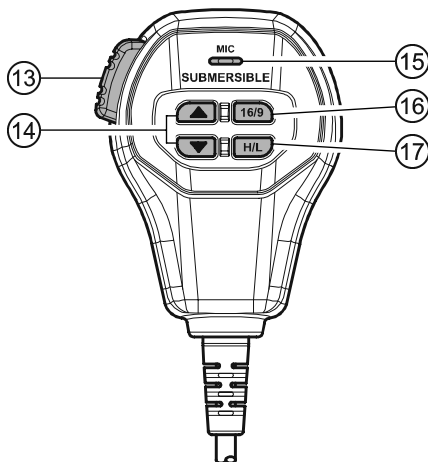

NOTE

Be sure your mouth is about 1/2 inch (1.3 cm) from the mic hole for best performance.

- ⑯ **16/9 Key**
The 16/9 key on the microphone functions the same as the 16/9 key on the front panel of the transceiver.
Immediately recalls channel 16 from any channel location. Holding down this key recalls channel 9. Pressing the 16/9 key again reverts to the previously selected working channel.



- ⑰ **H/L Key**
Press this key to toggle the transmit output power between 25 W (High) and 1 W (Low) power. When the H/L key is pressed while the transceiver is on channel 13 or 67, the power will temporarily switch from LO to HI power until the PTT is released.
The H/L key does not function on transmit inhibited and low power only channels.

NOTE

1W low power is indicated by LO on the display. When 25W high power is selected the display do not show an indication.

11 BASIC OPERATION

11.1 RECEPTION

1. After the **GX1150** has been installed, ensure that the power supply and antenna are properly connected.
2. Turn the **VOL/PWR** knob clockwise to turn the transceiver on.
3. Turn the **SQL** knob fully counterclockwise. This state is known as “squelch off”.
4. Turn up the **VOL** knob until noise or audio from the speaker is at a comfortable level.
5. Turn the **SQL** knob clockwise until the random noise disappears. This state is known as the “squelch threshold.”
6. Press the  or  keys to select the desired channel. Refer to the channel chart on page 70 for available channels.
7. When a message is received, adjust the volume to the desired listening level. The “**BUSY**” indicator on the LCD is displayed indicating that the channel is being used.

11.2 TRANSMISSION

1. Perform steps 1 through 6 of RECEPTION.
2. Before transmitting, monitor the channel to ensure it is clear.
THIS IS AN FCC REQUIREMENT!
3. Press the **PTT** (push-to-talk) switch. The “**T X**” indicator in the LCD is displayed.
4. Speak slowly and clearly into the microphone.

NOTE

This is a noise cancelling microphone. The oval slot on the microphone should be positioned within 1/2 inch (1.3 cm) from the mouth for optimum performance.

5. When the transmission is finished, release the **PTT** switch.

11.3 TRANSMIT TIME - OUT TIMER (TOT)

When the **PTT** switch on the microphone is held down, transmit time is limited to 5 minutes. This limits unintentional transmissions due to a stuck microphone. About 10 seconds before automatic transmitter shutdown, a warning beep will be heard from the speaker(s). The transceiver will automatically go to receive mode, even if the **PTT** switch is continually held down. Before transmitting again, the **PTT** switch must first be released and then pressed again.

NOTE

When a transmission was shut down by the TOT, the **GX1150** can not transmit afterwards for 10 seconds.



11.4 SIMPLEX/DUPLEX CHANNEL USE

Refer to the VHF MARINE CHANNEL CHART (page 70) for instructions on use of simplex and duplex channels.

NOTE

All channels are factory-programmed in accordance with International, Industry Canada (Canada), and FCC (USA) regulations. Mode of operation cannot be altered from simplex to duplex or vice-versa.

11.5 USA, INTERNATIONAL, AND CANADA MODE

1. To change the modes, hold the  key and press the  key. The mode changes from “USA” to “International” to “Canadian” with each press of the  key.
2. “USA” will be shown on the display for USA mode, “INTL” will be shown for International mode, and “CAN” will be shown for Canadian mode.
3. Refer to the VHF MARINE CHANNEL CHART (page 70) for allocated channels in each mode.

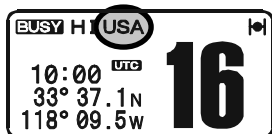

USA MODE

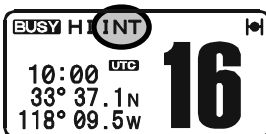

INTERNATIONAL MODE

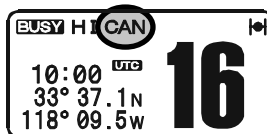





CANADIAN MODE

11.6 NOAA WEATHER CHANNELS

NOTE

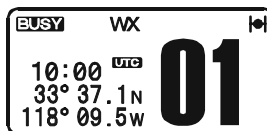

NOAA Weather channels are available in the waters of USA and Canada only.

1. To receive a NOAA weather channel, press and hold the  key from any channel. The transceiver will go to the last selected weather channel.
2. Press the  /  keys to select a different NOAA weather channel.
3. To exit from the NOAA weather channels, press and hold the  key. The transceiver returns to the channel it was on prior to a weather channel.



11.6.1 NOAA Weather Alert

In the event of extreme weather disturbances, such as storms and hurricanes, the NOAA (National Oceanic and Atmospheric Administration) sends a weather alert accompanied by a 1050 Hz tone and subsequent weather report on one of the NOAA weather channels. When the Weather Alert feature is enabled (see section “13.8 WX ALERT”), the transceiver is capable of receiving this alert if the following is performed:

1. Program NOAA weather channels into the transceiver's memory for scanning. Follow the same procedure as for regular channels under section "11.7 SCANNING."
2. Press the  key once to start memory scanning or priority scanning (determined from the "RADIO SETUP" selection, see page 63 for details).
3. The programmed NOAA weather channels will be scanned along with the regular-programmed channels. However, scanning will not stop on a normal weather broadcast unless a NOAA alert is received.
4. When an alert is received on a NOAA weather channel, scanning will stop and the transceiver will emit a loud beep to alert the user of a NOAA broadcast.
5. Press the  key to stop the alert tone and receive the weather report.

NOTE

- If the  key is not pressed the alert tone will be emitted for 5 minutes and then the weather report will be received.
- The Weather Alert feature is also engaged while the transceiver is receiving on one of the NOAA weather channels.









11.6.2 NOAA Weather Alert Testing

NOAA tests the alert system every Wednesday between 11AM and 1PM. To test the **GX1150's** NOAA Weather alert feature, on Wednesday between 11AM and 1PM, setup as in previous section and confirm the alert is heard.

11.7 SCANNING

Allows the user to select the scan type from Memory scan or Priority scan. "Memory scan" scans the channels that were programmed into memory. "Priority scan" scans the channels programmed in memory with the priority channel.

11.7.1 Selecting the Scan Type

1. Press and hold down the  key until "SETUP MENU" appears.
2. Press the  key, then select "SCAN TYPE" in the "RADIO SETUP" menu with the  /  keys.
3. Press the  key.
4. Press the  /  keys to select "PRIORITY SCAN" or "MEMORY SCAN."
5. Press the  key to store the selected setting.
6. To exit this menu and return to radio operation mode press the  key.

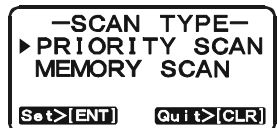
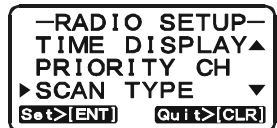
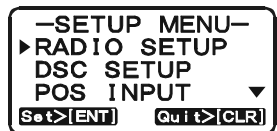

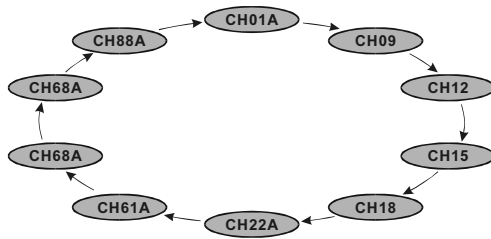

MEMORY SCAN (M-SCAN)

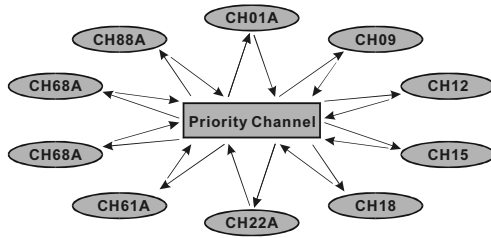

PRIORITY SCAN (P-SCAN)





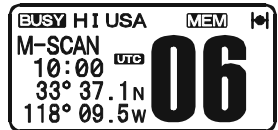
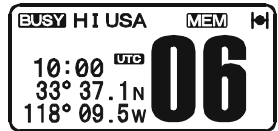

11.7.2 Memory Scanning (M-SCAN)

1. Adjust the **SQL** knob until background noise disappears.
2. Select a desired channel to be scanned using the / keys.
3. Press and hold the key until “MEM” is shown on the LCD which indicates the channel has been programmed into the transceiver's memory.
4. Repeat steps 2 and 3 for all the desired channels to be scanned.
5. To DELETE a channel from the transceiver's memory, select the channel then press and hold the key until “MEM” disappears from the LCD.
6. To start scanning, just press the key momentarily. “M-SCAN” appears on the LCD. Scanning will proceed from the lowest to the highest programmed channel number and will stop on a channel when a transmission is received.
7. The channel number will blink during reception.
8. To stop scanning, press the or key.









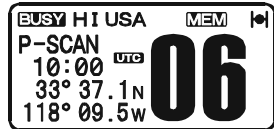
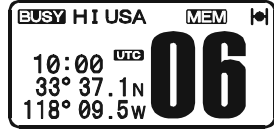

11.7.3 Priority Scanning (P-SCAN)

In the default setting, Channel 16 is set as the priority channel. You may change the priority channel to another channel from Channel 16 in the Radio Setup Mode, refer to section “13.5 PRIORITY CHANNEL SET.”

1. Adjust the **SQL** knob until background noise disappears.
2. Select a desired channel to be scanned using the  /  keys.
3. Press and hold the  key until “MEM” is shown on the display which indicates the channel has been programmed into the transceivers memory.
4. Repeat step 2 for all the desired channels to be scanned.
5. To DELETE a channel from the transceiver’s memory, select the channel then press and hold the  key until “MEM” disappears from the LCD.
6. To start priority scanning, just press the  key momentarily. “P-SCAN” appears on the LCD. Scanning will proceed between the memorized channels and the priority channel. The priority channel will be scanned after each programmed channel.
7. To stop scanning, press the  or  key.





11.7.4 Priority Channel Setting

1. Press and hold down the  key until “SETUP MENU” appears.
2. Press the  key, then select “PRIORITY CH” in the “RADIO SETUP” menu with the  /  keys.
3. Press the  key.
4. Press the  /  keys to select the Priority channel.
5. Press the  key to store the selected setting.
6. Press the  key to exit the menu mode and return to radio operation.



11.7.5 Dual Watch

Dual watch is similar to priority scanning; however instead of multiple channels being selected into memory, only one channel is selected.

1. Select Priority scan mode, refer to section “11.7.1 Selecting the Scan Type.”
2. By default the Priority Channel is set to Channel 16. If you want to select a different channel the radio will Dual Watch to, refer to section “11.7.4 Priority Channel Setting”.
3. Select the channel you wish to Dual Watch along with the priority channel.
4. Press and hold the  key until “MEM” is shown on the display.
5. Press the  key and the radio will Dual Watch between the selected priority channel and the channel selected in step 3.

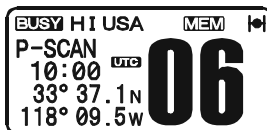
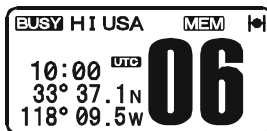

12 DIGITAL SELECTIVE CALLING

12.1 GENERAL

WARNING

This radio is designed to generate a digital maritime distress and safety call to facilitate search and rescue. To be effective as a safety device, this equipment must be used only within communication range of a shore-based VHF marine channel 70 distress and safety watch system. The range of signal may vary but under normal conditions should be approximately 20 nautical miles.

Digital Selective Calling is a semi-automated method of establishing a radio call. It has been designated by the International Maritime Organization (IMO) as an international standard for establishing VHF, MF, and HF radio calls. It has also been designated as part of the Global Maritime Distress and Safety System (GMDSS). It is planned that DSC will eventually replace aural watches on distress frequencies and will be used to announce routine and urgent maritime safety information broadcasts.

This system allows mariners to instantly send a distress call with GPS position (when connected to the transceiver) to the Coast Guard and other vessels within range of the transmission. DSC will also allow mariners to initiate or receive Distress, Urgency, Safety, Routine, POSITION REQUEST, POSITION SEND, and Group calls to or from another vessel equipped with a DSC transceiver.

12.2 MARITIME MOBILE SERVICE IDENTITY (MMSI)

12.2.1 What is an MMSI?

An MMSI is a nine digit number used on Marine radios capable of using Digital Selective Calling (DSC). This number is used like a telephone number to selectively call other vessels.

THIS NUMBER MUST BE PROGRAMMED INTO THE RADIO TO OPERATE DSC FUNCTIONS.

How can I obtain an MMSI assignment?

In the USA, visit the following websites to register:

<http://www.boatus.com/mmsi/> or

http://seatow.com/boating_safety/mmsi.asp

In the Canada, visit







<http://www.ic.gc.ca/epic/site/smt-gst.nsf/en/sf01032e.html> or

<http://www.usps.org/php/mmsi/rules.php>



12.2.2 Programming the MMSI



WARNING

A User MMSI can be input only once. Therefore, *please be careful not to input the incorrect MMSI number.* If you need to change the MMSI number after it has been entered, the radio will have to be returned to Factory Service. Refer to the section “**14.2 FACTORY SERVICE.**”

1. Press and hold down the  key until the “SETUP MENU” appears.
2. Press the  key repeatedly until the “MMSI SETUP” menu appears.
3. Press the  key. The display will show a series of dashes.
4. Press the  /  keys to select the first number of your MMSI, then press the  key to step to the next number.
5. Repeat step 4 to set your MMSI (up to nine digits).

NOTE

If a mistake was made, pressing the  key on the microphone will step to previously entered numbers and will allow the number to be changed using the  /  keys.

6. When finished programming the number, press and hold the  key. A confirmation message appears on the display. Input your MMSI again, then press and hold the  key.
7. Press the  key to store the number in memory and return to radio operation mode.

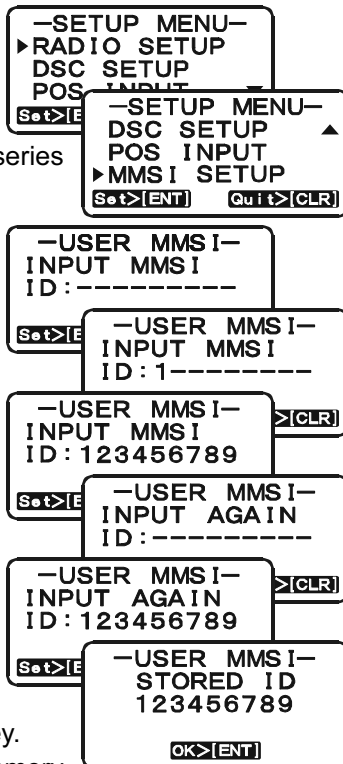

12.3 DISTRESS ALERT

The **GX1150** is capable of transmitting and receiving DSC Distress messages to all DSC radios. The **GX1150** may be connected to a GPS to also transmit the Latitude and Longitude of the vessel.

NOTE

If a GPS with NMEA output is not connected to the radio, the **GX1150** will beep 10 minutes after the radio is turned on. After that the **GX1150** will beep every 4 hours alerting to connect a GPS.

12.3.1 Transmitting a Distress Alert

NOTE

To be able to transmit a Distress Alert an MMSI number must be programmed, refer to section “**12.2.2 Programming the MMSI.**”

In order for your vessels location to be transmitted either connect a GPS to the **GX1150** (refer to section “**9.4 ACCESSORY CABLE**”) or manually input your position (refer to section “**12.11 MANUAL INPUTTING OF THE GPS LOCATION**”).

1. Lift the red spring loaded DISTRESS cover, then press and hold the **[DISTRESS]** key. The “DISTRESS” menu will appear on the LCD and the radios display will count down (3S → 2S → 1S) and then transmit the Distress Alert. The backlight of the LCD and keypad flashes while the radios display is countdown.

```
!!DIST INFO!!
▶ UNDESIGNATED
  33° 37.1N
 118° 09.5W
[Edit] > [ENT]  [Quit] > [CLR]
```

2. The **GX1150** watches for an acknowledgment call on channel 70 or a voice call on channel 16 from another vessel.

```
!!DISTRESS!!
UNDESIGNATED
TIME FOR 3S
```

3. If an vessel responds to you on channel 16, pick up the mic and advise your distress situation.

```
!!DISTRESS!!
TRANSMITTING
TX IN 00:00
```

4. When a DSC Distress acknowledgment is received on channel 70, a DSC Distress Alarm sounds and channel 16 is automatically selected. Pick up the mic and advise your distress situation. The LCD shows the MMSI of the ship responding to your distress.

```
!!DISTRESS!!
WAIT FOR ACK
TX IN 4:00
[Quit] > [CLR]
```

RECEIVED ACK: acknowledgment signal is received.

RECEIVED RLY ACK: relay acknowledgment signal is received from another vessel or coast station.

5. If no acknowledgment is received, the Distress Alert is repeated at approximately 4 minute intervals until a DSC acknowledgment is received.
6. To cancel the DSC Distress Alarm signal from the speaker, press any key.

Transmitting a Distress Alert with Nature of Distress

The **GX1150** is capable of transmitting a Distress Alert with the following “Nature of Distress” categories:

Undesignated, Fire, Flooding, Collision, Grounding, Capsizing, Sinking, Adrift, Abandoning, Piracy, Mob

1. Lift the red spring loaded DISTRESS cover and press the [DISTRESS] key. The “DISTRESS” menu will appear on the LCD.

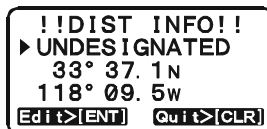

2. Press the [ENT] key.
3. Press the [▲] / [▼] keys to select the desired nature of distress category, then press the [ENT] key.
4. Press and hold the [DISTRESS] key. The radios display will count down (3S → 2S → 1S) and then transmit the Distress Alert. The backlight of the LCD and keypad flashes while the radios display is countdown.



5. The transceiver will watch for a DSC acknowledgment transmission on CH70 and also receive calls on CH16.

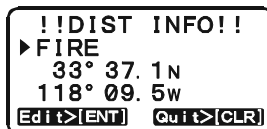

6. If an vessel responds to you on channel 16, pick up the mic and advise your distress situation.

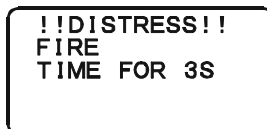

7. When a DSC Distress acknowledgment is received on channel 70, a DSC Distress alarm sounds and channel 16 is automatically selected. Pick up the mic and advise your distress situation. The LCD shows the MMSI of the ship responding to your distress.

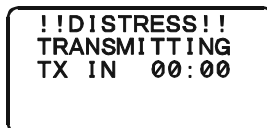

RECEIVED ACK: acknowledgment signal is received.

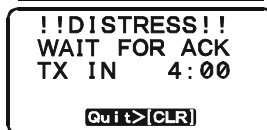



RECEIVED RLY ACK: relay acknowledgment signal is received from another vessel or coast station.

8. If an acknowledgment is received, select channel 16 and advise your distress situation.
9. To cancel the DSC distress alarm signal from the speaker, press any key.

NOTE



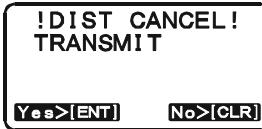

After the radio transmits the DSC call, the display of the radio will show the next time the Distress call will be transmitted. The display will show TX IN 4:00 and count down until the distress call is transmitted.

Cancel a Distress Alert

The **GX1150** has the capability to transmit a DSC Distress cancel call by, pressing the  key, then press the  key.



12.3.2 Receiving a Distress Alert

1. When a Distress Alert is received, an emergency alarm sounds.
The display will show the MMSI (or name) of the vessel transmitting the Distress.
2. Press any of the keys on the radio to stop the alarm.
3. To show the nature of distress and GPS position of the vessel in distress, press the  key.
4. If a key is not pressed for thirty seconds after a DSC call is received, the **GX1150** will automatically switch to channel 16 for you to monitor distress communications.
5. To immediately switch to channel 16, press the  key.
6. If you want the radio to stay on the channel you were on before receiving the distress call, press the  key.
7. If the position of the vessel distress data does not include position, the LCD will show "NO POSITION".
8. Press the  key to return to radio operation mode.

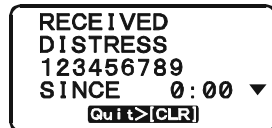
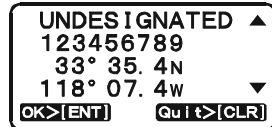
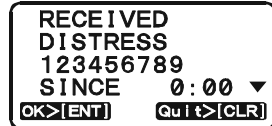

NOTE

When there is an unread Distress Alert, "☐" icon will appear on the display. You may review the unread Distress Alert from the DSC Log, refer to section "**12.6.2 Reviewing Received Calls Logged into the Call Waiting Directory.**"













12.4 ALL SHIPS CALL

The All Ships Call function allows contact to be established with other vessel stations without having their ID in the individual calling directory. Also, priority for the call can be designated as Urgency or Safety.

URGENCY Call: This type of call is used when a vessel may not truly be in distress, but have a potential problem that may lead to a distress situation. This call is the same as saying PAN PAN PAN on channel 16.

SAFETY Call: Used to transmit boating safety information to other vessels. This message usually contains information about an overdue boat, debris in the water, loss of a navigation aid or an important meteorological message. This call is the same as saying Securite, Securite, Securite.”

12.4.1 Transmitting an All Ships Call

1. Press the  key. The “DSC MENU” will appear.
2. Press the  /  keys to select “ALL SHIPS.”
3. Press the  key. (To cancel, press the  key)
4. Press the  /  keys to select the call (“SAFETY” or “URGENCY”), then press the  key.
5. Press the  /  keys to select the operating channel you want to communicate on, then press the  key.
6. Press the  key again to transmit the selected call type of ALL SHIPS CALL.
7. After the ALL SHIPS CALL is transmitted, the transceiver will switch to the channel which selected on step 5 above (but, the display will not change. To change the display, press the  key).
8. Listen to the channel to make sure it is not busy, then key the microphone and say PAN PAN PAN or “Securite, Securite, Securite” depending on the priority of the call. Say your call sign and announce the channel you wish to switch to for communications.

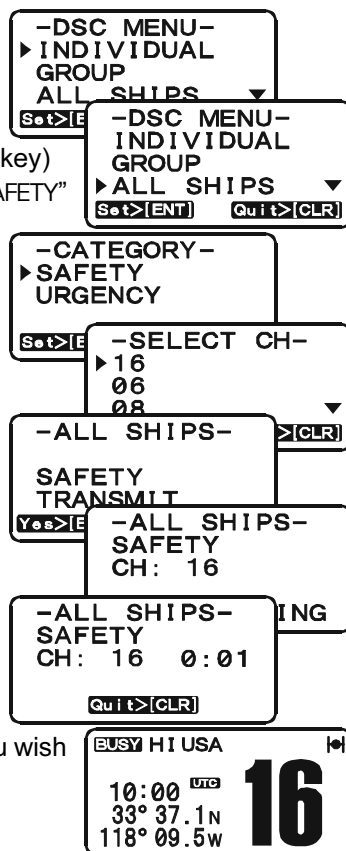

12.4.2 Receiving an All Ships Call

1. When an All Ships Call is received, an emergency alarm sounds.

The display will show the MMSI (or name) of the vessel transmitting the All Ships Call.



RECEIVED
ALL SHIPS
VERTEX
SINCE 0:01 ▾
OK>[ENT] Quit>[CLR]

2. Press any of the keys on the radio to stop the alarm.

3. To show the nature of the call of the vessel, press the  key.



VERTEX ▲
SINCE 0:01
SAFETY
CH: 16
OK>[ENT] Quit>[CLR]

4. If a key is not pressed for thirty seconds after an All Ships call is received, the **GX1150** will automatically switch to the requested channel for you to monitor communications.

5. To immediately switch to requested channel, press the  key.

6. If you want the radio to stay on the channel you were on before receiving the All Ships call, press the  key.



RECEIVED
ALL SHIPS
VERTEX
SINCE 0:01 ▾
Quit>[CLR]

7. Press the  key to display the operating channel number of the requested channel.

8. Press the **PTT** switch on the microphone and talk to the calling ship.

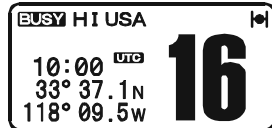

BUSY HI USA 
10:00 UTC
33° 37.1N
118° 09.5W **16**



















12.5 INDIVIDUAL CALL

This feature allows the **GX1150** to contact another vessel with a DSC VHF radio and automatically switch the receiving radio to a desired communications channel. This feature is similar to calling a vessel on CH16 and requesting to go to another channel (switching to the channel is private between the two stations).

12.5.1 Setting up the Individual / Position Call Directory

The **GX1150** has a DSC directory that allows you to store a vessel or person's name and the MMSI number associated with vessels you wish to transmit Individual calls, Position Requests and Position Send transmissions. The **GX1150** can store up to 48 vessels or person names.

To transmit an Individual call you must program this directory with the information of the persons you wish to call, similar to a cellular phones directory.

1. Press and hold down the  key until "SETUP MENU" appears.
2. Press the  /  keys to select "DSC SETUP" menu.
3. Press the  key, then select "INDIV DIR" with the  /  keys.
4. Press the  key, then select "ADD" with the  /  keys.
5. Press the  key.
6. Press the  /  keys to scroll to the first letter of the name of the vessel or person you want to list in the directory.
7. Press the  key to store the first letter of the name and step to the next letter to the right.
8. Repeat step 6 and 7 until the name is complete. The name can consist of up to eleven characters, if you do not use all eleven characters press the  key to move to the next space. This method can also be used to enter a blank space in the name. To clear the previous letter, press the  key.
9. After the eleventh letter or space has been entered, press and hold the  key to advance to the MMSI number (Maritime Mobile Service Identity Number) entry.
10. Press the  /  keys to scroll through numbers, 0-9. To enter the desired number and move



—SETUP MENU—
▶RADIO SETUP
DSC SETUP
POS INPUT
So t>[ENT] Qui t>[CLR]



—SETUP MENU—
RADIO SETUP
▶DSC SETUP
POS INPUT
So t>[ENT] Qui t>[CLR]



—DSC SETUP—
▶INDIVI DIR
INDIVI REPLY
INDIVI ACK
So t>[ENT] Qui t>[CLR]



—INDIVI DIR—
▶ADD
EDIT
DELETE
So t>[ENT] Qui t>[CLR]

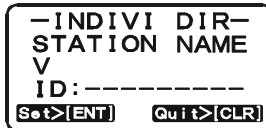

—INDIVI DIR—
STATION NAME
V
ID:-----
So t>[ENT] Qui t>[CLR]







—INDIVI DIR—
STATION NAME
VERTEX
ID:-----
So t>[ENT] Qui t>[CLR]



—INDIVI DIR—
STATION NAME
VERTEX
ID: 1-----
So t>[ENT] Qui t>[CLR]











one space to the right press the  key. Repeat this procedure until all nine spaces of the MMSI number are entered.

11. If a mistake was made entering in the name or the MMSI number, press the microphone's  key repeatedly until the wrong character is selected, then press the  /  keys to correct the entry.
12. To store the data entered, press and hold the  key.
13. To enter another individual address, repeat steps 4 through 12.
14. To exit this menu and return to radio operation mode press the  key.



12.5.2 Setting up Individual Reply





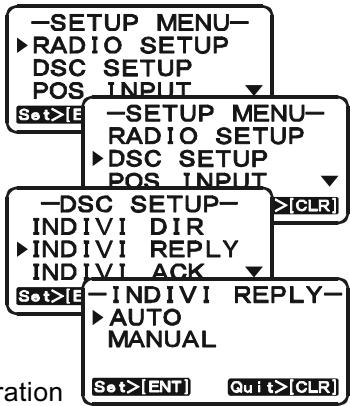





Allows setting up the radio to automatically (default setting) or manually respond to a DSC Individual call requesting you to switch to a working channel for voice communications. When Manual is selected the MMSI of the calling vessel is shown allowing you to see who is calling. This function is similar to caller id on a cellular phone.

1. Press and hold down the  key until "SETUP MENU" appears.
2. Press the  /  keys to select "DSC SETUP" menu.
3. Press the  key, then select "INDIV REPLY" with the  /  keys.
4. Press the  key.
5. Turn the  /  keys to select "AUTO" or "MANUAL."
6. Press the  key to store the selected setting.
7. To exit this menu and return to radio operation mode press the  key.



12.5.3 Setting Up the Individual Acknowledge Message





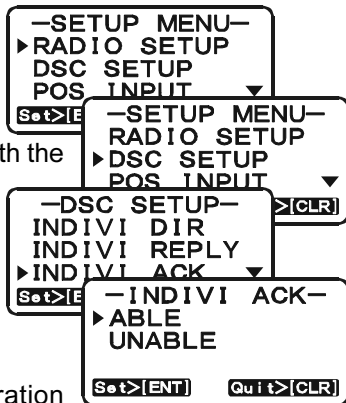





The **GX1150** can select either reply message “Able” (default) or “Unable” when the Individual Reply setting (described previous section) is set to “AUTO”.

1. Press and hold down the  key until “SETUP MENU” appears.
2. Press the  /  keys to select “DSC SETUP” menu.
3. Press the  key, then select “INDIV ACK” with the  /  keys.
4. Press the  key.
5. Turn the  /  keys to select “ABLE” or “UNABLE”.
6. Press the  key to store the selected setting.
7. To exit this menu and return to radio operation mode press the  key.









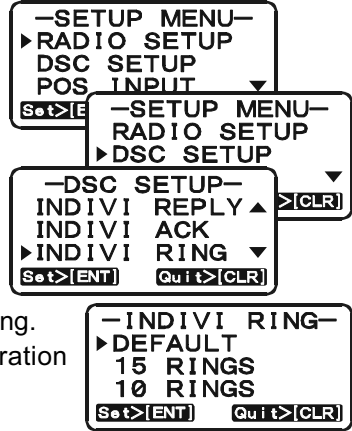







12.5.4 Setting up the Individual Call Ringer

When a Individual Call is received the radio will produce a ringing tone for 3 minutes. This selection allows the Individual Call ringer time to be changed.



1. Press and hold down the  key until "SETUP MENU" appears.
2. Press the  /  keys to select "DSC SETUP" menu.
3. Press the  key, then select "INDIV RING" with the  /  keys.
4. Press the  key.
5. Press the  /  keys to select ringing time of a Individual Call.
6. Press the  key to store the selected setting.
7. To exit this menu and return to radio operation mode press the  key.

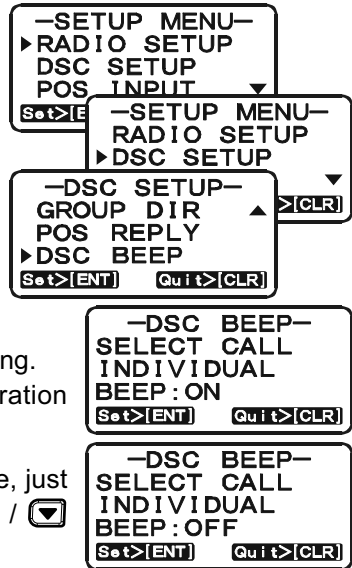

The **GX1150** has the capability to turn off the Individual call ringer.

1. Press and hold down the  key until "SETUP MENU" appears.
2. Press the  /  keys to select "DSC SETUP" menu.
3. Press the  key, then select "DSC BEEP" with the  /  keys.
4. Press the  key.
5. Press the  /  keys to select "INDIVIDUAL" then press the  key.
6. Press the  /  keys to select "OFF."
7. Press the  key to store the selected setting.
8. To exit this menu and return to radio operation mode press the  key.



















If you wish to return to enabling the ringer tone, just repeat the above procedure, pressing the  /  keys to select "ON" in step "6" above.

12.5.5 Transmitting an Individual Call

This feature allows the user to contact another vessel with a DSC radio and have the radio switch to another channel and ring like a telephone. This feature is similar to calling a vessel on CH16 and requesting to go to another channel.

Pre-Programmable Calling

1. Press the  key. The “DSC MENU” will appear.
2. Press the  /  keys to select “INDIVIDUAL”. (To cancel, press the  or  key.)
3. Press the  key. The transceiver will beep, and the “Individual directory” will appear.
4. Press the  /  keys to select the “Individual” you want to contact.
5. Press the  key, then press the  /  keys to select the operating channel you want to communicate on and press the  key.
6. Press the  key again to transmit the individual DSC signal.
7. After INDIVIDUAL CALL is transmitted, if the reply signal is not received, “WAIT FOR ACK” is shown on the display which means the **GX1150** is waiting for the ship you called to send an acknowledgement.
8. To transmit the call again, press the  key followed by the  key.
9. When the **GX1150** receives an acknowledgement from the vessel you called, the radio will automatically switch to the operating channel selected in step 5 and produce a ringing sound.
10. Press the  key to listen to the channel to make sure it is not busy, then key the microphone and call the other vessel you desire to communicate with.

```

-DSC MENU-
▶ INDIVIDUAL
  GROUP
  ALL SHIPS ▼
Set>[ENT]  Quit>[CLR]
  
```

```

-INDIVIDUAL-
▶ MANUAL
  VERTEX
  STANDARD ▼
Set>[ENT]  Quit>[CLR]
  
```

```

-INDIVIDUAL-
  MANUAL
▶ VERTEX
  STANDARD ▼
Set>[ENT]  Quit>[CLR]
  
```

```

-SELECT CH-
▶ 06
  08
  09 ▼
Set>[ENT]  Quit>[CLR]
  
```

```

-INDIVIDUAL-
  VERTEX
  ROUTINE
  TRANSMIT
Yes>[ENT]  No>[CLR]
  
```

```

-INDIVIDUAL-
  VERTEX
  ROUTINE
  CH: 06
  TRANSMITTING
  
```

```























-INDIVIDUAL-
  VERTEX
  WAIT FOR ACK
  SINCE 0:01
Quit>[CLR]
  
```

```

-INDIVIDUAL-
  VERTEX
  CONNECTED
  SINCE 0:01
Quit>[CLR]
  
```

Manual Calling

You may enter an MMSI number manually to contact without storing it in the Individual Directory.

1. Press the  key. The “DSC MENU” will appear.
2. Press the  /  keys to select “INDIVIDUAL”.
(To cancel, press the  or  key.)
3. Press the  key. The transceiver will beep, and the “Individual directory” will appear.
4. Press the  /  keys to select “MANUAL”, then press the  key.
5. Press the  /  keys to scroll through numbers, 0-9. To enter the desired number and move one space to the right, press the  key. Repeat this procedure until all nine spaces of the MMSI number which you want to contact are entered.
6. If a mistake was made entering in the MMSI number repeat pressing the microphone’s  key until the wrong number is selected, then move the channel knob to correct the entry.
7. When finished entering the MMSI number, press and hold the  key.
8. Press the  key, then press the  /  keys to select the operating channel you want to communicate on and press the  key.
9. Press the  key again to transmit the individual DSC signal.
10. After the INDIVIDUAL CALL is transmitted, if a reply signal is not received, “WAIT FOR ACK” is shown on the display which means the **GX1150** is waiting for the ship you called to send an acknowledgment.
11. To transmit the call again, press the  key followed by the  key.
12. When the **GX1150** receives an acknowledgement from the vessel you called, the radio will automatically switch to the operating channel selected in step 5 and produce a ringing sound.
13. Press the  key to listen to the channel to make sure it is not busy, then key the microphone and call the other vessel you desire to communicate with.

```
—DSC MENU—
▶ INDIVIDUAL
  GROUP
  ALL SHIPS ▼
Set>[ENT]  Quit>[CLR]
```

```
— INDIVIDUAL —
▶ MANUAL
  VERTEX
  STANDARD ▼
Set>[ENT]  Quit>[CLR]
```

```
— INDIVIDUAL —
INPUT MMSI
ID : -----
Set>[ENT]  Quit>[CLR]
```

```
— INDIVIDUAL —
INPUT MMSI
ID : 234567891
Set>[ENT]  Quit>[CLR]
```

```
—SELECT CH—
▶ 06
  08
  09 ▼
Set>[ENT]  Quit>[CLR]
```

```
— INDIVIDUAL —
234567891
ROUTINE
TRANSMIT
Yes>[ENT]  No>[CLR]
```



```
— INDIVIDUAL —
234567891
ROUTINE
CH : 06
TRANSMITTING
```

```
— INDIVIDUAL —
234567891
WAIT FOR ACK
SINCE 0 : 01
Quit>[CLR]
```

```
— INDIVIDUAL —
234567891
CONNECTED
SINCE 0 : 01
Quit>[CLR]
```

12.5.6 Receiving an Individual Call

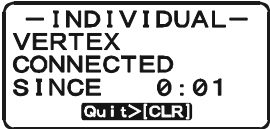
When receiving an individual call, an acknowledgment must be sent back to the calling station. The **GX1150** default setting is Automatic, but has a selection that allows you to manually send a reply before the radio will switch to the requested calling channel. This selection is useful if you want to see who is calling and requesting you to switch to a channel for communications, similar to caller id on a cellular phone.

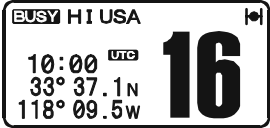
1. When an individual call is received, an individual call ringing alarm sounds. The display will show the MMSI (or name) of the vessel transmitting the Individual Call and the radio automatically switches to the requested channel.
2. Press any key to stop the alarm.
3. Press the  key to show the display of the operating channel number.
4. Press the **PTT** switch on the microphone and talk to the calling ship.

12.6 CALL WAITING DIRECTORY

The **GX1150** logs received Distress Calls and Individual Calls into the Call Waiting Directory for review at a later time. The DSC Call Waiting feature is similar to an answer machine where calls are recorded for review. When a call is logged while the radio is set on the DSC Standby function, a “☒” icon will appear on the display. The **GX1150** can store up to the latest 20 Distress and up to the latest 38 Individual Calls.

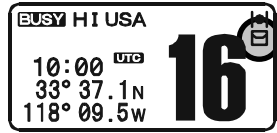

12.6.1 Enabling/Disabling the Call Waiting Feature

Follow the steps below to enable or disable the Call Waiting feature.

1. Press and hold down the key until “SETUP MENU” menu appears.
2. Press the / keys to select “DSC SETUP” menu.
3. Press the key, then select “INDIV ACK” with the / keys.
4. Press the key.
5. Press the / keys to select “ABLE” or “UNABLE”.
6. Press the key to store the selected setting.
7. To exit this menu and return to radio operation mode press the key.

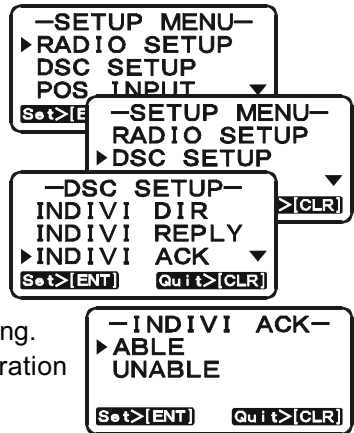

12.6.2 Reviewing Received Calls Logged into the Call Waiting Directory

1. Press the key. The “DSC MENU” will appear.
2. Press the / keys to select “DSC LOG” menu.
3. Press the key, then press the / keys to select the category (“DISTRESS” or “DSC CALL”) you want to review and/or call back.
4. Press the key, then press the / keys to select the category (DISTRESS or DIST CANCEL: for “DISTRESS”) or station (name or MMSI number: for “DSC CALL”) you want to review and/or call back.
5. Press the key, then press the / keys to review details for the selected category or station.

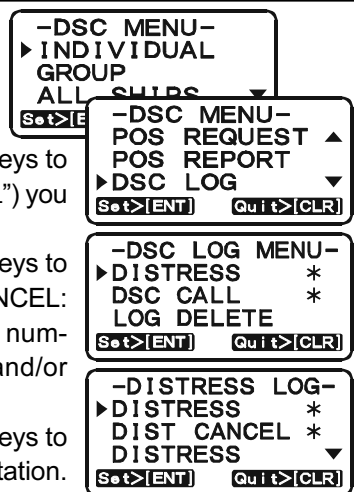

- If you review the DSC Call, press the **[ENT]** key again, to call the selected station if desired.
- To exit Call Waiting Directory and return to radio operation mode press the **[CLR]** key.

```

-DISTRESS LOG-
DISTRESS
VERTEX
10:00
  
```

```

-DISTRESS LOG-
33° 35. 412N ▲
118° 07. 451W
10:00 [UTC]
Quit>[CLR]
  
```

NOTE

When there is an unread received call, the “*” icon will appear behind the unread category (“DISTRESS” or “DSC CALL”) and station name (or MMSI number).

12.6.3 To Delete the Received Log from the “DSC Log” Directory

- Press the **[CALL MENU]** key. The “DSC MENU” will appear.
- Press the **[▲]** / **[▼]** keys to select “DSC LOG” menu.
- Press the **[ENT]** key, then press the **[▲]** / **[▼]** keys to select “LOG DELETE”.
- Press the **[ENT]** key, then press the **[▲]** / **[▼]** keys to select the category (“DISTRESS” or “DSC CALL”) to be deleted.
- Press the **[ENT]** key, then press the **[▲]** / **[▼]** keys to select the category (DISTRESS or DIST CANCEL: for “DISTRESS”) or station (name or MMSI number: for “DSC CALL”) to be deleted.
- Press and hold the **[ENT]** key until the category or station (name or MMSI number) is removed from the display.
- To exit this menu and return to radio operation mode press the **[CLR]** key.

```

-DSC MENU-
▶INDIVIDUAL
GROUP
ALL SHIPS ▼
Set>[ENT] Quit>[CLR]
  
```

```

-DSC MENU-
POS REQUEST ▲
POS REPORT
▶DSC LOG ▼
Set>[ENT] Quit>[CLR]
  
```

```

-LOG DEL MENU-
▶DISTRESS
DSC CALL
Set>[ENT] Quit>[CLR]
  
```

```

-LOG DEL MENU-
▶DISTRESS ▲
DIST CANCEL
DISTRESS ▼
Set>[ENT] Quit>[CLR]
  
```

12.7 GROUP CALL

This feature allows the user to contact a group of specific vessels (example members of a yacht club) with a Group MMSI number using the Group call function to automatically switch to a desired channel for voice communications. This function is very useful for yacht clubs and vessels traveling together that want to collectively make announcements on a predetermined channel. The **GX1150** can store up to 20 Group call entries.











12.7.1 Setting up a Group Call

For this function to operate the same Group MMSI must be programmed into all the DSC VHF radios within the group of vessels that will be using this feature. To understand about Group MMSI programming, first a Ship MMSI has to be understood.

Ship MMSI: The first three digits called a MID (Mobile Identity Group) of a Ship MMSI denote the country the ship registered for a MMSI. The last 6 digits are specific to the Ships ID. *Ship MMSI Example:* If your MMSI is “366123456”, “366” is MID which denote the country and “123456” is Ships ID for you.

Group MMSI:

- Group MMSI numbers are not assigned by the FCC or other organizations licensed to assign ship MMSI numbers.
- The first digit of a Group MMSI is always set to “0” by International rules. All Standard Horizon radios are preset so when programming a Group MMSI the first digit is set to “0”.
- The USCG recommends programming the MID of a ships MMSI into the Second, Third and Fourth digits of the Group MMSI as it denotes the area the ship is located in.
- The last 5 digits are decided upon by persons in the Group. This is an important step as all radios in the Group must contain the same Group MMSI so they can be contacted by each other. There is a chance that another group of vessels may program in the same Group MMSI. If this happens, simply change one or more of the last 5 digits of the Group MMSI.

1. Press and hold down the  key until “SETUP MENU” menu appears.
2. Press the  /  keys to select “DSC SETUP” menu.
3. Press the  key, then select “GROUP DIR” with the  /  keys.
4. Press the  key, then select “ADD” with the  /  keys.
5. Press the  key.

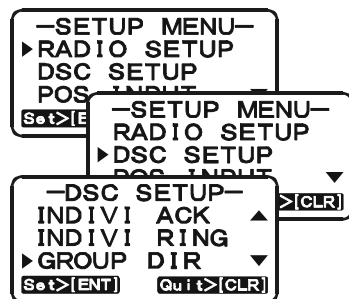

6. Press the / keys to scroll through the first letter of the group name you want to reference in the directory.
7. Press the key to store the first letter in the name and step to the next letter to the right.
8. Repeat step 6 and 7 until the name is complete. The name can consist of up to eleven characters, if you do not use all eleven characters press the key to move to the next space. This method can also be used to enter a blank space in the name. To clear the previous letter, press the key.
9. After the eleventh letter or space has been entered, press and hold the key to advance to the MMSI number (Maritime Mobile Service Identity Number) entry.
10. Press the / keys to scroll through numbers, 0-9. To enter the desired number and move one space to the right press the key. Repeat this procedure until all nine space of the MMSI number are entered.
11. If a mistake was made entering in the name or the MMSI number repeat pressing the microphone's key until the wrong character is selected, then press the or key to enter the correct letter or number.
12. To store the data entered, press and hold the key.
13. To enter another individual address, repeat steps 4 through 12.
14. To exit this menu and return to radio operation mode press the key.



12.7.2 Transmitting a Group Call

Pre-Programmable Calling

1. Press the key. The "DSC MENU" will appear.
2. Press the / keys to select "GROUP". (To cancel, press the key or key.)
3. Press the key. The transceiver will beep, and the "Group Directory" will appear.
4. Press the / keys to select the "Group" you want to contact.
5. Press the key, then press the / keys to select the operating channel you want to communicate on and press the key.

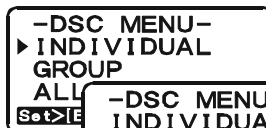

- Press the **[ENT]** key again to transmit the Group Call signal.
- After the GROUP CALL is transmitted, all the radios in the group will switch to the channel which is selected on step 5 above.
- Press the **[CLR]** key to return to radio operation mode.
- Listen to the channel to make sure it is not busy, then key the microphone and call the other vessels you desire to communicate with.

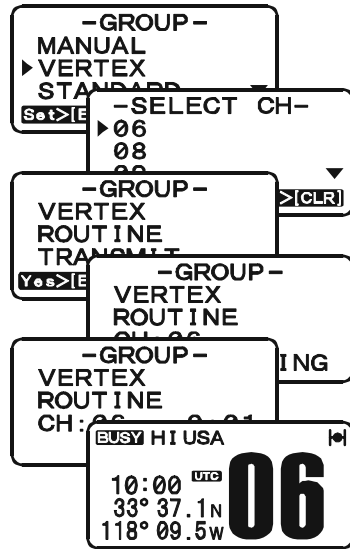

Manual Calling

You may enter an MMSI number manually to contact without the Setting up the Group call number.

- Press the **[CALL MENU]** key. The “DSC MENU” will appear.
- Press the **[▲]** / **[▼]** keys to select “GROUP”. (To cancel, press the **[16/9]** key or **[CLR]** key.)
- Press the **[ENT]** key. The transceiver will beep, and the “Group Directory” will appear.
- Press the **[▲]** / **[▼]** keys to select “MANUAL”, then press the **[ENT]** key.
- Press the **[▲]** / **[▼]** keys to scroll through numbers, 0-9. To enter the desired number and move one space to the right press the **[ENT]** key. Repeat this procedure until all nine space of the MMSI number which you want to contact are entered.
- If a mistake was made entering in the MMSI number, repeat pressing the microphone’s **[H/L]** key until the wrong number is selected, then press the **[▲]** / **[▼]** keys to correct the entry.
- When finish the entering the MMSI number, press and hold the **[ENT]** key.

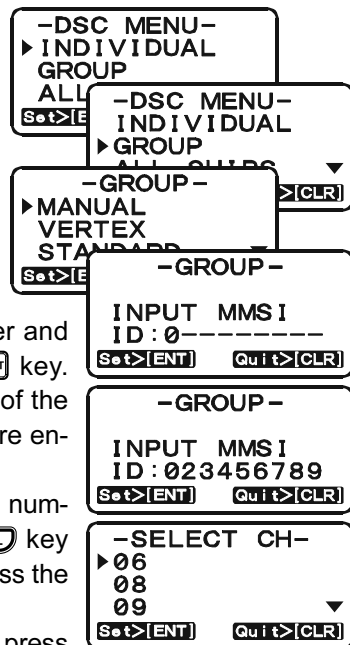

8. Press the **[ENT]** key, then press the **[▲]** / **[▼]** keys to select the operating channel you want to communicate on and press the **[ENT]** key.
9. Press the **[ENT]** key again to transmit the Group Call signal.
10. After the GROUP CALL is transmitted, all the radios in the group will switch to the channel which is selected on step 5 above.
11. Press the **[CLR]** key to return to radio operation mod.
12. Listen to the channel to make sure it is not busy, then key the microphone and call the other vessels you desire to communicate with.

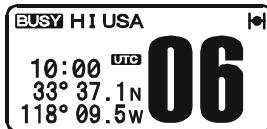
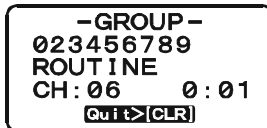
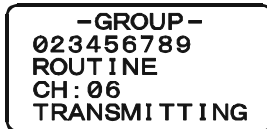

12.7.3 Receiving a Group Call

1. When a group call is received, the **GX1150** will produce a ringing alarm sound.
The display will show the MMSI (or name) of the vessel transmitting the Group Call.
2. Press any key to stop the alarm.
3. To show the nature of the call of the vessel, press the **[▼]** key.
4. If a key is not pressed for thirty seconds after a Group Call is received, the **GX1150** will automatically switch to the requested channel for you to monitor communications.
5. To immediately switch to requested channel, press the **[ENT]** key.
6. If you want the radio to stay on the channel you were on before receiving the Group Call, press the **[CLR]** key.
7. Press the **[CLR]** key to display the operating channel number of the requested channel.
8. Monitor the channel for the person calling the Group for a message.
9. If you want to respond, monitor the channel to make sure it is clear, then press the **PTT** on the mic and talk to the calling ship(s).

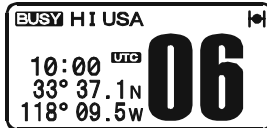
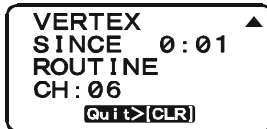
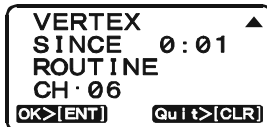
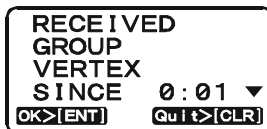

















NOTE

- ❑ When there is an unread Group Call, the “☒” icon will appear on the display. You may review the unread Group Call from the DSC Log, refer to section “12.6.2 Reviewing Received Calls Logged into the Call Waiting Directory.”
- ❑ After a Group call is received, the time the call was made and the ships MMSI or vessels name will appear on the LCD.

12.7.4 Setting up the Group Call Ringer

The **GX1150** has the capability to turn off the Group call ringer.

1. Press and hold down the  key until “SETUP MENU” appears.
2. Press the  /  keys to select “DSC SETUP” menu.
3. Press the  key, then select “DSC BEEP” with the  /  keys.
4. Press the  key.
5. Press the  /  keys to select “GROUP” then press the  key.
6. Press the  /  keys to select “OFF”.
7. Press the  key to store the selected setting.
8. To exit this menu and return to radio operation mode press the  key.

If you wish to return to enabling the ringer tone, just repeat the above procedure, pressing the  /  keys to select “ON” in step 6 above.

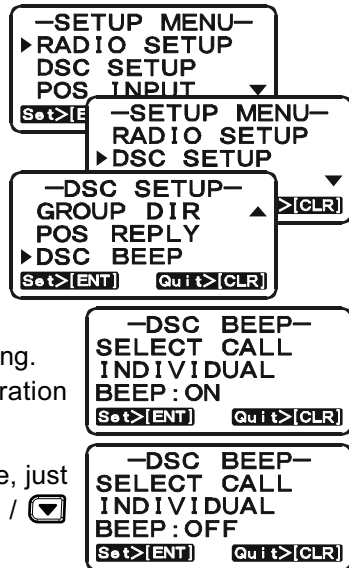

12.8 POSITION REQUEST











Advancements in DSC have made it possible to poll the location of another vessel and show the position of that vessel on the display of the **GX1150**. Standard Horizon has taken this feature one step further, if any Standard Horizon GPS is connected to the **GX1150**, the polled position of the vessel is shown on the display of the GPS chart plotter making it easy to navigate to the location of the polled vessel. This is a great feature for anyone wanting to know the position of another vessel. For example your friend that is catching fish, or finding the location of a person you are cruising with.

NOTE

The other vessel must have an operating GPS receiver connected to its DSC transceiver and must not have its transceiver set to deny position requests. (Refer the section “**12.5.1 Setting up the Individual / Position Call Directory**” to enter information into the individual directory).







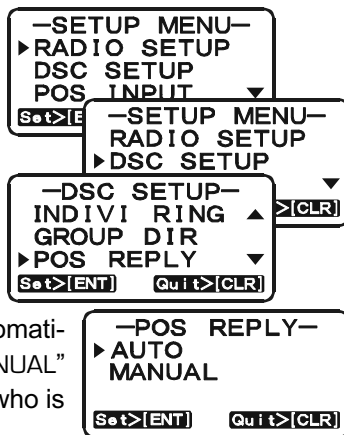







12.8.1 Setting up the Position Reply

The **GX1150** can be set up to automatically or manually send your position to another vessel. This selection is important if you are concerned about someone polling the position of your vessel that you may not want to. In the manual mode you will see the MMSI or persons name shown on the display allowing you to choose to send your position to the requesting vessel.



1. Press and hold down the  key until “SETUP MENU” appear.
2. Press the  /  keys to select “DSC SETUP” menu.
3. Press the  key, then select “POS REPLY” with the  /  keys.
4. Press the  key.
5. Press the  /  keys to select “AUTO” or “MANUAL”. In “AUTO” mode, after a DSC POS Request is received, the radio will automatically transmit your vessels position. In “MANUAL” mode, the display of the **GX1150** will show who is requesting the position.
6. Press the  key to store the selected setting.
7. To exit this menu and return to radio operation mode press the **[16/9]** key.



The **GX1150** has the capability to turn off the Position Request ringer.

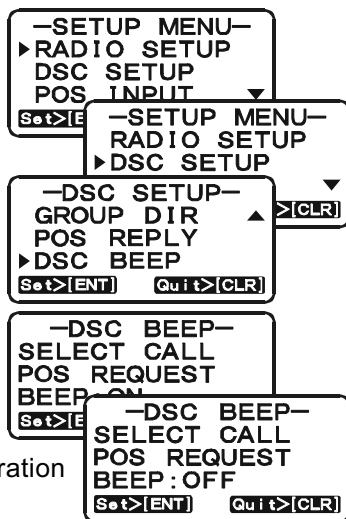







1. Press and hold down the  key until "SETUP MENU" appears.
2. Press the  /  keys to select "DSC SETUP" menu.
3. Press the  key, then select "DSC BEEP" with the  /  keys.
4. Press the  key.
5. Press the  /  keys to select "POS REQUEST".
6. Press the  key.
7. Press the  /  keys to select "OFF".
8. Press the  key to store the selected setting.
9. To exit this menu and return to radio operation mode press the  key.



If you wish to return to enabling the ringer tone, just repeat the above procedure, pressing the  /  keys to select "ON" in step "7" above.

12.8.2 Transmitting a Position Request to Another Vessel

Pre-Programmable Request

1. Press the  key. The "DSC MENU" will appear in the display.
2. Press the  /  keys to select "POS REQUEST".
3. Press the  key to show the Position request directory. This directory uses the INDIVIDUAL Directory information.
4. Press the  /  keys to select a name, then press the  key.
5. Press the  key to transmit the position request DSC call.
6. When the **GX1150** receives the position from the polled vessel, the **GX1150** will produce a ringing alarm sound and the position from the polled vessel is sent to a GPS Chart plotter via NMEA 0183.
7. Press any key to stop the alarm.
8. Press the  key to show the position from the polled vessel transferred on the display.

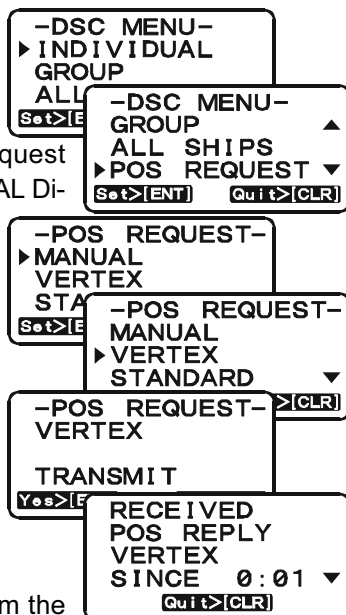

- If the **GX1150** does not receive a reply, the display will be as shown in the illustration on the right. To send again, press the **[ENT]** key.

```

-POS INFO- ▲
33° 35. 412N
118° 07. 451W
10:00 [UTC]
Quit>[CLR]

```

```

-POS REQUEST-
VERTEX
WAIT FOR ACK
SINCE 0:01
Quit>[CLR]

```

NOTE

If the **GX1150** does not receive position data from the polled vessel, the LCD will show “NO POSITION DATA.”

Manual Request

You may enter an MMSI number manually to contact without the Setting up the Individual / Position Call Directory.

- Press the **[CALL MENU]** key. The “DSC MENU” will appear in the display.
- Press the **[▲]** / **[▼]** keys to select “POS REQUEST”.
- Press **[ENT]** key to show the Position request directory. This directory uses the INDIVIDUAL Directory information.
- Press the **[▲]** / **[▼]** keys to select the “MANUAL”, then press the **[ENT]** key.
- Press the **[▲]** / **[▼]** keys to scroll through numbers, 0-9. To enter the desired number and move one space to the right press the **[ENT]** key. Repeat this procedure until all nine space of the MMSI number which you want to contact are entered.
- If a mistake was made entering in the MMSI number repeat pressing the microphone’s **[H/L]** key until the wrong number is selected, then press the **[▲]** / **[▼]** keys to correct the entry.
- When finished entering the MMSI number, press and hold the **[ENT]** key.
- Press the **[ENT]** key to transmit the position request DSC call.
- When the **GX1150** receives the position from the polled vessel, the **GX1150** will produce a ringing alarm sound and the position from the polled vessel is sent to a GPS Chart plotter via NMEA 0183.

```

-DSC MENU-
► INDIVIDUAL
GROUP
ALL SHIPS ▼
Set>[ENT] Quit>[CLR]

```

```

-DSC MENU-
GROUP ▲
ALL SHIPS
► POS REQUEST ▼
Set>[ENT] Quit>[CLR]

```

```

-POS REQUEST-
► MANUAL
VERTEX
STANDARD ▼
Set>[ENT] Quit>[CLR]

```

```

-POS REQUEST-
INPUT MMSI
ID:-----
Set>[ENT] Quit>[CLR]

```

```



-POS REQUEST-
INPUT MMSI
ID:234567891
Set>[ENT] Quit>[CLR]

```

```

-POS REQUEST-
234567891
TRANSMIT
Yes>[ENT] No>[CLR]

```

10. Press any key to stop the alarm.
11. Press the  key to show the position from the polled vessel transferred on the display.
12. If the **GX1150** does not receive a reply, the display will be as shown in the illustration on the right. To send again, press the  key.

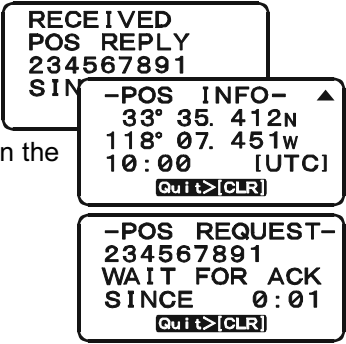

12.8.3 Receiving a Position Request



When a position request call is received from another vessel, a ringing alarm will sound and POS REQUEST will be shown in the LCD. Operation and transceiver function differs depending on “POS REPLY” in the “DSC SETUP” menu setting.

Automatically reply:

1. When a position request call is received, a calling alarm sounds 5 times. After the alarm, the **GX1150** will transmit your position to the vessel who requested it.
2. To exit from position request display, press the  key.



Manually reply:

1. When a position request call is received from another vessel, the **GX1150** will produce a ringing alarm sound and the LCD will be as shown in the illustration at the right.
2. Press any key to stop the alarm.
3. Press the  key to send your position to the requesting vessel, or press the  key.
4. To exit from position request display, press the  key.

















12.9 POSITION REPORT

The feature is similar to Position Request, however instead of requesting a position of another vessel this function allows you to send your position to another vessel. In order to send your position you need to have a GPS receiver connected or to have manually input your position. See section “12.11 MANUAL INPUTTING OF THE GPS LOCATION.”

12.9.1 Setting up a Position Report Ringer

The **GX1150** has the capability to turn off the Position Report ringer.

1. Press and hold down the  key until “SETUP MENU” appears.
2. Press the  /  keys to select “DSC SETUP” menu.
3. Press the  key, then select “DSC BEEP” with the  /  keys.
4. Press the  key.
5. Press the  /  keys to select “POSITION REPORT”.
6. Press the  key.
7. Press the  /  keys to select “OFF”.
8. Press the  key to store the selected setting.
9. To exit this menu and return to radio operation mode press the  key.

To enable the Position Report Ringer, repeat the above procedure, pressing the  /  keys to select “ON” in step “7” above.

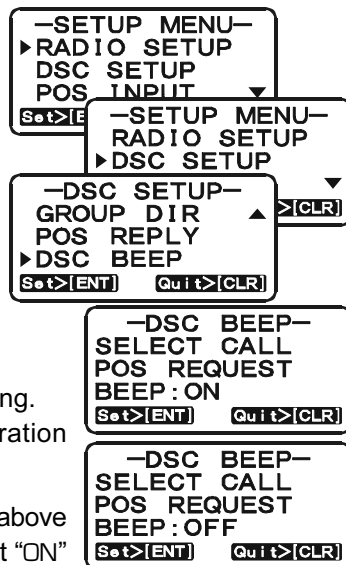

12.9.2 Transmitting a DSC Position Report Call

Pre-Programmable Calling

1. Press the key. The “DSC MENU” will appear in the display.
2. Press the / keys to select the “POS REPORT”.
3. Press the key, then press the / keys to select the category (“ROUTINE” or “SAFETY”) for the Position Report Call.
4. Press the key to show the Position Request Directory. This directory uses the Individual Directory information.
5. Press the / keys to select a “Individual” you want to send your position to, then press the key.
6. Press the key again to send your position to the selected vessel.
7. Press the key to return the display to the radio operation mode display.

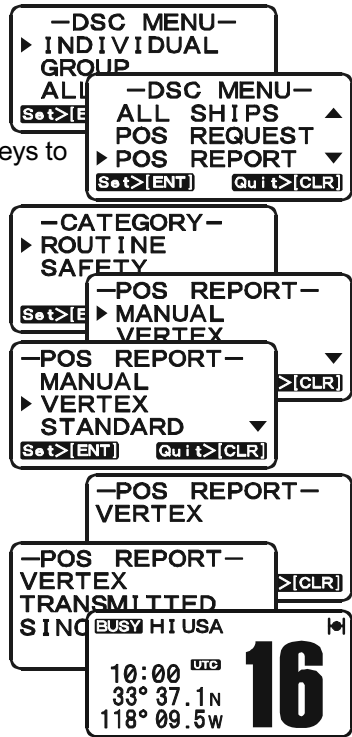





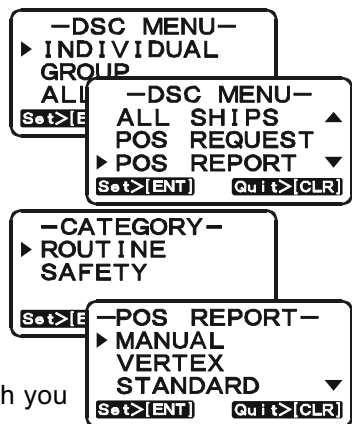

Manual Calling

You may enter an MMSI number manually to call without Setting up the Individual / Position Call Directory.

1. Press the key. The “DSC MENU” will appear in the display.
2. Press the / keys to select the “POS REPORT”.
3. Press the key, then press the / keys to select the category (“ROUTINE” or “SAFETY”) for the Position Report Call.
4. Press key to show the Position Send directory.
5. Press the / keys to select “MANUAL”, then press the key.
6. Enter the MMSI number (nine digits) which you want to contact.



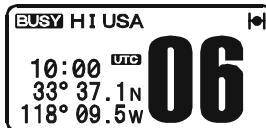
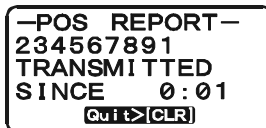
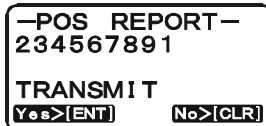
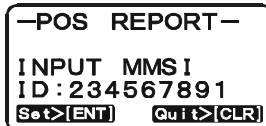
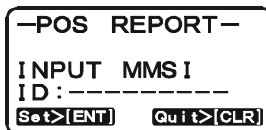

Press the  /  keys to scroll through numbers, 0-9. To enter the desired number and move one space to the right, press the  key. Repeat this procedure until all nine spaces of the MMSI number which you want to contact are entered.

7. If a mistake was made entering in the MMSI number repeat pressing the microphone's  key until the wrong number is selected, then move the channel knob to correct the entry.
8. When finished entering the MMSI number, press and hold the  key.
9. Press the  key to send your position to the selected vessel.
10. Press the  key to return the display to the radio operation mode display.



12.9.3 Receiving a DSC Position Report Call

When another vessel transmits their location to the **GX1150** the following will happen:

1. When the Position Report Call is received, a ringing sound will be produced and the display shows the vessels MMSI or Name, how long since the call was received and the GPS position of the vessel. The **GX1150** will also output NMEA sentences (DSC and DSE) to a connected GPS Chart Plotter.
2. Press any of the keys on the radio to stop the alarm.
3. Press the  /  keys to change the display to view the received data.
4. Press the  key to return the display to the radio operation mode display.

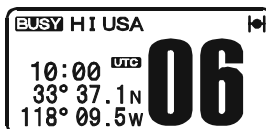
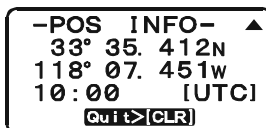

12.10 DSC TRANSMISSION TEST

Use the following procedure to ensure the DSC feature are functioning with another DSC radio.

1. Press the **CALL** key. The “DSC MENU” will appear in the display.
2. Press the **▲** / **▼** keys to select the “DSC TEST”.
3. Press the **ENT** key, then select the station (name or MMSI number) to be sent the test signal with the **▲** / **▼** keys. This directory uses the Individual Directory information.
4. If “Manual” is selected in the previous step, enter the MMSI number (nine digits) which you want to send the test signal to. To do this, press the **▲** / **▼** keys to scroll through numbers “0-9,” then press the **ENT** key to move the entry location to the right. If a mistake was made entering in the MMSI number, repeat pressing the microphone’s **H/L** key until the wrong number is selected, then press the **▲** / **▼** keys to correct the entry. When finished entering the MMSI number, press and hold the **ENT** key.
5. Press the **ENT** key again to transmit the Test signal.
6. After the DSC TEST call is transmitted, the **GX1150** waits for a reply from the radio which was called, the display will show “WAIT FOR ACK”.
7. When an acknowledgement call is received, the **GX1150** will produce a ringing sound and the display will show the bottom display to the right.
8. Press the **CLR** key to return the display to the radio operation mode display.

```

-DSC MENU-
▶ INDIVIDUAL
  GROUP
  ALL SHIPS ▼
So t>[ENT]  Quit t>[CLR]
  
```

```

-DSC MENU-
  POS REPORT ▲
  DSC LOG
  ▶ DSC TEST ▼
So t>[ENT]  Quit t>[CLR]
  
```

```

-TEST-
  MANUAL
  ▶ VERTEX
  STANDARD ▼
So t>[ENT]  Quit t>[CLR]
  
```

```

-TEST-
  VERTEX
  TRANSMIT
Yes>[ENT]  No>[CLR]
  
```

```

-TEST-
  VERTEX
  WAIT FOR ACK
  SINCE 0:01
Quit t>[CLR]
  
```









```

RECEIVED
  TEST ACK
  VERTEX
  SINCE 0:01
Quit t>[CLR]
  
```

12.11 MANUAL INPUTTING OF THE GPS LOCATION (LAT/LON)

You may send the Latitude/Longitude of your vessel manually when a GPS receiver is not connected or is not functioning.

After the position is entered, transmitting a DSC Distress or Position Send will contain the manually entered position.

1. Press and hold down the  key until the "SETUP MENU" appears.
2. Press the  /  keys to select "POS INPUT" menu.
3. Press the  key. The transceiver will beep, and the display will be as shown in the illustration on the right.
4. Enter the time in 24 hour format on the UTC time. Use the  and the microphone's [H/L] key to navigate to each column of the time, then use the  /  keys to select the desired numbers in each column. Repeat for each column, to complete the time.
5. Enter the Latitude/Longitude of your vessel location with the same procedure as description above.
6. To store the data entered, press the  key. To exit this menu and return to radio mode press the  key.



```
---SETUP MENU---
▶RADIO SETUP
DSC SETUP
POS INPUT
```



```
---SETUP MENU---
RADIO SETUP
DSC SETUP
▶POS INPUT
So t>[ENT] Quit>[CLR]
```

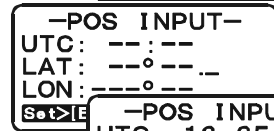

```
---POS INPUT---
UTC:  --:--
LAT:  --°--'
LON:  --°--'
```

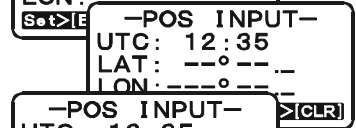

```
---POS INPUT---
UTC: 12:35
LAT:  --°--'
LON:  --°--'
```

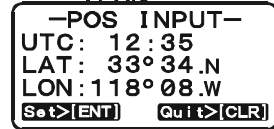

```
---POS INPUT---
UTC: 12:35
LAT: 33°34.N
LON: 118°08.W
So t>[ENT] Quit>[CLR]
```

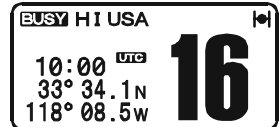









```
BUSY HI USA
10:00 UTC
33° 34.1 N
118° 08.5 W
16
```

13 RADIO SETUP

13.1 LAMP ADJUSTING

Allows adjustment of the backlight intensity or to turn it off.

1. Press and hold down the  key until "SETUP MENU" appears.
2. Press the  key, then select "DIMMER" in the "RADIO SETUP" menu with the  /  keys.
3. Press the  key.
4. Press the  /  keys to select the desired level. When "OFF" is selected, the lamp is extinguished.
5. Press the  key to store the selected level.
6. To exit this menu and return to radio operation mode press the  key.









```
—SETUP MENU—  
▶RADIO SETUP  
DSC SETUP  
POS INPUT ▼  
Set>[ENT] Quit>[CLR]
```

```
—RADIO SETUP—  
▶DIMMER  
CONTRAST  
TIME OFFSET ▼  
Set>[ENT] Quit>[CLR]
```

```
—DIMMER—  
▶HIGH  
6  
5 ▼  
Set>[ENT] Quit>[CLR]
```

13.2 LCD CONTRAST

This selection sets up the display for best viewability for the varying mounting locations (overhead or below).

1. Press and hold down the  key until "SETUP MENU" appears.
2. Press the  key, then select "CONTRAST" in the "RADIO SETUP" menu with the  /  keys.
3. Press the  key.
4. Press the  /  keys to select the desired level. The contrast level can be set from "00" to "24".
5. Press the  key to store the selected level.
6. To exit this menu and return to radio operation mode press the  key.

```
—SETUP MENU—  
▶RADIO SETUP  
DSC SETUP  
POS INPUT ▼  
Set>[ENT] Quit>[CLR]
```

```
—RADIO SETUP—  
DIMMER  
▶CONTRAST  
TIME OFFSET ▼  
Set>[ENT] Quit>[CLR]
```

```
—CONTRAST—  
14 ▲  
13  
▶12 ▼  
Set>[ENT] Quit>[CLR]
```

13.3 TIME OFFSET

This selection sets the time offset between local time and UTC (time GPS sends to radio).

1. Press and hold down the **CALL MENU** key until "SETUP MENU" appears.
2. Press the **ENT** key, then select "TIME OFFSET" in the "RADIO SETUP" menu with the **▲** / **▼** keys.
3. Press the **ENT** key.
4. Press the **▲** / **▼** keys to select time offset from UTC. See illustration below to find your offset time from UTC. If "00:00" is assigned, the time is the same as UTC (Universal Time Coordinated or GMT Greenwich Mean Time).
5. Press the **ENT** key to store the time offset.
6. To exit this menu and return to radio operation mode press the **16/9** key.

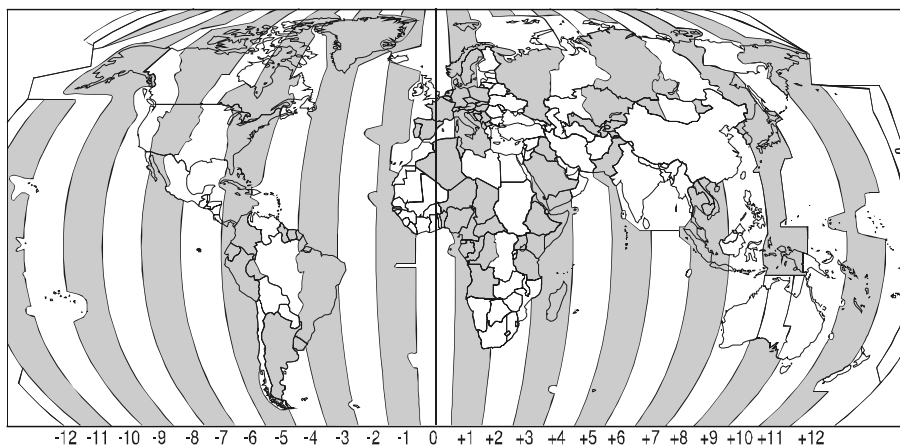
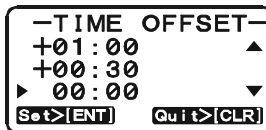

↑
 UTC/GMT
OFFSET TIME TABLE

13.4 TIME DISPLAY

This selection selects the time display between local time and UTC (time GPS sends to radio).

1. Press and hold down the **CALL MENU** key until "SETUP MENU" appears.
2. Press the **ENT** key, then select "TIME DISPLAY" in the "RADIO SETUP" menu with the **▲** / **▼** keys.
3. Press the **ENT** key.
4. Press the **▲** / **▼** keys. to select "UTC" or "LOCAL".
5. Press the **ENT** key to store the selected setting.
6. To exit this menu and return to radio operation mode press the **16/9** key.



In the Local time mode, the display shows the time in 12 hour or when UTC time is selected will show time in 24 hour format.

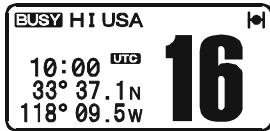

("UTC" mode)

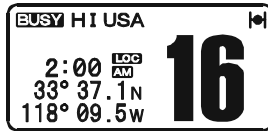

("LOCAL" mode)

13.5 PRIORITY CHANNEL SET









Allows selection of the priority channel.

1. Press and hold down the **CALL MENU** key until "SETUP MENU" appears.
2. Press the **ENT** key, then select "PRIORITY CH" in the "RADIO SETUP" menu with the **▲** / **▼** keys.
3. Press the **ENT** key.
4. Press the **▲** / **▼** keys to select the channel to be a priority.
5. Press the **ENT** key to store the selected setting.
6. To exit this menu and return to radio operation mode press the **16/9** key.



13.6 SCAN TYPE

This selection selects the scan mode between “Memory Scan” and “Priority Scan.”

1. Press and hold down the  key until “SETUP MENU” appears.
2. Press the  key, then select “SCAN TYPE” in the “RADIO SETUP” menu with the  /  keys.
3. Press the  key.
4. Press the  /  keys to select “PRIORITY SCAN” or “MEMORY SCAN”.
5. Press the  key to store the selected setting.
6. To exit this menu and return to radio operation mode press the  key.

```

--SETUP MENU--
▶RADIO SETUP
DSC SETUP
POS INPUT ▼
Set>[ENT] Quit>[CLR]
    
```

```









--RADIO SETUP--
TIME DISPLAY▲
PRIORITY CH
▶SCAN TYPE ▼
Set>[ENT] Quit>[CLR]
    
```

```

--SCAN TYPE--
▶PRIORITY SCAN
MEMORY SCAN
Set>[ENT] Quit>[CLR]
    
```

13.7 KEY BEEP (ON/OFF)

This section allows the level of the key beep to be adjusted or turned off.

1. Press and hold down the  key until “SETUP MENU” appears.
2. Press the  key, then select “KEY BEEP” in the “RADIO SETUP” menu with the  /  keys.
3. Press the  key.
4. Press the  /  keys to select desired beep level.
5. Press the  key to set the key beep condition.
6. To exit this menu and return to radio operation mode press the  key.

```

--SETUP MENU--
▶RADIO SETUP
DSC SETUP
POS INPUT ▼
Set>[ENT] Quit>[CLR]
    
```

```

--RADIO SETUP--
PRIORITY CH ▲
SCAN TYPE
▶KEY BEEP ▼
Set>[ENT] Quit>[CLR]
    
```

```







--KEY BEEP--
LEVEL 5 ▲
LEVEL 4
▶LEVEL 3 ▼
Set>[ENT] Quit>[CLR]
    
```

NOTE

Emergency alarm and beeps for DSC operation cannot be turned OFF.



13.8 WX ALERT

This section allows the NOAA Weather alert to be customized.

1. Press and hold down the  key until "SETUP MENU" appears.
2. Press the  key, then select "WX ALERT" in the "RADIO SETUP" menu with the  /  keys.
3. Press the  key.
4. Press the  /  keys to select the desired Weather Alert mode.



- ON WX CH: Emits a load beep when the Weather Alert is received while receiving the Weather channel.
- ON SCAN: Emits a load beep when the Weather Alert is received while scanning the Weather channels.
- ON WX/SCAN: Emits a load beep when the Weather Alert is received while receiving the Weather channel and/or scanning the Weather channels.
- Off: Disable the Weather Alert function.

5. Press the  key to store the selected setting.
6. To exit this menu and return to radio operation mode press the  key.

14 MAINTENANCE

The inherent quality of the solid-state components used in this transceiver will provide many years of continuous use. Taking the following precautions however, will prevent damage to the transceiver.

- Keep the microphone connected or the jack covered at all times to prevent corrosion of electrical contacts;
- Never key the microphone unless an antenna or suitable dummy load is connected to the transceiver.
- Ensure that the supply voltage to the transceiver does not exceed 16 VDC or fall below 11 VDC.
- Use only STANDARD HORIZON-approved accessories and replacement parts.

In the unlikely event of serious problems, please contact your Dealer or our repair facility.

14.1 REPLACEMENT PARTS

Occasionally an owner needs a replacement mounting bracket or knob. These can be ordered from our Parts Department by writing or calling (in USA or Canada), or Standard Horizon authorized dealers (outside USA or Canada).

Marine Division of YAESU U.S.A.
6125 Phyllis Drive, Cypress, California 90630, U.S.A.
Telephone 800- 767-2450 ext 6800

Commonly requested parts, and their part numbers are listed below.

- **Power Cord:** T9025406
- **VOL/SQL Knob (Black):** RA097700A
- **VOL/SQL Knob (White):** RA097310A
- **Mounting Bracket (Black):** RA0978400
- **Mounting Bracket (White):** RA0978300
- **Mounting Bracket Knob (Black):** RA0978600
- **Mounting Bracket Knob (White):** RA0978500
- **Microphone Hanger (Black):** RA0458800
- **Microphone Hanger (White):** RA0436000

14.2 FACTORY SERVICE

In the unlikely event that the radio fails to perform or needs servicing, please contact STANDARD HORIZON (in USA or Canada) or STANDARD HORIZON authorized dealers (outside USA or Canada).

An “RA” Return Authorisation number is not necessary to send a product in for service. Include a brief note describing the problem along with your name, return address, phone number, and proof of purchase.

14.3 TROUBLESHOOTING CHART

SYMPTOM	PROBABLE CAUSE	REMEDY
Transceiver fails to power up.	No DC voltage to the transceiver, or blown fuse.	a. Check the 12VDC battery connections and the fuse. b. The VOL knob needs to be rotated clockwise to turn the radio on.
Transceiver blows fuse when connected to power supply.	Reversed power wires.	Check the power cable for DC voltage, or replace the fuse (6A 250V). Make sure the red wire is connected to the positive (+) battery post, and the black wire is connected to the negative (-) battery post. If the fuse still blows, contact your Dealer.
Popping or whining noise from the speaker while engine runs.	Engine noise.	Reroute the DC power cables away from the engine. Add noise suppressor on power cable. Change to resistive spark plug wires and/or add an alternator whine filter.
Sound is not emitted from the internal or external speaker.	Accessory cable.	Check the connections of the accessory cable (Possible short circuit on the External speaker cable WHITE/SHIELD).
Receiving station report low transmit power, even with transceiver set to HI power.	Antenna.	Have the antenna checked or test the transceiver with another antenna. If the problem persists, contact your Dealer for servicing.
“HI BATTERY” or “LO BATTERY” message is appeared when the power is turned on.	The power supply voltage is too high or too low.	Confirm that the connected power supply voltage is between 10 volts and 17 volts DC. Confirm that the generator has not malfunctioned.
Your position is not displayed.	Accessory cable.	Check the accessory cable connection. Some GPS use the battery ground line for NMEA connection.
	Setting of the GPS navigation receiver.	Check the output signal format of the GPS navigation receiver. This radio requires NMEA0183 format with GLL, RMC, GGA, or GNS sentence as an output signal. If the GPS has a baud rate setting make sure to select 4800 and parity to NONE.

15 CHANNEL ASSIGNMENTS

Tables on the following columns list the VHF Marine Channel assignments for U.S.A. and International use. Below are listed some data about the charts.

1. VTS. Where indicated, these channels are part of the U.S. Coast Guard's Vessel Traffic System.
2. Alpha channel numbers, that is, channel numbers followed by the letter A (such as Channel 07**A**) are **simplex** channels on the U.S.A. or Canadian channel assignments whose counterparts in the International assignments are **duplex** channels. International channels do not use "alpha" numbers. If you call the Coast Guard on Channel 16, they will sometimes ask you to "**go to channel 22 Alpha.**" This is a channel assigned to U.S.A., and Canadian Coast Guards for handling distress and other calls. If your radio is set for **International** operation you will go to Channel 22 instead of 22**A**, and will not be able to communicate with the Coast Guard. To use Channel 22**A**, your radio must be set for **USA** or **Canada** operation, usually by a U/I/C (USA/International/Canada) control or combination of controls. Channel 22 (without an "A") is an **International** duplex channel for port operations. Some radios indicate an "A" adjacent to the alpha channels on the display; on others "alpha" is not indicated but the proper channel is selected based on the U/I/C setting.
3. Bridge-to-Bridge channels (for example, Channel 13) are for use by bridge operators on inter-coastal waterways and rivers. It is also used by marine vessels in the vicinity of these bridges for navigation and for communicating with the bridge operators. Note that a limit of 1 Watt is specified for these channels.
4. The **S/D** column on the chart indicates either S (simplex) or D (duplex). **Simplex** means transmitting and receiving on the same frequency. Only one party at a time can talk, unlike a telephone. Be sure to say "**over**" and release your microphone push-to-talk switch at the end of each transmission. **Duplex** operation involves the use of one frequency for transmitting and a separate frequency for receiving. On channels specified as duplex on the charts, correct mode of operation is established automatically by your radio when you select a channel; you cannot change the mode. And you still must release the push-to-talk switch after each transmission in order to listen to the radio.
5. Channels normally used by recreational boaters are those that include the term "non-commercial" in the **Channel Use** column of the chart. Some of these are shared with other users and some are used only in certain geographic regions.

6. Marine vessels equipped with VHF radios are required to monitor Channel 16.
7. 156.050 MHz and 156.175 MHz are available for port operations and commercial communications purposes when used only within the U.S. Coast Guard designated Vessel Traffic Services (VTS) area of New Orleans, on the lower Mississippi River from the various pass entrances in the Gulf of Mexico to Devil's Swamp Light at River Mile 242.4 above head of passes near Baton Rouge.
8. 156.250 MHz is available for port operations communications use only within the U.S. Coast Guard designated VTS radio protection areas of New Orleans and Houston described in Sec. 80.383. 156.250 MHz is available for intership port operations communications used only within the area of Los Angeles and Long Beach harbors, within a 25- nautical mile radius of Point Fermin, California.
9. 156.550 MHz, 156.600 MHz and 156.700 MHz are available in the U.S. Coast Guard designated port areas only for VTS communications and in the Great Lakes available primarily for communications relating to the movement of ships in sectors designated by the St. Lawrence Seaway Development Corporation or the U.S. Coast Guard. The use of these frequencies outside VTS and ship movement sector protected areas is permitted provided they cause no interference to VTS and ship movement communications in their respective designated sectors.
10. Use of 156.875 MHz is limited to communications with pilots regarding the movement and docking of ships. Normal output power must not exceed 1 watt. 5: 156.375 MHz and 156.650 MHz are available primarily for intership navigational communications. These frequencies are available between coast and ship on a secondary basis when used on or in the vicinity of locks or drawbridges. Normal output power must not exceed 1 watt. Maximum output power must not exceed 10 watts for coast stations or 25 watts for ship stations.
11. On the Great Lakes, in addition to bridge-to-bridge communications, 156.650 MHz is available for vessel control purposes in established vessel traffic systems. 156.650 MHz is not available for use in the Mississippi River from South Pass Lighted Whistle Buoy "2" and Southwest Pass entrance Mid-channel Lighted Whistle Buoy to mile 242.4 above Head of Passes near Baton Rouge. Additionally it is not available for use in the Mississippi River-Gulf Outlet, the Mississippi River-Gulf Outlet Canal, and the Inner Harbor Navigational Canal, except to aid the transition from these areas.

12. Use of 156.375 MHz is available for navigational communications only in the Mississippi River from South Pass Lighted Whistle Buoy "2" and Southwest Pass entrance Mid channel Lighted Whistle Buoy to mile 242.4 above head of Passes near Baton Rouge, and in addition over the full length of the Mississippi River-Gulf Outlet Canal from entrance to its junction with the Inner Harbor Navigation Canal, and over the full length of the Inner Harbor Navigation Canal from its junction with the Mississippi River to its entry to Lake Pontchartrain at the New Seabrook vehicular bridge.
13. Within 120 km (75 miles) of the United States/Canada border, in the area of the Puget Sound and the Strait of Juan de Fuca and its approaches, 157.425 MHz is half of the duplex pair designated as Channel 88. In this area, Channel 88 is available to ship stations for communications with public coast stations only. More than 120 km (75 miles) from the United States/Canada border in the area of the Puget Sound and the Strait of Juan de Fuca, its approaches, the Great Lakes, and the St. Lawrence Seaway, 157.425 MHz is available for intership and commercial communications. Outside Puget Sound area and its approaches and the Great Lakes, 157.425 MHz is also available for communications between commercial fishing vessels and associated aircraft while engaged in commercial fishing activities.
14. When the frequency 156.850 MHz is authorized, it may be used additionally for search and rescue training exercises conducted by state or local governments.
15. The frequency 156.850 MHz is additionally available to coast stations on the Great Lakes for transmission of scheduled Coded Marine Weather Forecasts (MAFOR), Great Lakes Weather Broadcast (LAWEB) and scheduled Notices to Mariners or Bulletins. F3C and J3C emissions are permitted. Coast Stations on the Great Lakes must cease weather broadcasts which cause interference to stations operating on 156.800 MHz until the interference problem is resolved.
16. The frequency 157.100 MHz is authorized for search and rescue training exercises by state or local government in conjunction with U.S. Coast Guard stations. Prior U.S. Coast Guard approval is required. Use must cease immediately on U.S. Coast Guard request.
17. The duplex pair for channel 20 (157.000/161.600 MHz) may be used for ship to coast station communications.
18. Available for assignment to coast stations, the use of which is in accord with an agreed program, for the broadcast of information to ship stations concerning the enviro.

VHF MARINE CHANNEL CHART							
CH	U	C	I	S/D	TX	RX	CHANNEL USE
01		X	X	D	156.050	160.650	Public Correspondence (Marine Operator)
01A	X			S	156.050		Port Operation and Commercial. VTS in selected areas
02		X	X	D	156.100	160.700	Public Correspondence (Marine Operator)
03		X	X	D	156.150	160.750	Public Correspondence (Marine Operator)
03A	X			S	156.150		U.S. Government Only, Coast Guard
04			X	D	156.200	160.800	Public Correspondence (Marine Operator), Port operation, ship movement
04A		X		S	156.200		Pacific coast: Coast Guard, East Coast: Commercial fishing
05			X	D	156.250	160.850	Public Correspondence (Marine Operator), Port operation, ship movement
05A	X	X		S	156.250		Port operation. VTS in Seattle
06	X	X	X	S	156.300		Inter-ship Safety
07			X	D	156.350	160.950	Public Correspondence (Marine Operator), Port operation, ship movement
07A	X	X		S	156.350		Commercial
08	X	X	X	S	156.400		Commercial (Inter-ship only)
09	X	X	X	S	156.450		Boater Calling channel, Commercial & Non-commercial (Recreational)
10	X	X	X	S	156.500		Commercial
11	X	X	X	S	156.550		Commercial. VTS in selected areas.
12	X	X	X	S	156.600		Port operation. VTS in selected areas.
13	X	X	X	S	156.650		Inter-ship Navigation Safety (Bridge-to-bridge)
14	X	X	X	S	156.700		Port operation. VTS in selected areas.
15	X			S	---	156.750	Environmental (Receive only)
15		X	X	S	156.750		Commercial, non-commercial, ship movement (1 W)
16	X	X	X	S	156.800		International Distress, Safety and Calling
17	X	X	X	S	156.850		State Controlled (1 W)
18			X	D	156.900	161.500	Port operation, ship movement
18A	X	X		S	156.900		Commercial
19			X	D	156.950	161.550	Port operation, ship movement
19A	X			S	156.950		US: Commercial
19A		X		S	156.950		Coast Guard
20	X	X	X	D	157.000	161.600	Canadian Coast Guard Only, International: port operations and shipment
20A	X			S	157.000		Port operation
21			X	D	157.050	161.650	Port operation, ship movement
21A	X	X		S	157.050		U.S. Government Only, Canadian Coast Guard
22			X	D	157.100	161.700	Port operation, ship movement
22A	X	X		S	157.100		US and Canadian Coast Guard Liaison and Maritime Safety Information Broadcasts announced on channel 16
23		X	X	D	157.150	161.750	Public Correspondence (Marine Operator)
23A	X			S	157.150		U.S. Government Only
24	X	X	X	D	157.200	161.800	Public Correspondence (Marine Operator)
25	X	X	X	D	157.250	161.850	Public Correspondence (Marine Operator)
26	X	X	X	D	157.300	161.900	Public Correspondence (Marine Operator)
27	X	X	X	D	157.350	161.950	Public Correspondence (Marine Operator)
28	X	X	X	D	157.400	162.000	Public Correspondence (Marine Operator)

VHF MARINE CHANNEL CHART							
CH	U	C	I	S/D	TX	RX	CHANNEL USE
60		X	X	D	156.025	160.625	Public Correspondence (Marine Operator)
61			X	D	156.075	160.675	Public Correspondence (Marine Operator), Port operation, ship movement
61A	X	X		S	156.075		Public Coast: Coast Guard; East Coast: commercial fishing only
62			X	D	156.125	160.725	Public Correspondence (Marine Operator), Port operation, ship movement
62A		X		S	156.125		Public Coast: Coast Guard; East Coast: commercial fishing only
63			X	D	156.175	160.775	Public Correspondence (Marine Operator), Port operation, ship movement
63A	X	X		S	156.175		Port Operation and Commercial. VTS in selected areas.
64		X	X	D	156.225	160.825	Public Correspondence (Marine Operator), Port operation, ship movement
64A	X	X		S	156.225		Public Correspondence (Marine Operator), Port operation, ship movement
65			X	D	156.275	160.875	Public Correspondence (Marine Operator), Port operation, ship movement
65A	X	X		S	156.275		Port Operations
66			X	D	156.325	160.925	Public Correspondence (Marine Operator), Port operation, ship movement
66A	X	X		S	156.325		Port Operations
67	X	X	X	S	156.375		US: Commercial. Used for Bridge-to-bridge com muni-cations in lower Mississippi River. Inter-ship only, Canada: Commercial fishing, S&R
68	X	X	X	S	156.425		Non-commercial (Recreational)
69	X	X	X	S	156.475		US: Non-commercial (Recreational), Canada: Commercial fishing only, International: Inter-ship, Port operations and Ship movement
70	X	X	X	S	156.525		Digital selective calling (voice communications not allowed)
71	X	X	X	S	156.575		US, Canada: Non-commercial (Recreational), International: Port operations and Ship movement
72	X	X	X	S	156.625		Non-commercial (Inter-ship only)
73	X	X	X	S	156.675		US: Port Operations, Canada: Commercial fish ing only, International: Inter-ship, Port operations and Ship movement
74	X	X	X	S	156.725		US: Port Operations, Canada: Commercial fishing only, International: Inter-ship, Port operations and Ship movement
75	X	X	X	S	156.775		Port Operations (Inter-ship only) (1W)
76	X	X	X	S	156.825		Port Operations (Inter-ship only) (1W)
77	X	X		S	156.875		Port Operations (Inter-ship only) (1W)
77			X	S	156.875		Port Operations (Inter-ship only)
78			X	D	156.925	161.525	Public Correspondence (Marine Operator), Port operation, ship-movement
78A	X	X		S	156.925		Non-commercial (Recreational)
79			X	D	156.975	161.575	Port operation and Ship movement
79A	X	X		S	156.975		Commercial

VHF MARINE CHANNEL CHART							
CH	U	C	I	S/D	TX	RX	CHANNEL USE
80			X	D	157.025	161.625	Port operation, ship movement
80A	X	X		S	157.025		Commercial
81			X	D	157.075	161.675	Port operation, ship movement
81A	X			S	157.075		U.S. Government Only - Environmental protection operations.
81A		X		S	157.075		Canadian Coast Guard Only
82			X	D	157.125	161.725	Public Correspondence (Marine Operator), Port operation, ship movement
82A	X	X		S	157.125		U.S. Government Only, Canadian Coast Guard Only
83		X		D	157.175	161.775	Canadian Coast Guard Only
83			X	D	157.175	161.775	Public Correspondence (Marine Operator)
83A	X	X		S	157.175		U.S. Government Only, Canadian Coast Guard Only
84	X	X	X	D	157.225	161.825	Public Correspondence (Marine Operator)
85	X	X	X	D	157.275	161.875	Public Correspondence (Marine Operator)
86	X	X	X	D	157.325	161.925	Public Correspondence (Marine Operator)
87		X	X	S	157.375		Port operation, ship movement
87A	X			S	157.375		Public Correspondence (Marine Operator)
88		X	X	S	157.425		Port operation, ship movement
88A	X			S	157.425		Commercial, Inter-ship Only
WX01	X	X	X	D	---	162.550	Weather (receive only)
WX02	X	X	X	D	---	162.400	Weather (receive only)
WX03	X	X	X	D	---	162.475	Weather (receive only)
WX04	X	X	X	D	---	162.425	Weather (receive only)
WX05	X	X	X	D	---	162.450	Weather (receive only)
WX06	X	X	X	D	---	162.500	Weather (receive only)
WX07	X	X	X	D	---	162.525	Weather (receive only)
WX08	X	X	X	D	---	161.650	Weather (receive only)
WX09	X	X	X	D	---	161.775	Weather (receive only)
WX10	X	X	X	D	---	163.275	Weather (receive only)

NOTE: Simplex channels, 3A, 21A, 23A, 61A, 64A, 81A, 82A and 83A CANNOT be lawfully used by the general public in U.S.A. waters.

16 WARRANTY

Marine Products Limited Warranty

PLEASE NOTE

The following "Limited Warranty" is for valid for products that have been purchased in the United States and Canada. For limited Warranty details outside the United States, contact the dealer in your country.

STANDARD HORIZON (a division of YAESU U.S.A.) warrants, to the original purchaser only, each new Marine Communications Product ("Product") manufactured and/or supplied by STANDARD HORIZON against defects in materials and workmanship under normal use and service for a period of time from the date of purchase as follows:

Fixed Mount and Portable Transceivers

1 year - if purchased before 01/01/91

3 years - if purchased between 01/01/91 and 01/01/94

3 years Waterproof - if purchased after 01/01/94

Loud hailers

1 year - if purchased before 01/01/91

3 years - if purchased after 01/01/91

Associated Chargers

1 year - if purchased before 01/01/91

3 years - if purchased after 01/01/91

Associated Batteries - 1 year. Note: Batteries will be deemed defective only if storage capacity drops below 80% of rated capacity or if leakage develops.

Associated Accessories - 1 year. Includes: Microphones/Handsets, External Speakers, Antennas, Carrying Accessories, Power Supplies, and Signaling Boards.

To receive warranty service, the purchaser must deliver the Product, transportation and insurance prepaid, to STANDARD HORIZON (a division of YAESU U.S.A.), Attention Marine repairs 6125 Phyllis Drive, Cypress, California 90630. Include proof of purchase indicating model, serial number, and date of purchase. STANDARD HORIZON will return the Product to the purchaser freight prepaid. Products purchased prior to January 1, 1991 will bear the STANDARD HORIZON warranty terms in effect prior to that date.

In the event of a defect, malfunction or failure of the Product during the warranty period, STANDARD HORIZON's liability for any breach of contract or any breach of express or implied warranties in connection with the sale of Products shall be limited solely to repair or replacement, at its option, of the Product or part(s) therein which, upon examination by STANDARD HORIZON,

appear to be defective or not up to factory specifications. STANDARD HORIZON may, at its option, repair or replace parts or subassemblies with new or reconditioned parts and subassemblies. Parts thus repaired or replaced are warranted for the balance of the original applicable warranty.

STANDARD HORIZON will not warrant installation, maintenance or service of the Products. In all instances, STANDARD HORIZON's liability for damages shall not exceed the purchase price of the defective Product.

This warranty only extends to Products sold within the 50 States of the United States of America and the District of Columbia.

STANDARD HORIZON will pay all labor to repair the product and replacement parts charges incurred in providing the warranty service except where purchaser abuse or other qualifying exceptions exist. The purchaser must pay any transportation expenses incurred in returning the Product to STANDARD HORIZON for service.

This limited warranty does not extend to any Product which has been subjected to misuse, neglect, accident, incorrect wiring by anyone other than STANDARD HORIZON, improper installation, or subjected to use in violation of instructions furnished by STANDARD HORIZON, nor does this warranty extend to Products on which the serial number has been removed, defaced, or changed. STANDARD HORIZON cannot be responsible in any way for ancillary equipment not furnished by STANDARD HORIZON which is attached to or used in connection with STANDARD HORIZON's Products, or for the operation of the Product with any ancillary equipment, and all such equipment is expressly excluded from this warranty. STANDARD HORIZON disclaims liability for range, coverage, or operation of the Product and ancillary equipment as a whole under this warranty. STANDARD HORIZON reserves the right to make changes or improvements in Products, during subsequent production, without incurring the obligation to install such changes or improvements on previously manufactured Products.

The implied warranties which the law imposes on the sale of this Product are expressly LIMITED, in duration, to the time period specified above. STANDARD HORIZON shall not be liable under any circumstances for consequential damages resulting from the use and operation of this Product, or from the breach of this LIMITED WARRANTY, any implied warranties, or any contract with STANDARD HORIZON. IN CONNECTION WITH THE SALE OF ITS PRODUCTS, STANDARD HORIZON MAKES NO WARRANTIES, EXPRESS OR IMPLIED AS TO THE MERCHANTABILITY OR FITNESS FOR A PARTICULAR PURPOSE OR OTHERWISE, EXCEPT AS EXPRESSLY SET FORTH HEREIN.

Some states do not allow the exclusion or limitation of incidental or consequential damages, or limitation on how long an implied warranty lasts, so the above limitations or exclusions may not apply. This warranty gives specific legal rights, and there may be other rights which may vary from state to state.

ONLY PRODUCTS SOLD ON OR AFTER JANUARY 1, 1991 ARE COVERED UNDER THE TERMS OF THIS LIMITED WARRANTY.

ON-LINE WARRANTY REGISTRATION

THANK YOU for buying STANDARD HORIZON (a division of YAESU U.S.A.) products! We are confident your new radio will serve your needs for many years!

Please visit **www.standardhorizon.com** to register the **GX1150** Marine VHF. It should be noted that visiting the Web site from time to time may be beneficial to you, as new products are released they will appear on the STANDARD HORIZON Web site. Also a statement regarding product support should be added to the manual.

Product Support Inquiries

If you have any questions or comments regarding the use of the **GX1150**, you can visit the STANDARD HORIZON Web site to send an E-Mail or contact the Product Support team at 800-767-2450 M-F 7:00-5:00PST.

In addition to the warranty, STANDARD HORIZON includes a lifetime "flat rate" and "customer loyalty" programs to provide service after the warranty period has expired. If you wish to obtain the flat rate price for out-of-warranty repair, you must include the information on the Owner's Record with the unit when you return it to your Dealer or to STANDARD HORIZON.

Lifetime Flat Rate Service Program: For the original Owner only, for the lifetime of the unit, STANDARD HORIZON will repair the unit to original specifications.

Note: The flat rate amount is payable by the Owner only if STANDARD HORIZON or the STANDARD HORIZON Dealer determines that a repair is needed. After the repair, a 90-day warranty will be in effect from the date of return of the unit to the Owner.

This service program is not available for equipment which has failed as a result of neglect, accident, breakage, misuse, improper installation or modification, or water damage (depending on the product).

17 SPECIFICATIONS

Performance specifications are nominal, unless otherwise indicated, and are subject to change without notice.

17.1 GENERAL

Channels	All USA, International and Canadian
Input Voltage	13.8 VDC \pm 20%
Current Drain	
Standby	0.3 A
Receive	1.0 A
Transmit	5.5 A (Hi); 1.5 A (Lo)
Individual DSC Directory Memory	48
Group DSC Directory Memory	20
DSC Log Memory (Distress)	20
DSC Log Memory (DSC Call)	38
Dimensions (W x H x D)	6.10" x 2.36" x 6.69" (155 x 60 x 170 mm)
Flush-Mount Dimensions (W x H x D)	5.15" x 2.00" x 6.69" (131 x 51 x 170 mm)
Weight	2.0 lb (920 g)

17.2 TRANSMITTER

Frequency Range	156.025 to 157.425 MHz
RF Output	25 W (Hi); 1 W (Lo)
Conducted Spurious Emissions	80 dB (Hi); 66 dB (Lo)
Audio Response	within +1/-3 of a 6 dB/octave pre-emphasis characteristic at 300 to 3000 Hz
Audio Distortion	5 %
Modulation	16K0G3E, for DSC 16K0G2B
Frequency Stability (-20°C to +50°C)	\pm 1.5 kHz
FM Hum and Noise	50 dB

17.3 RECEIVER

Frequency Range	156.050 to 163.275 MHz
Sensitivity	
12 dB SINAD	0.25 μ V
12 dB SINAD (70 CH Receiver)	0.25 μ V
Squelch Sensitivity (Threshold)	0.20 μ V
Modulation Acceptance Bandwidth	\pm 7.5 kHz
Selectivity	
Spurious and Image Rejection	-75 dB
Intermodulation and Rejection at 12 dB SINAD	-70 dB
Audio Output	4.5 W
Audio Response	within + 1/-3 of a 6 dB/octave de-emphasis characteristic at 300 to 3000 Hz
Frequency Stability (-20°C to +50°C)	\pm 0.0005 %
Channel Spacing	25 kHz
DSC Format	ITU-R M.493
NMEA Input/Output	Output - DSC, DSE Input - GLL, GGA, RMC and GNS

17.4 GX1150 DIMENSIONS

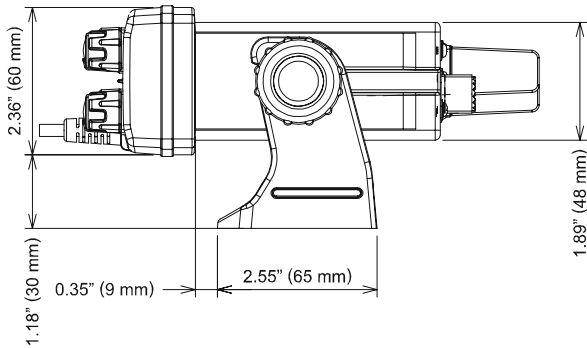
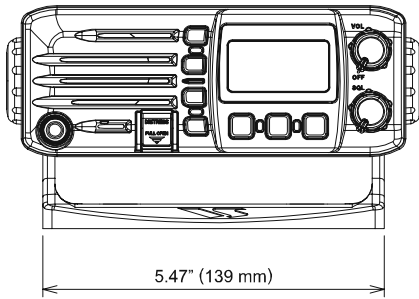
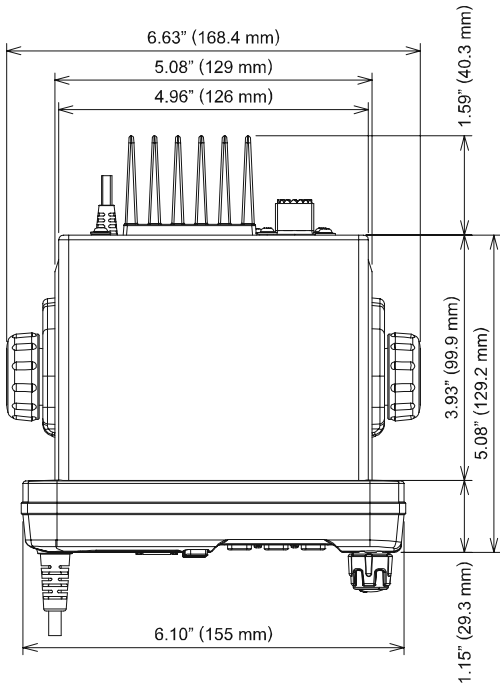

This device complies with part 15 of the FCC rules. Operation is subject to the condition that this device does not cause harmful interference.

Part 15.21: Changes or modifications to this device not expressly approved by YAESU MUSEN could void the User's authorization to operate this device.

STANDARD HORIZON

Nothing takes to water like Standard Horizon

YAESU USA, INC.

6125 Phyllis Drive, Cypress, California 90630, U.S.A.



E M O 3 7 N 1 5 3

Copyright 2012
YAESU MUSEN CO., LTD.
All rights reserved.

No portion of this manual
may be reproduced
without the permission of
YAESU MUSEN CO., LTD.

Printed in China.