

STANDARD HORIZON

Nothing takes to water like Standard Horizon

FF525 BLACK BOX FISH FINDER INSTALLATION MANUAL





FCC Compliance Statement

This device complies with Part 15 of the FCC limits for Class A digital devices. This equipment generates, uses and can radiate radio frequency energy and, if not installed or used in accordance with the instructions may cause harmful interference with radio communications.

There is no guarantee that interference will not occur in a particular instance. If this equipment does cause harmful interference to other equipment, try to correct the problem by relocating the equipment.

Consult an authorized STANDARD HORIZON dealer or other qualified service technician if the problem cannot be corrected. Operation is subject to the following conditions: (1) This device cannot cause harmful interference, and (2) this device must accept any interference received, including interference that may cause undesired operation.

CAUTION

- The FF525 contains dangerous high-voltage circuits which only experienced technicians can handle.
 - STANDARD HORIZON will not be liable for errors contained herein, or for incidental or consequential damages in connection with the performance or use of this material.
 - Because we frequently update our software and applications, the pictures shown through this Owner's Manual may be slightly different from what you see.
-

WARNING

- When plugging in or unplugging a transducer to the FF525 make sure power is turned off.
-

TABLE OF CONTENTS

| | |
|--|-----------|
| 1. INTRODUCTION | 6 |
| 1.0 GENERAL INFORMATION | 6 |
| 1.1 PACKING LIST | 7 |
| 1.1.0 Replacement Parts | 7 |
| 2. MOUNTING THE FF525 | 8 |
| 2.0 INSTALLATION | 8 |
| 2.1 CONNECTIONS | 8 |
| 2.2 POWER CONNECTIONS | 9 |
| 2.3 GPS CHART PLOTTER CONNECTIONS | 9 |
| 2.3.1 Tee Cable | 9 |
| 2.4 OPTIONAL CONNECTIONS | 11 |
| 2.4.0 NMEA Output | 11 |
| 2.4.1 Alarm Buzzer | 11 |
| 2.4.2 Temperature Sensor | 11 |
| 3. TRANSDUCER | 12 |
| 3.0 TRANSDUCER MOUNTING | 12 |
| 3.0.0 Power Boats | 12 |
| 3.0.1 Sailboats | 12 |
| 3.0.2 Transducer Types | 13 |
| 3.0.3 Low Profile Thru-Hull | 13 |
| 3.0.4 Transom (power boats only) | 13 |
| 3.0.5 Fairing Block | 13 |
| 3.0.6 In-hull | 13 |
| 3.0.7 Optional Transducer ID Sensors | 13 |
| 3.0.8 Fish Finder Basics | 14 |
| 4. FF525 SPECIFICATIONS | 15 |
| 5. INSTALLATIONS TIPS | 16 |
| INDEX | 17 |

1. INTRODUCTION

This manual provides installation of the FF525 and associated 600W or 1kW transducers. For operations, refer to the FF525 Operation Manual for CP180/CP180i, CP190i, CP300/CP300i, CPV350, CP390i, CP500, CPV550, CP590 and the FF525 Operation Manual for CPN700i, CPN1010i.

1.0 GENERAL INFORMATION

The FF525 advanced features include:

- 16/256 colors display user selectable
- A-Scope (displays Sonar Echo in real time)
- Preset modes (Fish, Cruise)
- 2x and 4x Zoom (capability to magnify any part of the Fish Finder image of a fixed rate)
- Bottom Lock (capability to magnify a user defined range around the bottom)
- White Line (help distinguish between fish and bottom, when fish are swimming close to the bottom)
- Sensitivity Time Control (STC) reduces Surface Clutter shown on the display by reducing echoes from water disturbances
- Surface Noise Filter (suppresses the displaying of Surface Clutter)
- Interference Rejection (allows reducing interference from other boats/Fish Finders)
- Noise Filter
- Fish Symbol feature
- Transducer ID (automatically selects power output and parameters for best performance).
- Dual Frequency: 50 and 200kHz with the capability to display the two frequencies at the same time.
- Dual Power output: 600/1000W (4800/8000Wpp) depending on the transducer connected. Refer to Par. 3.0.7 "Optional Transducers ID Sensors".
- Max Depth*: 1KW - 1200Ft (365m) at 200kHz, 4000Ft (1219m) at 50kHz
600W - 700Ft (213m) at 200kHz, 1500Ft (457m) at 50kHz
- Min Depth: 2.5Ft (0.8m) at 200kHz, 5Ft (1.6m) at 50kHz
- Max Typical*: 1KW - 980Ft (299m) at 200kHz, 2700Ft (823m) at 50kHz
600W - 600 Ft (183m) at 200kHz, 1350Ft (411m) at 50kHz

*NOTE**

This is not a guaranteed specification. The actual maximum depth capability of the system depends on the type of transducer fitted, the reflectivity of the bottom, water condition, etc.

- Speed through water (if available on transducer)
- Dual temperature inputs Sensor (One channel TEMP1, Optional second channel TEMP2) - if available on transducer
- Trip Log
- External buzzer connections (buzzer not supplied)
- Alarms - Shallow, Depth, Temp Upper and Lower

NOTE

The following STANDARD HORIZON transducers will only operate with the FF525: DST520, DST521, DST523, DST525, DST526, DST527 and DST528A.

Performance of the FF525 used in conjunction with optional transducers (sold separately) will vary based on water conditions, bottom composition, boat hull, vessel speed, installation, and specific transducer model. This includes but is not limited to both minimum and maximum depth performance.

1.1 PACKING LIST

When the package containing the FF525 is first opened, please check for the following contents.

1.1.0 Replacement Parts

| Replacement part | Item |
|-------------------------|--|
| S8101640 | Tee Cable FF525 |
| S8101641 | Power Cable FF525 |
| EM040X104 | FF525 Operation Manual (for CP180/CP180i, CP190i, CP300/CP300i, CPV350, CP390i, CP500, CPV550 and CP590) |
| EM040X152 | FF525 Operation Manual (for CPN700i and CPN1010i) |
| EM040X502 | FF525 Installation Manual |
| XUAIR0029 | DST521 Paddlewheel repair kit |
| XUAIR0030 | DST521 Mounting bracket |
| XUAIR0018 | DST526 Paddlewheel repair kit |

2. MOUNTING THE FF525

The FF525 must be properly installed according the following instructions to get the best possible performance.

NOTE

TRANSDUCER: refer to Chapter 3 and to the Installation Manual supplied with the Transducer.

2.0 INSTALLATION

The FF525 is designed to be mounted horizontally or vertically to enable it to be installed in the most convenient position. After the cables have been run, mount the FF525 in the desired location using the supplied hardware.

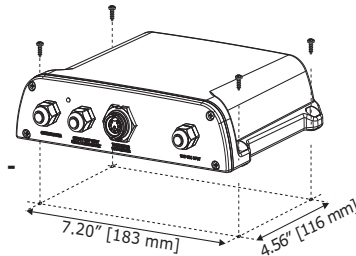

Figure 2.0 - The FF525 Installing

2.1 CONNECTIONS

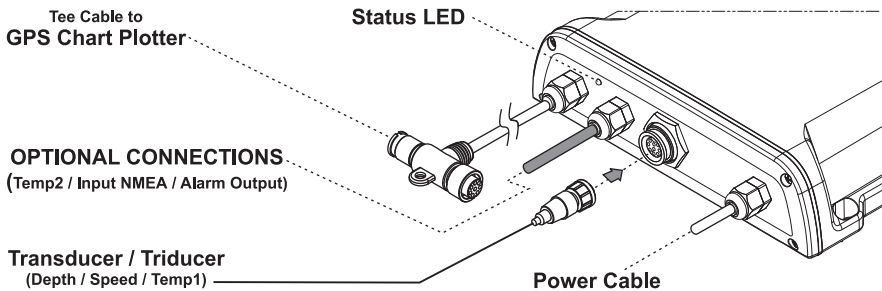

Figure 2.1 - The FF525

2.2 POWER CONNECTIONS

The installation of a switch is necessary to turn On or Off the FF525. STANDARD HORIZON recommends connecting the FF525 and Chart Plotter to the same power switch (not supplied) and fused source as shown in the following images below. Normally spare rocker switch on a dash is used.

2.3 GPS CHART PLOTTER CONNECTIONS

The FF525 is connected to STANDARD HORIZON Chart Plotters via the Tee Cable. Refer to the following images below.

2.3.1 Tee Cable

If the Tee Cable connector is too large to route through your boat, the FF525 can be opened to remove the cable for easier routing. Also if the Tee Cable is not long enough cable can also be added. For some installations, the Tee connector may protrude too far from the rear of the Chart Plotter when the power cable is connected also. If this is the case the Tee connector may be removed. After removal connect each wire of the FF525 and the Chart Plotter via a terminal strip in a dry location or solder and heat shrink wire color to wire color as shown in the table below:

| FF525 | Chart Plotter |
|-------|---------------|
| Gray | Gray |
| White | White |
| Green | Green |

Figure 2.3.1 - FF525 - Chart Plotter table

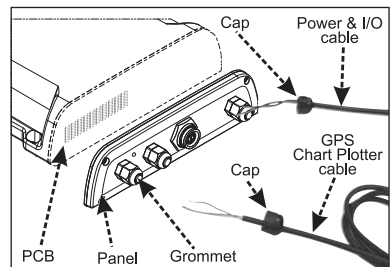
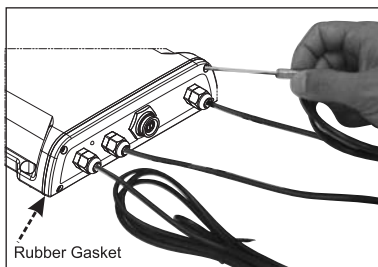

Figure 2.3.1a - Removing Power and Tee cables

WARNING

Before following the steps below, disconnect 12VDC from the FF525.

1. Open the FF525 box by unscrewing the four screws.
2. Once the screws are removed, pull out the panel and the Printed Circuit Board (PCB).
3. Loosen and remove the Green, White and Gray wires from the terminal strip.
4. Then loosen the cap and pull the wires from the inside of the FF525.
5. Route the Tee Cable as need through the vessel and or add additional cable if needed.
6. If the cap was removed, insert it onto the Tee Cable, then insert the cable into the FF525.

7. Reinstall the wires into the terminal strip. From left to right with the wires are Gray, White and Green.
8. Tighten the cap to hold the Tee Cable in place.
9. Push the panel towards the case (be sure to have the rubber gasket positioned correctly).
10. Close the FF525 box by reinstalling the four screws.

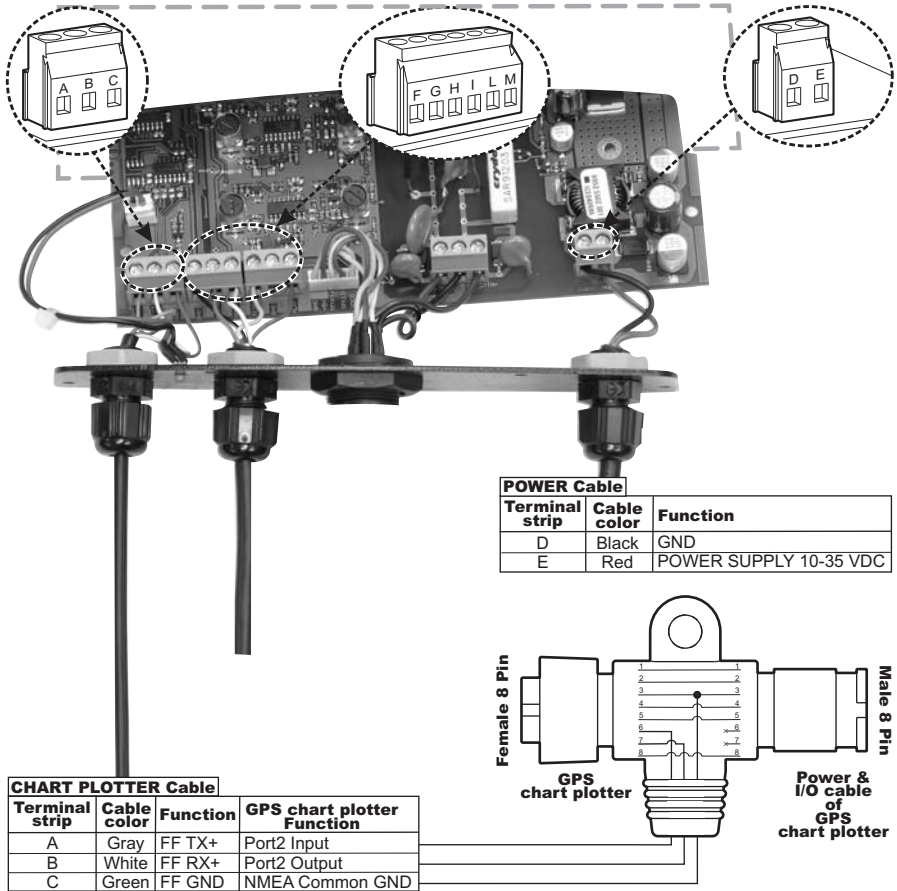

Figure 2.3.1b - Internal connections

IMPORTANT

Refer to software setup section after connections have been made.

2.4 OPTIONAL CONNECTIONS

The FF525 is supplied with connections that allow the FF525 to be connected to the following external devices:

- NMEA device capable of listening to DBT, DPT, VHW, VLW, MTW
- Temperature sensor (10K ohms at 77°F)
- 12VDC Alarm Buzzer (400mA max current draw)



Figure 2.4 - The FF525 Optional Connections

2.4.0 NMEA Output

The following sentences are output: DPT and DBT (Depth), VHW (Speed), VLW (Trip Log), MTW (Water Temperature), XDR (External Temperature Sensor).

2.4.1 Alarm Buzzer

This connection has the capability to drive a buzzer that draws 400mA. Any 12VDC buzzer within the current draw requirements can be connected.

2.4.2 Temperature Sensor

Any thermistor type temp sensor that produces 10K ohms at 77°F can be connected.

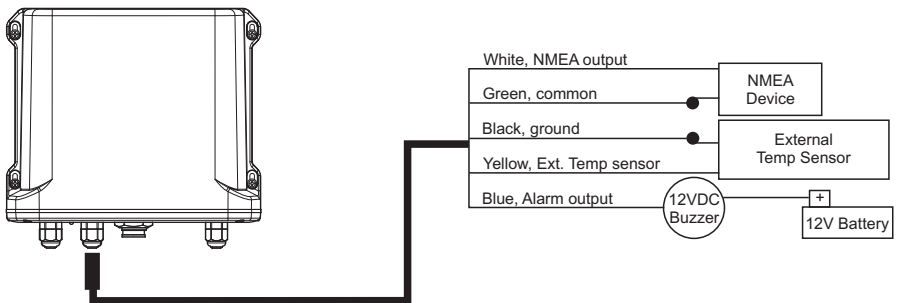

Figure 2.4.2 - Optional Connections

3. TRANSDUCER

WARNING

WHEN PLUGGING IN OR UNPLUGGING A TRANSDUCER TO THE FF525 MAKE SURE POWER IS TURNED OFF.

The transducer is a device that transmits and receives sound waves into the water. The active component inside the transducer is commonly referred to as an element but actually is a piezoelectric ceramic material.

3.0 TRANSDUCER MOUNTING

3.0.0 Power Boats

Basically there are two hull types of powerboats: Planing and Displacement. In the following pictures the boxes with lines are where the transducer should be installed.



Figure 3.0.0 - Planing (on the left) and Displacement (on the right)

The planing hull allows the boat to rise quickly out of the water, allowing the boat to travel at higher speeds.

The displacement hull does not ride up on top of the water; rather it pushes through the water.

3.0.1 Sailboats

Mount the transducer in the first front 1/3 part of the boat, just forward of or the side of the keel.

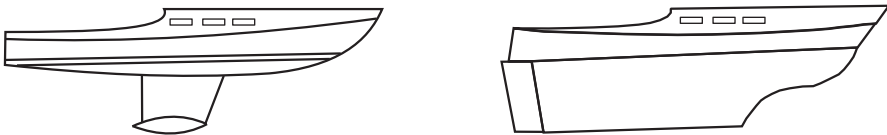

Figure 3.0.1 - Fin Keel (on the left) and Full Keel (on the right)

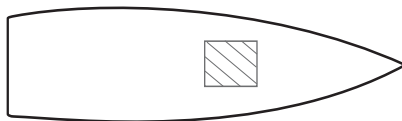

Figure 3.0.1a - Mounting Area

3.0.2 Transducer Types

Since there are many different shapes and sizes of hulls, STANDARD HORIZON offers a range of Depth transducers to fit the vessels requirements.

3.0.3 Low Profile Thru-Hull

If the user is planning to mount a thru-hull transducer first he has to know the dead rise angle where the transducer will be located on the boat. The "Dead Rise" is a nautical term that refers to the angle of the hull where the transducer will be mounted (see picture below). Specific transducers are designed to be installed on boats with different dead rises.

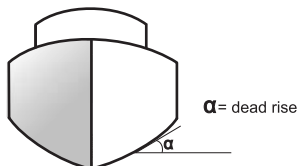

Figure 3.0.3 - Dead rise

3.0.4 Transom (POWER BOATS ONLY)

The back of a boat is called the transom this is where this transducer is mounted. This transducer has a bracket that is screwed down onto the hull.

3.0.5 Fairing Block

Used when a hull is over 10-15 degrees.

- The Fairing Block is used to compensate the dead rise of the hull. The Fairing Block STANDARD HORIZON offers is made from hard plastic which fits around the transducer.
- To install the transducer and Fairing Block, the user measures the dead rise of the hull and cuts the Fairing Block to that angle. One half of the Fairing Block mounts on the inside while the other part of the Fairing Block mounts on the outside of the hull.

3.0.6 In-hull

This transducer is epoxyed to the inside of the hull that is not more than 1/2 inch thick and is solid not cored.

3.0.7 Optional Transducer ID Sensors







| | | | | | | |
|---|---|---|---|---|---|--|
|  |  |  |  |  |  |  |
| DST520 2" Nylon Thru-hull Depth & Temp | DST521 Transom Mount, Depth, Speed & Temp | DST523 2" Bronze Thru-hull Depth & Temp | DST525 In-Hull Mount, Depth | DST526 Bronze Thru-hull, Triducer, Depth, Speed & Temp, with fairing block | DST527 In-Hull Mount, Depth | DST528A Thru-hull, Long stem, Depth & Temp, with fairing block |
| 600W Transducers | | | | | 1000W Transducers | |

Figure 3.0.7 - Optional Transducers

3.0.8 Fish Finder Basics

The FF525 consists of a high power transmitter, sensitive receiver and a transducer. The FF525 sends an electrical pulse to the transducer, which contains an element that converts the pulse into acoustic (sound) waves, which is sent through the water. As this wave travels from the transducer to the bottom, it may strike fish, structures, thermoclines (temperature changes in the water). When the wave strikes an object(s) a certain amount of the wave is reflected back to the transducer depending on the composition and shape of the object. When the reflected wave is returned to the transducer it is converted into a voltage and is amplified by the receiver, processed and sent to the display. The speed of sound in water is roughly 4800 Ft/sec, so the time lapse between the transmitted signal and the received echo can be measured and the distance to the object determined.

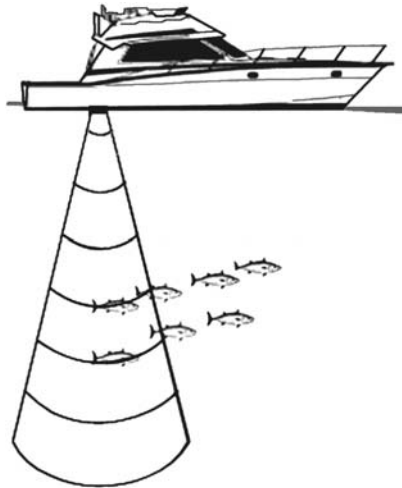

Figure 3.0.8 - Fish Finder working principle

4. FF525 SPECIFICATIONS

| | |
|------------------------------------|---|
| Power supply | : 10 - 35 Volt dc |
| Max stand by current draw | : 1KW:142mA at 12 Volt dc : 600W:100mA at 12 Volt dc |
| Max current draw | : 1KW:1.42A at 12 Volt dc : 600W:1A at 12 Volt dc |
| Power Output | : 600/1000W (4800/8000W Peak to Peak) |
| Display Colors | : 16/256 colors user selectable |
| Display Vertical Resolution | : 400 pixels ON CPV350/CP300/CP300i/CP390i/CPV550/CP500 /CP590/CPN700i/CPN1010i : 200 pixels ON CP180/CP180i/CP190i |
| Frequency | : Dual 50 and 200kHz |
| Max Depth* | : 1KW:1200Ft(365m) at 200kHz; 4000Ft(1219m) at 50kHz : 600W:700Ft (213m) at 200kHz; 1500Ft (457m) at 50kHz |
| Min Depth | : 2.5Ft (0.8m) at 200kHz; 5Ft (1.6m) at 50kHz |
| Max Typical* | : 1KW:980Ft (299m) at 200kHz; 2700Ft (823m) at 50kHz : 600W:600 Ft (183m) at 200kHz; 1350Ft (411m) at 50kHz |

*NOTE**

This is not a guaranteed specification. The actual maximum depth capability of the system depends on the type of transducer fitted, the reflectivity of the bottom, water condition, etc.

| | |
|------------------------------------|---|
| NMEA Output sentences | : Depth: DBT, DPT Temperature: MTW Speed (with DST526): VHW |
| Weight | : 2.20 LBS (1 kg) |
| Operating temperature range | : 32°F to 122°F (0°C to +50°C) |
| Storage temperature range | : -4°F to 158°F (-20°C to +70°C) |

Dimensions - inch (mm) :

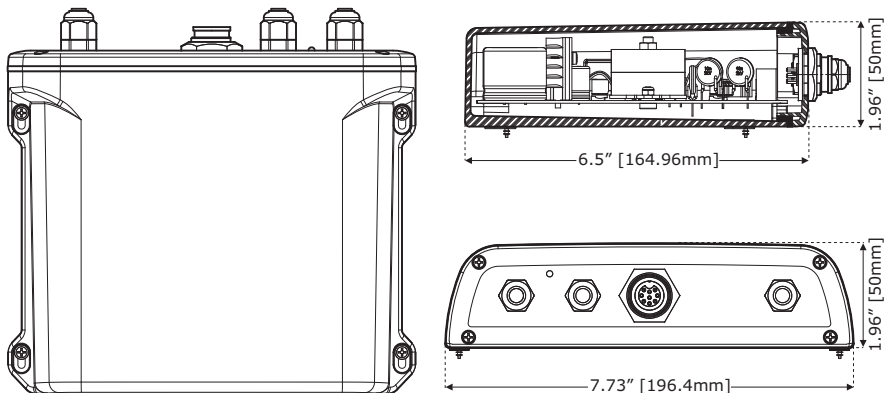

Figure 4 - FF525 Dimensions [inch/mm]

5. INSTALLATIONS TIPS

5.0 *How can I disconnect the cables from the FF525 in case I need to do so for the installation?*

- Open the FF525 box by unscrewing the four screws (see Figure on Par. 2.3.1).
- Once the screws are removed, pull out the panel and the Printed Circuit Board (PCB). Unscrew the cables from the PCB.
- Wire the cables as needed.
- Reconnect the cables to the PCB.
- Push the panel towards the case (be sure to have well positioned the rubber gasket). Close the FF525 box by screwing the four screws.

5.1 *LED Status Indicator*

The FF525 has a small LED that blinks. There are seven different LED behaviours, representing seven different diagnostic conditions described below.

- OFF : DC power is not being supplied to the FF525.
- ON CONTINUOUSLY : The transducer is not connected to the Chart Plotter and problem with cable of the transducer cable.
- 1 LONG FLASH EVERY 2 SECONDS : The FF525 is not connected with the Chart Plotter. Black Box is working properly, but it is not connected to the Chart Plotter. Configure the I/O Port.
- 2 SHORT FLASHES EVERY 2 SECONDS : The FF525 is connected to the Chart Plotter and is operating correctly.
- 3 SHORT FLASHES EVERY 2 SECONDS : A not-STANDARD HORIZON transducer (without transducer ID) has been connected
- 4 SHORT FLASHES EVERY 2 SECONDS : No transducer connected.

INDEX

| | | | |
|-----------------------------------|-----------|------------------------------|--------|
| 16/256 colors | 6, 15 | FCC | 4 |
| A | | features | 6 |
| A-Scope | 6 | Fin Keel | 12 |
| Alarm Buzzer | 11 | Fish | 6 |
| Alarms | 6 | fish | 14 |
| | | Fish Finder | 14 |
| B | | Fish Symbol | 6 |
| Black Box | 16 | Frequency | 15 |
| Bottom Lock | 6 | Full Keel | 12 |
| buzzer | 6, 11 | | |
| | | I | |
| C | | In-hull | 13 |
| Compliance Statement | 4 | INSTALLATION | 8 |
| CONNECTIONS | 8 | installation | 16 |
| CP180 | 6, 15 | Interference Rejection | 6 |
| CP180i | 6, 15 | Internal connections | 10 |
| CP190i | 6, 15 | | |
| CP300 | 6, 15 | K | |
| CP300i | 6, 15 | keel | 12 |
| CP390i | 6, 15 | | |
| CP500 | 6, 15 | L | |
| CP590 | 6, 15 | LED Status | 16 |
| CPN1010i | 6, 15 | Low Profile Thru-Hull | 13 |
| CPN700i | 6, 15 | | |
| CPV350 | 6, 15 | M | |
| CPV550 | 6, 15 | Max current draw | 15 |
| Cruise | 6 | Max Depth | 6, 15 |
| | | Max Typical | 6, 15 |
| D | | Min Depth | 6, 15 |
| DBT | 11, 15 | MOUNTING | 12 |
| DC power | 16 | Mounting Area | 12 |
| dead rise | 13 | Mounting bracket | 7 |
| Depth | 6, 11, 15 | MOUNTING THE FF525 | 8 |
| Dimensions | 15 | MTW | 11, 15 |
| Displacement | 12 | | |
| Display Colors | 15 | N | |
| DPT | 11, 15 | NMEA device | 11 |
| DST520 | 6 | NMEA Output | 11, 15 |
| DST521 | 6 | Noise Filter | 6 |
| DST523 | 6 | | |
| DST525 | 6 | O | |
| DST526 | 6, 15 | Operating temperature | 15 |
| DST527 | 6 | Operation Manual | 6 |
| DST528A | 6 | OPTIONAL CONNECTIONS | 11 |
| Dual Frequency | 6 | Optional Transducer | 13 |
| Dual Power output | 6 | | |
| | | P | |
| E | | package | 7 |
| External buzzer | 6 | PACKING LIST | 7 |
| external devices | 11 | Paddlewheel repair kit | 7 |
| External Temperature Sensor | 11 | PCB | 9, 16 |
| | | Planing | 12 |
| F | | Power Boats | 12 |
| Fairing Block | 13 | Power Cable | 7 |
| | | POWER CONNECTIONS | 9 |

| | |
|-----------------------------|-------|
| Power Output | 15 |
| Power supply | 15 |
| power switch | 9 |
| Preset modes | 6 |
| Printed Circuit Board | 9, 16 |

R

| | |
|-------------------------|----|
| receiver | 14 |
| Replacement Parts | 7 |
| Resolution | 15 |

S

| | |
|--------------------------------|--------|
| Sailboats | 12 |
| Sensitivity Time Control | 6 |
| Sonar Echo | 6 |
| sound wave | 12 |
| SPECIFICATIONS | 15 |
| Speed | 11, 15 |
| speed | 14 |
| Speed through water | 6 |
| STC | 6 |
| Storage temperature | 15 |
| Surface Clutter | 6 |
| Surface Noise Filter | 6 |
| switch | 9 |

T

| | |
|---------------------|----------|
| Tee Cable | 7, 9, 10 |
| Tee connector | 9 |
| Temperature | 15 |

| | |
|---------------------------------|--------|
| temperature inputs Sensor | 6 |
| Temperature Sensor | 11 |
| thermocline | 14 |
| thru-hull transducer | 13 |
| TRANSDUCER | 12 |
| transducer | 14, 16 |
| Transducer ID | 6 |
| TRANSDUCER MOUNTING | 12 |
| Transducer Types | 13 |
| transmitter | 14 |
| Transom | 13 |
| Trip Log | 6, 11 |

V

| | |
|---------------|--------|
| VHW | 11, 15 |
| VLW | 11 |
| voltage | 14 |

W

| | |
|-------------------------|----|
| Water Temperature | 11 |
| wave | 14 |
| Weight | 15 |
| White Line | 6 |
| working principle | 14 |

X

| | |
|-----------|----|
| XDR | 11 |
|-----------|----|

Z

| | |
|------------|---|
| Zoom | 6 |
|------------|---|

PLEASE NOTE

United States: To receive warranty service, the purchaser must deliver the Product, transportation and Insurance prepaid, to STANDARD HORIZON (Marine Division of YAESU USA) - Attention Factory Service - 6125 Phyllis Drive - Cypress, CA 90630, include proof of purchase indicating model, serial number and date of purchase. This warranty only extends to Products sold within the 50 States of the United States of America and the District of Columbia.

Europe: Contact details for warranty in Europe are available from the dealer in your country or from www.standardhorizon.co.uk where details of warranty terms and contact details for Europe can be obtained.

For Limited Warranty details outside United States and Europe, contact the dealer in your country.

STANDARD HORIZON LIMITED WARRANTY

STANDARD HORIZON (the Marine Division of YAESU USA) warrants, to the original purchaser only, each new Marine Product ("Product") manufactured and/or supplied by STANDARD HORIZON against defects in materials and workmanship under normal use and service for a period of 3 years from the date of purchase.

In the event of a defect, malfunction or failure of the Product during the warranty period, STANDARD HORIZON's liability for any breach of contract or any breach of express or implied warranties in connection with the sale of Products shall be limited solely to repair or replacement, at its option, of the Product or part(s) therein which, upon examination by STANDARD HORIZON, appear to be defective or not up to factory specifications. STANDARD HORIZON may, at its option, repair or replace parts or subassemblies with new or reconditioned parts and subassemblies.

STANDARD HORIZON will not warrant installation, maintenance or service of the Products. In all instances, STANDARD HORIZON's liability for damages shall not exceed the purchase price of the defective Product.

STANDARD HORIZON will pay all labor and replacement parts charges incurred in providing the warranty repair service except where purchaser abuse or other qualifying exceptions exist. The purchaser must pay any transportation expenses incurred in returning the Product to STANDARD HORIZON for service.

This limited warranty does not extend to any Product which has been subjected to misuse, neglect, accident, incorrect wiring by anyone other than STANDARD HORIZON, improper installation, or subjected to use in violation of instructions furnished by STANDARD HORIZON, nor does this warranty extend to Products on which the serial number has been removed, defaced, or changed. STANDARD HORIZON cannot be responsible in any way for ancillary equipment not furnished by STANDARD HORIZON which is attached to or used in connection with Products, or for the operation of the Product with any ancillary equipment, and all such equipment is expressly excluded from this warranty. STANDARD HORIZON disclaims liability for range, coverage, or operation of the Product and ancillary equipment as a whole under this warranty.

STANDARD HORIZON reserves the right to make changes or improvements in Products, during subsequent production, without incurring the obligation to install such changes or improvements on previously manufactured Products. The implied warranties which the law imposes on the sale of this Product are expressly LIMITED, in duration, to the time period specified above. STANDARD HORIZON shall not be liable under any circumstances for consequential damages resulting from the use and operation of this Product, or from the breach of this LIMITED WARRANTY, any implied warranties, or any contract with STANDARD HORIZON. IN CONNECTION WITH THE SALE OF ITS PRODUCTS, STANDARD HORIZON MAKES NO WARRANTIES, EXPRESS OR IMPLIED AS TO THE MERCHANTABILITY OR FITNESS FOR A PARTICULAR PURPOSE OR OTHERWISE, EXCEPT AS EXPRESSLY SET FORTH HEREIN.

Some Countries in Europe and States of the USA do not allow the exclusion or limitation of incidental or consequential damages, or limitation on how an implied warranty lasts, so the above limitation or exclusions may not apply. This warranty provides specific rights, there may be other rights available which may vary between countries in Europe or from state to state within the USA.

YAESU

STANDARD HORIZON

Yaesu UK Ltd
Unit 12, Sun Valley Business Park
Winnall Close
Winchester SO23 0LB
United Kingdom
Tel: +44 (0)1962 866667
Fax: +44 (0)1962 856801
Email: sales@yaesu.co.uk

Declaration of Conformity

Nr. YUK-DOC-1214-11

We, Yaesu UK Ltd. certify and declare under our sole responsibility that the following equipment complies with the essential requirements of the Directive 1999/5/EC, with the provisions of Annex III (Conformity Assessment procedure referred to in article 10)

| | |
|--------------------------|-------------------------------------|
| Type of Equipment: | Fishfinder |
| Brand Name: | Standard Horizon |
| Model Number | FF525 |
| Manufacturer | TWS S.r.l |
| Address of Manufacturer: | Via Zaccagna 6, 54033 Carrara Italy |

Applicable Standards:

This equipment is tested to and conforms to the essential requirements of directive, as included in following standards:

| Test | Standard |
|---|-----------------------------------|
| Conducted Emissions Radiated Emissions Radiated interference | IEC EN 60945:2003/11 |
| Electrostatic Discharge ESD Conducted RF interference Conducted RF immunity | IEC EN 60945:2003/11 |
| Compass Safe Distance | IEC EN 60945:2003/11 ISO/R 694 |
| EFT – Bursts Fast Transients | IEC EN 60945:2003/11 |
| DC Power Interruptions, Variation and Polarity inversions | IEC EN 60945:2003/11 |
| Safety: Part 1 General Requirements | IEC EN 60950-1:2006/A1:2010 |

The technical documentation as required by the Conformity Assessment procedures is kept at the following address:

Company: Yaesu UK Ltd
Address: Unit 12, Sun Valley Business Park,
Winnall Close, Winchester SO23 0LB

Technical Construction File: Issued by Yaesu Musen Co., Ltd., Tokyo, Japan
File No: UK001214

Drawn up in:

Date:

Winchester, United Kingdom

26th January 2012



Name and position:

PCJ Bigwood,
Technical Sales Manager