

 **STANDARD HORIZON**

**GPS Chart Plotters**

**CP590**

**12" WAAS GPS Chart Plotter**

**Owner's Manual**



---

### **WARNING!!!**

Electronic charts displayed by the GPS Chart Plotter are believed to be accurate and reliable, but are not intended to be a substitute for the official charts, which should remain your main reference for all matters related to the execution of safe navigation. For this reason you should always keep the official published and approved nautical charts on board.

---

### **CAUTION**

- The GPS Chart Plotter is designed for maritime use. To avoid water intrusion, ensure the C-MAP BY JEPPESEN C-CARD door is completely closed.
  - Extensive exposure to heat may result in damage to the GPS Chart Plotter.
  - The GPS Chart Plotter contains dangerous high-voltage circuits which only experienced technicians can handle.
  - STANDARD HORIZON will not be liable for errors contained herein, or for incidental or consequential damages in connection with the performance or use of this material.
- 



### **FCC Compliance Statement**

*This device complies with Part 15 of the FCC limits for Class A digital devices. This equipment generates, uses and can radiate radio frequency energy and, if not installed or used in accordance with the instructions may cause harmful interference with radio communications.*

*There is no guarantee that interference will not occur in a particular instance. If this equipment does cause harmful interference to other equipment, try to correct the problem by relocating the equipment.*

*Consult an authorized STANDARD HORIZON dealer or other qualified service technician if the problem cannot be corrected. Operation is subject to the following conditions: (1) This device cannot cause harmful interference, and (2) this device must accept any interference received, including interference that may cause undesired operation.*

---

### **CLEANING PROCEDURE FOR THE GPS CHART PLOTTER SCREEN**

Cleaning of the chart plotter screen is a very important operation and must be done carefully. Since the surface is covered by a antireflective coating, the procedure for cleaning all the surfaces can be performed using the following procedure: Use a clean, soft, lint-free cloth to clean the glass. We recommend using a micro-fiber cloth. Spray a small amount of ammonia-free cleaner (isopropyl alcohol) onto the cloth. Spraying on the cloth will prevent overspray. Fold the cloth or lens cloth into a triangular shape, moisten the tip and use the index finger behind a corner to move the cloth across the surface in overlapping side to side strokes. If the cloth is too wet, a noticeable wet film will be left in its path and you will need to repeat the process. If too dry, the cloth won't glide easily, and may damage the surface.

---

---

# TABLE OF CONTENTS

---

<b>1. INTRODUCTION .....</b>	<b>9</b>
1.0 GENERAL INFORMATION .....	9
1.1 PACKING LIST .....	10
1.2 OPTIONAL ACCESSORIES .....	10
1.3 RADAR UNIT SUPPLIED BY SI-TEX USA .....	10
<b>2. GETTING STARTED .....</b>	<b>11</b>
2.0 MOUNTING THE GPS CHART PLOTTER .....	11
2.1 BRACKET MOUNTING .....	11
2.3 EXTERNAL GPS ANTENNA MOUNTING .....	12
2.3.0 Flush mounting the antenna .....	12
2.3.1 GPS cable .....	13
2.3.2 GPS Antenna connections .....	13
2.4 PWR Cable .....	13
2.4.0 Battery Connections .....	13
2.4.1 NMEA Connections .....	14
2.4.2 ACC 2 Connector .....	16
<b>3. CONTROLS AND INDICATORS .....</b>	<b>19</b>
3.0 CONTROLS AND CONNECTIONS .....	19
3.0.1 The alphanumeric keys .....	21
3.1 GETTING STARTED .....	21
3.1.0 Power On, Off and ShuttlePoint Knob operation .....	21
3.1.1 Cursor Vs. Home Mode .....	22
3.1.2 Cursor and Menu selection speed .....	23
3.1.3 Changing the Ship Icon .....	23
3.1.4 Changing the backlight and contrast .....	24
3.1.5 Selecting North Up or Course Up .....	24
3.2 AUTOMATIC TIME .....	25
3.3 SELECTING LORAN TD OR OTHER COORDINATE SYSTEM .....	26
3.4 CHANGING THE CHART COLOR .....	27
3.5 SELECTING LANGUAGE .....	27
3.6 SELECTING PAGES WITH SOFT KEYS .....	28
3.7 CUSTOMIZING THE SOFT KEYS .....	29
3.8 SETTINGS IN GENERAL SETUP MENU .....	29
3.9 ABOUT PAGE .....	31
<b>4. FIND SERVICES .....</b>	<b>32</b>
4.0 USING FIND SERVICES & MORE FUNCTIONS .....	32
4.0.0 Port Services .....	32
4.0.1 Port .....	33
4.0.2 Tide Stations .....	33
4.0.3 Wrecks .....	34
4.0.4 Obstructions .....	35
4.0.5 Lakes Information .....	35
4.0.6 Lakes By Name .....	37
4.0.7 Points Of Interest .....	38
4.0.8 User Points .....	38

4.0.9	Coordinates .....	39
4.0.10	Information .....	39
<b>5.</b>	<b>MAX CARTOGRAPHY OVERVIEW .....</b>	<b>41</b>
5.0	BUILT-IN CHARTS .....	41
5.0.0	Coverage areas and details .....	41
5.0.1	Updating Built-In Charts .....	41
5.1	INSERTING THE OPTIONAL MAX C-CARD .....	42
<b>6.</b>	<b>CHART FUNCTIONS .....</b>	<b>44</b>
6.0	MAX FUNCTIONS MENU .....	44
6.0.0	Zoom Type .....	44
6.0.1	Icon Size .....	45
6.0.2	Place Name Size .....	45
6.0.3	Perspective View .....	46
6.0.4	Dynamic Nav-Aids .....	47
6.0.5	Safety Status Bar (DSI - Data Safety Indicator) .....	47
6.0.6	Satellite Imagery .....	48
6.0.7	Currents Prediction .....	49
6.0.8	Chart Language .....	50
6.0.9	Pictures or Diagrams .....	50
How to show the Pictures or Diagrams of a Object .....	51	
6.0.10	Enhanced Port Info .....	52
<b>7.</b>	<b>CREATING MARKS .....</b>	<b>53</b>
7.0	CREATING A NEW MARK USING THE CHART PAGE .....	53
7.1	EDITING A MARK .....	53
7.1.0	Deleting a Mark or Waypoint .....	54
7.1.1	Moving a Mark or Waypoint .....	54
7.2	MARKS/WAYPOINTS LIST .....	55
7.3	CREATING/MODIFY A NEW MARK IN THE USER POINTS LIST .....	56
7.4	GOTO CURSOR, ROUTE AND MARK .....	57
<b>8.</b>	<b>MAN OVER BOARD (MOB) FUNCTION .....</b>	<b>59</b>
8.0	PLACING A MOB POINT .....	59
8.1	DELETING A MOB POINT .....	59
<b>9.</b>	<b>ROUTES .....</b>	<b>60</b>
9.0	CREATING A ROUTE USING WAYPOINTS .....	60
9.1	CHANGING THE NAME OF A ROUTE .....	61
9.2	CREATING AN OLYMPIC ROUTE .....	61
9.3	MAKING ADDITIONAL ROUTES .....	62
9.4	CREATING A ROUTE USING MARKS ON THE CHART PAGE .....	62
9.5	INSERTING A WAYPOINT INTO A ROUTE .....	63
9.6	GOTO A ROUTE .....	63
9.6.0	Using [GOTO] to select Route .....	63
9.6.1	Using the ShuttlePoint knob .....	64
9.7	DELETING A ROUTE .....	64
9.8	OTHER SETTINGS IN ROUTE MENU .....	65
9.8.0	Route Check .....	65
<b>10.</b>	<b>TRACKS .....</b>	<b>67</b>
10.0	TRACKING .....	67

10.0.0	Saving and starting a new Track .....	68
10.0.1	Deleting a Track .....	68
10.0.2	Other settings .....	68
10.1	TRIP LOG .....	69
10.1.0	Using the Trip Log .....	69
10.1.1	Setup / Reset .....	69
<b>11.</b>	<b>USER C-CARD .....</b>	<b>70</b>
11.0	USER C-CARD MENU .....	70
11.0.0	Formatting the optional User C-CARD .....	70
11.0.1	Transferring files to the optional User C-CARD .....	71
11.0.2	Loading a file from the optional User C-CARD .....	71
11.0.3	Deleting a file from the optional User C-CARD .....	71
11.0.4	Changing the optional User C-CARD .....	71
<b>12.</b>	<b>PAGES .....</b>	<b>72</b>
12.0	CHART PAGE .....	73
12.0.0	Focus Soft Key on Dual Chart Page .....	74
12.0.1	Single Chart Page .....	75
12.0.2	Window Selections .....	75
12.0.3	Customizing the Data Windows .....	75
12.0.4	Additional Functions on Chart Page .....	77
12.0.5	Turning Off Information on Icon Points .....	77
12.0.6	Display Mode .....	77
12.0.7	Marine Settings .....	78
12.0.8	Depth Settings .....	79
12.0.9	Land Settings .....	79
12.0.10	Chart Settings .....	80
12.0.11	Underwater Objects Settings .....	81
12.1	CUSTOMIZING CHART SETTINGS .....	81
12.2	NAVIGATION PAGE .....	82
12.3	HIGHWAY PAGE .....	83
12.4	CELESTIAL PAGE .....	83
12.5	GPS STATUS PAGE .....	84
12.5.0	Setup Menu .....	85
12.5.1	WAAS/EGNOS Setting .....	85
12.6	NMEA DISPLAY PAGE .....	85
Changing the NMEA Page Windows .....		86
12.7	NMEA DATA PAGE .....	86
12.8	NMEA TREND PAGES .....	87
12.9	VHF DIGITAL SELECTIVE CALLING .....	88
12.9.1	Distress Call .....	89
12.9.2	Position Request .....	89
<b>13.</b>	<b>ADVANCED SETTINGS .....</b>	<b>90</b>
13.0	INPUT/OUTPUT (NMEA, AIS, RADAR) .....	90
13.0.0	Input .....	90
13.0.1	Ouput .....	90
13.1	NAVIGATE .....	91
13.1.0	Loran TD .....	91
13.2	COMPASS .....	92
13.3	ALARMS .....	92
13.4	SIMULATION .....	93

13.4.0	Navigating a Route in Simulation mode .....	93
13.5	DSC POLLING .....	94
<b>14. AIS</b>	.....	<b>95</b>
14.0	SYSTEM DEFINITIONS .....	95
14.1	MENU .....	96
14.2	AIS SETUP .....	96
14.3	QUICK INFO ON AIS TARGET .....	96
14.4	LIST .....	97
14.5	AIS TARGET COLORS .....	97
<b>15. C-WEATHER SERVICE</b>	.....	<b>99</b>
15.0	C-WEATHER SERVICE MENU .....	99
15.0.0	Download .....	99
15.0.1	Copy From Memory CARD .....	100
15.0.2	Forecast .....	100
15.0.3	Real Time View .....	100
15.0.4	Type of Data .....	100
<b>16. MOBILARM</b>	.....	<b>101</b>
16.0	MOBILARM-GPS CHART PLOTTER CONNECTION .....	101
16.1	SOFTWARE SETUP .....	102
16.2	MOBILARM STATUS .....	102
16.3	MOBILARM PTX .....	103
16.3.0	MOBILARM MOB alert is received .....	103
16.4	PLACING CURSOR ON THE PTX ICON .....	104
16.4.0	Delete PTX .....	104
16.4.1	Goto PTX .....	104
16.4.2	The MOBILARM Alarm Status List .....	105
<b>17. TROUBLESHOOTING</b>	.....	<b>106</b>
<b>18. TECHNICAL TESTS</b>	.....	<b>107</b>
18.0	SYSTEM TEST .....	107
18.0.0	RAM Menu (reset) .....	107
18.0.1	DIM Menu .....	107
18.0.2	Cartridges (used by Standard Horizon Technicians) .....	108
18.0.3	Serial Ports (used by Standard Horizon Technicians) .....	108
<b>19. SPECIFICATIONS</b>	.....	<b>109</b>
19.0	OPTIONAL FF525 FISH FINDER SPECIFICATIONS .....	110
19.1	OPTIONAL WAAS GPS RECEIVER SPECIFICATIONS .....	111
<b>20. APPENDIX: TERMS</b>	.....	<b>112</b>
<b>ANALYTICAL INDEX</b>	.....	<b>114</b>

---

# 1. INTRODUCTION

---

Congratulations on your purchase of the Standard Horizon GPS Chart Plotter. Whether this is your first Navigation device, or if you have other STANDARD HORIZON equipment, STANDARD HORIZON organization is committed to ensuring your enjoyment of this Navigation device. STANDARD HORIZON technical support personnel stand behind every product we sell. Our Product Support team invites you to contact us should you require technical advice or assistance, at 800/767-2450 or [marinetech@vxstdusa.com](mailto:marinetech@vxstdusa.com).

## 1.0 GENERAL INFORMATION

---

The CP590 is precision-crafted high-performance receiver for the Global Positioning System (WAAS GPS) constellation of satellites that provide precise location data with a host of navigation features and are ideal for nautical use and sealed against water ingress. The GPS Chart Plotter is housed in rugged, impact-resistant cases with outstanding ergonomic design for effortless operation. The CP590 is IP56 water resistant.

The advanced features of the GPS Chart Plotter include:

- Built-In Charts for coastal navigation of USA including Alaska, Hawaii and Great Lakes, Canada, Bahamas, Caribbean, Cuba, Puerto Rico, and Central America
- 12-inch sunlight-readable display
- Full VGA 800 x 600 high resolution LCD
- WAAS GPS Antenna with 15 meter of cable
- 2 Video camera or DVD (NTSC or PAL) Inputs
- 1 VGA Video Output, connects to compatible TV or monitor
- Customizable *"picture-in-picture"* video window
- Fish Finder capable when the optional FF525 50/200kHz (Black Box Fish Finder) are installed
- Capable of using a RADAR Antenna (USA ONLY)
- Dual chart window with independent zoom levels
- Selectable sailboat and power boat ship icons with red and green for port and starboard
- Compass Rose indication around ship icon
- Satellite images on base chart
- Route Checking
- Color Targets AIS
- Dedicated AIS List page
- Navigate to an Olympic Route
- SOG Speed Filter function to resolve erratic speed readings in rough seas
- C-MAP BY JEPPESEN NT+/MAX cartography compatible
- Improved Worldwide background showing detail up to 2.0 Nm
- Connections to and from STANDARD HORIZON compatible DSC VHF's for Distress and Position Request calls
- 3000 Marks / 50 Routes / 10000 Track Points
- 3-years waterproof warranty



## 1.1 PACKING LIST







When the package containing the Navigation device is first opened, please check for the following contents. If any parts are missing contact the dealer this Navigation device was purchased from. Accessories and replacement parts may be ordered from STANDARD HORIZON's Parts Department at 741/827-7600 extension 6800 or email at [yaesuparts@vxstdusa.com](mailto:yaesuparts@vxstdusa.com).

PART CODE	ITEM
S8002251	External bracket (includes two knob-screws)
S8002252	Dust cover
T9101553	PWR ACC1 & ACC2 cable
S8002253	Flush mounting screws
Q7000619A	GPS ANT Unit GSU-5H Series UX0GSU51SD*
EM054U100	Owner's Manual
EM023U511	Quick Reference Guide

NOTE: \*RPT is a revision number

## 1.2 OPTIONAL ACCESSORIES

		
<b>FF525 Fish Finder</b>	<b>ACVC10 Video Adapter cable</b>	<b>VGAC10 VGA Adapter cable</b>

						
<b>DST520</b> 2" Nylon Thru-hull Depth & Temp	<b>DST521</b> Transom Mount, Depth, Speed & Temp	<b>DST523</b> 2" Bronze Thru-hull Depth & Temp	<b>DST525</b> In-hull Mount, Depth	<b>DST526</b> Bronze Thru-hull, Triducer, Depth, Speed & Temp	<b>DST527</b> In-hull Mount, Depth	<b>DST528A</b> Thru-hull, Long stem, Depth & Temp
<b>600W Transducers</b>				<b>1000W Transducers</b>		

## 1.3 RADAR UNIT SUPPLIED BY SI-TEX USA

The Radar antennas are supplied by SI-TEX (631) 996-2690 in the USA and Canada. Refer to the table below for compatible models:

MODEL NUMBER	DESCRIPTION
MDS-1	2kW 24 Mile 12.4" diameter Radome Antenna
MDS-8	2kW 24 Mile 20" diameter Radome Antenna
MDS-9	4kW 36 Mile 23.5" diameter Radome Antenna
MDS-10-4	4kW 48 Mile 4Ft Open Array
MDS-10-5	4kW 48 Mile 5Ft Open Array

### NOTE

Please contact to the Standard Horizon Authorized dealer, STANDARD HORIZON product technical support or SI-TEX directly for additional information.



---

## 2. GETTING STARTED

---

Through this manual you will see highlighted words. Please refer to the legend below:

<b>[MENU]</b>	If you see brackets around a bold and capital letter word this refers to a key press.
<b>[CHART]</b>	If you see brackets around a bold and small capital letter word this refers to a Soft Key press.
<b><u>GENERAL SETUP</u></b>	When a word(s) is bold capital letters and underlined, this refers to a menu selection item.

---

### 2.0 MOUNTING THE GPS CHART PLOTTER

---

The CP590 is supplied with hardware for bracket or flush mounting. Below are pictures showing actual examples of the two types of installation.

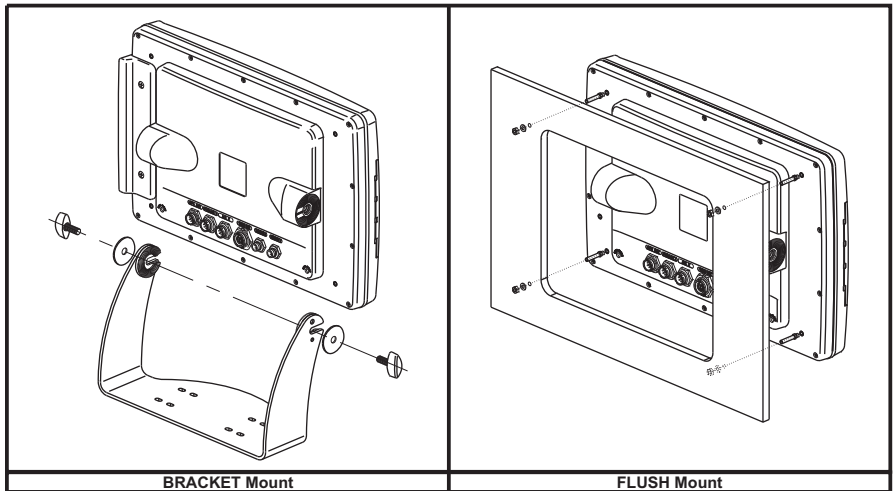

---

#### 2.1 BRACKET MOUNTING

---

Before installing ensure the area the bracket is mounted to is strong enough to support the weight of the GPS Chart Plotter especially while under way. After the location is found, attach the mounting base to the area using the supplied hardware.

The CP590 is supplied with a flush mount template for the cutout hole and screw holes required to install the GPS Chart Plotter.

#### NOTE

Before drilling holes make sure there is enough room to mount the GPS Chart Plotter and there are no obstructions.

1. After a location is found, peel the template label from the backing and apply the label to the mounting area.

2. Drill a hole in one area of the cutout area that will allow the blade of a jigsaw to be inserted. Insert and cut out the area on the panel using the jigsaw.
3. Next drill the four holes required to insert the GPS Chart Plotter with the mounting studs.
4. Install the mounting studs on the GPS Chart Plotter and insert into the mounting hole.
5. Attach the GPS Chart Plotter to the mounting location by attaching the supplied hardware to the mounting studs.

## 2.3 EXTERNAL GPS ANTENNA MOUNTING

The CP590 is supplied with a external GPS WAAS Antenna with 15 meters of routing cable. This antenna is designed to be mounted on a base, installed on an extension or even flush mounted.

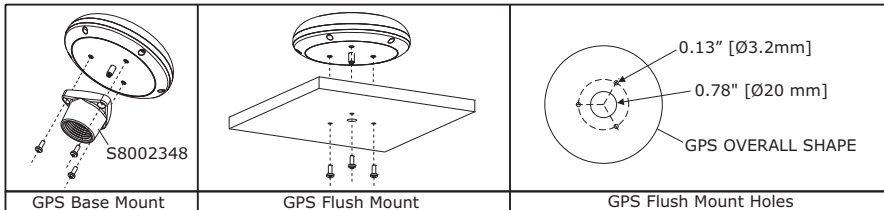

Choose a location for the antenna that has a clear view of the sky and is not located within 3 Ft of a Radar or other transmitting antennas. Ensure there are no major obstructions or fixtures in the immediate proximity to the antenna. The antenna relies on direct "line of sight" satellite reception. If you are unsure of the chosen location, temporarily mount the antenna in the desired location to verify correct operation. If mounted close to Radar, after the GPS Chart Plotter has a fix, turn on the Radar to ensure the GPS Chart Plotter holds the fix (use the GPS Status Page). The thread used on the antenna is an industry standard (1 inch 14TPI) used on a wide range of mounting brackets.

### NOTE

The antenna cable can be cut and spliced to ease installation. Care must be taken when reconnecting the antenna cable to protect from water and corrosion.

### 2.3.0 Flush mounting the antenna

### NOTE

Before drilling holes, it is recommended the antenna be positioned where the location is planned, cable connected to the GPS Chart Plotter and power turned On to ensure a GPS Fix is received.

1. Remove the threaded base from the antenna dome.
2. To ease installation a flush mounting template for the antenna has been included.
3. Apply the mounting template sticker to the area that was verified for GPS reception.
4. Then, drill out the 0.78" (20mm) and 0.13" (3.2mm) holes, and remove the template.
5. Insert the cable into the 0.78" (20mm) hole and route to the GPS Chart Plotter.
6. Apply a small amount or RTV to the underside of the antenna.
7. Place the antenna and then screw it into place using the screws.

### NOTE

In some cases the screw may not be long enough. If this happens simply apply more RTV to the underside of the antenna to glue it into place.

### 2.3.1 GPS cable

The following table is to be used as a reference.

#### Smart GPS Cable

Pin	Wire Color	Description
1	Red	Battery Positive
2	Green	Smart GPS NMEA Input
3	Brown	Smart GPS NMEA Output
4		NC
5		NC
6	Black/Yellow	Battery Ground

### 2.3.2 GPS Antenna connections

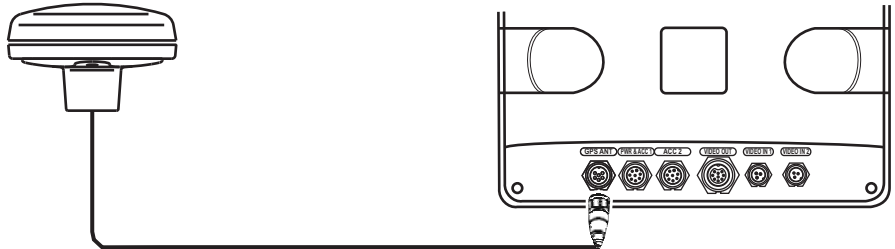

## 2.4 PWR CABLE

### 2.4.0 Battery Connections

1. The CP590 is supplied with a fuse and holder. This fuse should be installed into the Black wire to protect the NMEA Output/Input circuits from becoming damaged, however it can also be installed in the red wire.
2. Two Accessory cables (exactly the same cable) are supplied with the CP590.
3. Connect one of the Accessory cables to the PWR ACC 1 connector on the rear panel. The other Accessory cable is used to connect to ACC 2 connector.
4. This cable has many wires, however only the RED and BLACK wires are used to connect to a switched battery supply. Refer to the image below. For additional connections refer to NMEA connections.

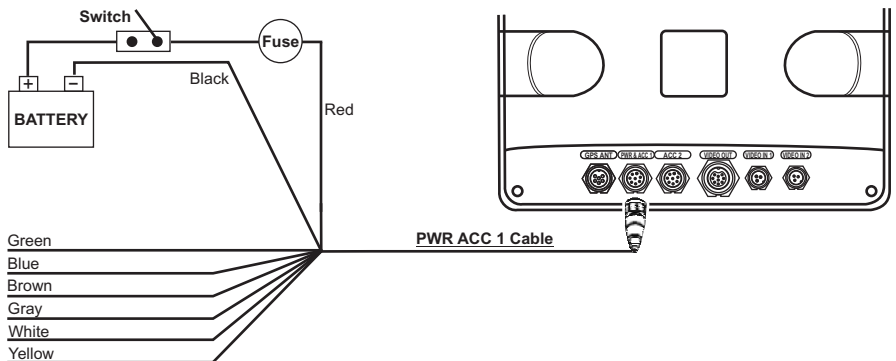

## 2.4.1 NMEA Connections

The CP590 PWR ACC 1 connector is also used to attach NMEA devices\* such as AIS Receivers, digital instruments, Personal Computers, autopilots and the optional FF525 BLACK BOX FISH FINDER.

\*NOTE

RS232 not opto-isolated electrical interface.

PIN	WIRE COLOR	FUNCTION	CONNECTION EXAMPLE
1	BLACK	Battery Ground	
2	RED	Battery Positive	
3	GREEN	NMEA Common	Common (ground) for NMEA devices*
4*	BLUE	Port1 Input	Connect to Output of NMEA device*
5	BROWN	Port1 Output	Connect to Input of NMEA device*. Default is NMEA-0183 with GLL, RMB, RMC and XTE sentences
6	GRAY	Port2 Input	Connect to Output of NMEA device*
7	WHITE	Port2 Output	Connect to Input of NMEA device*. Default is NMEA-0183 with GLL, RMB, RMC and XTE sentences
8**	YELLOW	Port3 Output	Connect to Input of NMEA device*. Default is NMEA-0183 with APA, APB, XTE, COG and BOD sentences

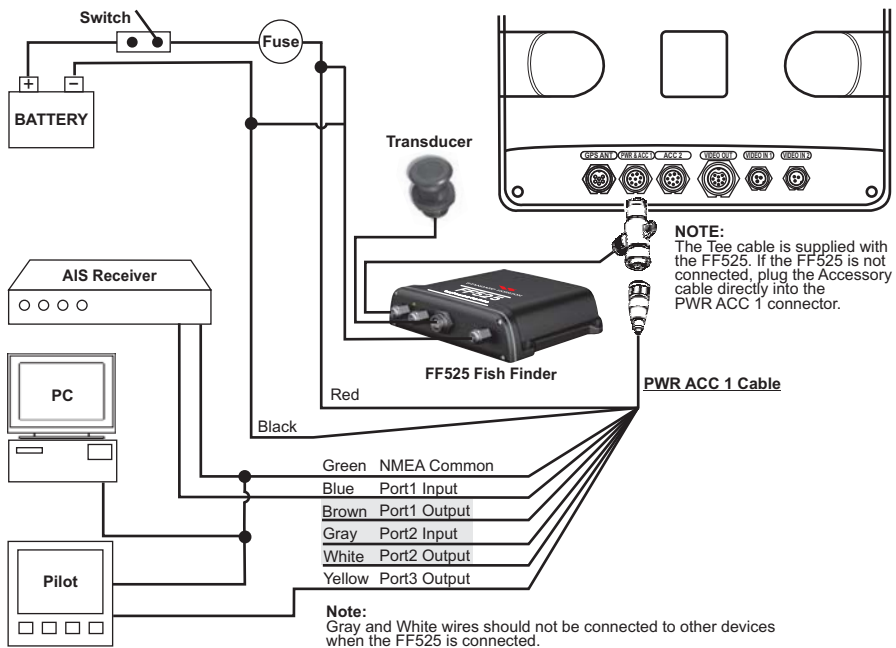

\*NOTE: AIS RECEIVER OPTION

For more information on AIS refer to Section 14.

The CP590 has to be set up to be able to receive NMEA information from the AIS receiver. The GPS Chart Plotter reads the AIS NMEA message VMD, type 1, 2, 3 and 5 for AIS Class A and type 18, 19, 24 for AIS Class B. Select the used port and transmission speed by following the procedure:

1. From the Chart page, press **[MENU]**, move the ShuttlePoint knob to highlight **SETUP MENU** and press **[ENT]**.
2. Move the ShuttlePoint knob to highlight **ADVANCED SETUP** and press **[ENT]** or move the ShuttlePoint knob to the right.

3. Move the ShuttlePoint knob to highlight **IN/OUT CONNECTIONS** and press [ENT] or move the ShuttlePoint knob to the right.
4. Move the ShuttlePoint knob to highlight **PORT1 INPUT** and press [ENT] or move the ShuttlePoint knob to the right.
5. Move the ShuttlePoint knob up/down to select **AIS 38400** and press [ENT] or move the ShuttlePoint knob to the right.
6. Press [CLR] or move the ShuttlePoint knob to the left until the Chart page is shown.

\*\*NOTE: AUTOPILOT CONNECTION

Care must be taken when connecting the GPS Chart Plotter to an Autopilot. Normally Port3 (Yellow wire) will be used to connect to an Autopilot input, however older autopilots may not be able to read the sentences due to the talker ID that is being used (II Integrated Instrument). If the autopilot connections are made to Port3 (Yellow wire) and the autopilot is not reading the sentences, change the connections to Port1 (Brown) or 2 (White) and change the sentences to APA, APB, XTE, COG and BOD.

### PERSONAL COMPUTER CONNECTION / SETUP

Any of the NMEA ports can be used to send and receive Marks and Routes to PC programs.

The CP590 uses NMEA WPL and RTE sentences to share information from the PC. Refer to the table below for connection to a Serial DB9 connector.

DB9 PIN	CONNECTION	CP590
2	Receive +	NMEA Out
3	Transmit +	NMEA In
5	Signal Common	Green wire

### SETTING UP THE COM PORT

The Send and Receive default is Port1. To change the Port follow the directions below:

1. Press [MENU] twice. Move the ShuttlePoint knob to highlight **ADVANCED SETUP** and press [ENT].
2. Move the ShuttlePoint knob to highlight **IN/OUT CONNECTIONS** and press [ENT].
3. Move the ShuttlePoint knob to highlight **SEND/REC RTE&MARKS** and press [ENT].
4. Choose the desired Port number and press [ENT].
5. Press [CLR] until the Chart page is shown.

### SEND OR RECEIVE RTE AND WPL

1. Press [MENU], move the ShuttlePoint knob to highlight **USER POINTS** and press [ENT].
2. Move the ShuttlePoint knob to highlight **Marks/Wpts** and press [ENT].
3. After the messages are sent or received a popup window will be shown.

## 2.4.2 ACC 2 Connector

This cable allows connections to a VHF, NMEA device with NMEA Output or the Input of the optional Radar Antenna.

PIN	WIRE COLOR	FUNCTION	CONNECTION EXAMPLE
1	BLACK	No Connection	
2	RED	No Connection	
3	GREEN	NMEA Common	Common (ground) for NMEA devices**
4	BLUE	Port4 Input	Connect to Output of NMEA device**
5	BROWN	Port4 Output	Connect to Input of NMEA device**. Default is NMEA-0183 with GLL, RMB, RMC and XTE sentences
6*	GRAY	Port5 Input	Connect to Output of NMEA device**
7*	WHITE	Port5 Output	Connect to Input of NMEA device**. Default is NMEA-0183 with GLL, RMB, RMC and XTE sentences
8	YELLOW	No Connection	

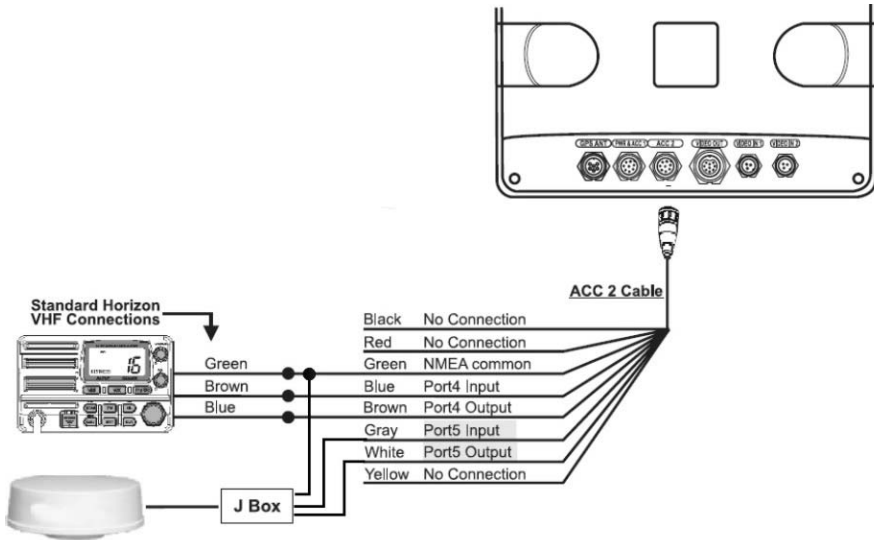

\*NOTE: RADAR Antenna connection (optional)

For Radar Installation instructions visit [www.standardhorizon.com](http://www.standardhorizon.com) and click on Owner's Manuals and click to down load files called Radar Installation Manual and Radar Operation Manual.

\*\*NOTE

RS232 not opto-isolated electrical interface.

### VHF Connections

To connect the CP590 to a VHF, a port will be needed to be selected. Refer to the ACC 2 connections for a connection example.

#### NOTE

The optional FF525 uses port 2 when connected and the optional Radar Antenna uses port 5. When these optional devices are connected use port 1, 2 or 4 Input and Output to connect to the VHF radio. Some manufacturers of DSC VHF's are not capable of receiving NMEA DSC sentences from the CP590. Refer to the Owner's Manual and confirm the VHF can receive NMEA DSC and DSE sentences.

## VGA Video Output

The CP590 has:

- **One VGA output**

Allows connection to a compatible TV or monitor using the optional VGAC10 adapter cable.

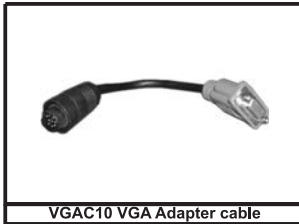

- **Two NTSC or PAL Video Inputs**

NTSC or PAL video inputs allowing a camera, DVD or VCR. To connect a video source use the optional ACVC10 cable (3 pin to RCA phone adapter).

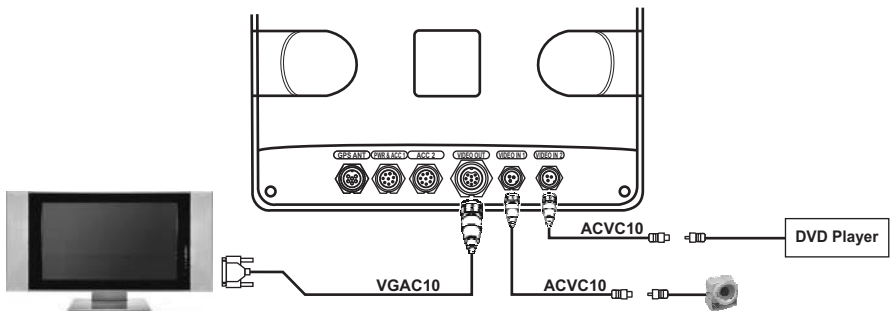
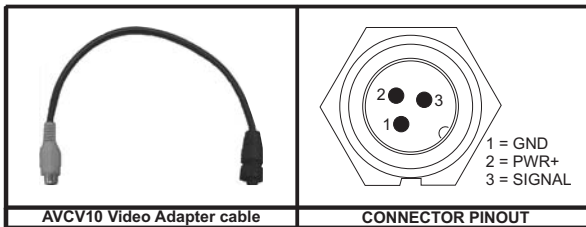

The CP590 has the capability to select the Video Input in three ways.

**a) From the menu**

1. Press **[MENU]** twice and move the ShuttlePoint knob to highlight **VIDEO INPUT** and press **[ENT]**.
2. A menu appears with the following options:
  - **ACTIVATE VIDEO**, the possible choices are Full Screen View, PiP (Picture in Picture) View and Auto Switch.
  - If **Full Screen View** is chosen, the GPS Chart Plotter will show a warning message with the instructions to adjust the image from the Video Input. If the user agrees to proceed, the image from the video input will be shown.

- If **Picture in Picture (PiP) View** is chosen, a Video Input image can be shown on a window and placed over the selected page at full screen. By moving the ShuttlePoint knob, the PiP image is moved. When the focus is on the PiP image, press **[CLR]** to close the PiP image.
- If **Auto Switch** is chosen, all the menus will be closed and the video input will be shown switching between the Video Input Full View (if connected) and the selected page. See next section for details of setting up the switching times. If the user agrees to proceed, the image from the video input and the GPS Chart Plotter page will be shown intermittently. The intermittence time is selected by Switching Timeout item.
- **SWITCHING TIMEOUT**, the possible choices are 5,10,30 sec, 1, 5, 10 min. Allows selecting the timing to change from Video Input and GPS Chart Plotter display.
- **RESTORE DEFAULTS**, allows restoring the factory defaults for the Input picture adjustment. When Restore default is executed, the message "OK" is shown next to the selected menu item.

#### NOTE

---

If the video signal is not present on the video connector, the corresponding item in the menu will be shown in gray and will not be selectable.

---

#### b) Quick Activation by pressing **[CLR]** for 1 second

Pressing and holding **[CLR]** for 1 second from the Chart page Display or from any main page (Navigation, Highway, Celestial, GPS Status, DSC, NMEA DISPLAY); the following Soft Keys are shown: **[FULL SCREEN]**, **[PIP VIEW]**, **[AUTO SWITCH]**. **If no video signal is detected on the Video Input connector, the Soft Keys will be shown in gray and will not be selectable.**

#### c) Quick Activation by Soft Keys

It is possible to assign the Video Input mode to any of the Soft Keys. Press one of the Soft Keys, the Soft Keys functions are shown. Pressing and holding for 1 second one of the Soft Keys, the Soft Keys customization list will be shown. By selecting **VIDEO** option it will be possible to assign the Soft Key to execute the Video Input function. Once the Soft Key has been assigned to Video Input, its label will show the message **[VIDEO]**. **If [VIDEO] is pressed, the Soft Keys will be assigned this way: [FULL SCREEN], [PIP VIEW], [AUTO SWITCH]. From now on, the functioning is identical to case b).**



---

## 3. CONTROLS AND INDICATORS

---

### NOTE

Throughout this Owner's Manual same conventions are used. See the legend below:

**[MENU]** If you see brackets around a bold and capital letter word this refers to a key press.

**[CHART]** If you see brackets around a bold and small capital letter word this refers to a Soft Key press.

**GENERAL SETUP** When a word(s) is bold capital letters and underlined, this refers to a menu selection item.

---

### 3.0 CONTROLS AND CONNECTIONS

---

Using the keys located on the front panel controls the CP590. These labelled keys are dedicated to specific functions. As you press a key, a single audio beep confirms the key action; every time a key press is not valid, three rapid beeps sound to indicate that the key action is not valid. There is also a ShuttlePoint knob to move the cursor across the screen.

#### The ZOOM IN and ZOOM OUT keys

- Pressing **[ZOOM IN]** shows more detail of a smaller area, by changing the Chart Scale and zooming in on your display.
- Press **[ZOOM OUT]** to change the scale and show a wider, otherwise less detailed view.
- Pressing and holding **[ZOOM IN]/[ZOOM OUT]** allows for quick zoom, that is the fast change of the chart scale where only the land areas are drawn.
- When **[ZOOM IN]/[ZOOM OUT]** is released all chart details are shown.

### NOTE

The GPS Chart Plotter contains a Worldwide background that allows you to zoom in to 2 Nm. For more detail, a C-MAP By JEPPESEN NT\*/MAX C-CARD must be purchased and installed.

---

#### The ShuttlePoint knob

- The ShuttlePoint knob moves the cursor around the Chart Page (cursor mode) and highlights menu items.
- It changes the GPS Chart Plotter from Home mode to Cursor mode on the chart screen.
- For a detailed explanation of Cursor VS Home mode refer to Par. 3.1.1.

#### The ENT key

Press **[ENT]** to select the desired option or to confirm the selection.

#### The CLR key

- When on the Chart Page, press **[CLR]** to set Home Mode.
- Press **[CLR]** to clear a selected function, leave a menu, step backwards in a menu or exit a menu.

#### The MENU key

- Selects the Main Menu.
- When in the Setup Menu mode, moving the ShuttlePoint knob to the right enters a selection and moving the knob to the left clears the function.
- Pressing and holding **[MENU]** for 3 seconds allows you to change the fields contained within the data windows while on the Chart, Navigation, Highway, GPS Status or NMEA Display page.

### The GOTO key

- This key is very useful when you desire to start navigating (goto) to a destination point.
- When pressed, a popup window will be shown allowing you to select to start navigating to a Mark, a Route or the position of the cursor.
- To stop navigation to a point, press **[GO TO]** and select Stop in the popup window.

### The MARK key

This key places a Mark under the ship's position when in Home Mode. When the cursor is shown and **[MARK]** is pressed it will place a Mark under the location of the cursor.

### The ROUTE key

- When pressed places a Waypoint.
- Succeeding presses place more Waypoints to form a Route.

### The PWR key (Backlight and Contrast)

- Press and hold **[PWR]** to turn the GPS Chart Plotter On or Off.
- Once on, press **[PWR]** to show and change the Contrast and Backlight settings.

### The MOB key

When pressed the GPS Chart Plotter automatically places a Mark on the Chart Page under the boat's position to aid in the rescue or a person that may have fallen aboard. To stop navigating, press **[GOTO]**, select **STOP** and press **[ENT]**.

### The INFO key

A dedicated key that allows searching the optional C-MAP BY JEPPESEN NT\*/MAX C-CARD for Port Services, Ports, Tide Stations, Wrecks, Obstructions, Points Of Interest, Lakes Information, Lakes By Name, User Points, GPS Coordinates or Information on any point on the Chart.

### The Soft Keys

The 6 keys in the bottom of the front panel (hereinafter named Soft Keys) have different functions associated depending on the software: their labels are shown on the screen immediately above the keys (the user can customize the function associated).

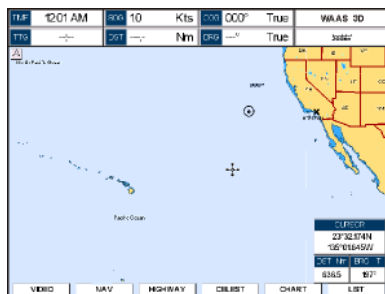

Figure 3.0 - Soft Keys

These keys allow quick selection to the many pages the GPS Chart Plotter has. These keys can be customized to your preference, however from the factory the keys are preprogrammed with the following pages. From left to right VIDEO, NAV, HIGHWAY, CELEST, CHART, LIST. Press any of the keys and you will see popup windows above the keys. To go to a specific page press the key with the desired popup window. The popup windows will automatically disappear if a key is not pressed or can be removed by pressing **[CLR]**.

### 3.0.1 The alphanumeric keys

The 10 alphanumeric keys are used for entering in alphanumeric data.

For alphanumeric input: pressing the key the first time enters the first letter, the second time it enters the second letter, the third time it enters the third letter; the fourth time it enters the number. After a short time the entered character (letter or number) is confirmed and the cursor is moved to the next location.

For numeric input: to enter a number in a Lat Lon: press the key of the number you wish to enter, continue pressing the numbered keys until the Lat Lon is entered. The cursor is moved to the next position. Pressing the ShuttlePoint knob up/down changes the value; pressing the ShuttlePoint knob left/right moves the cursor to the previous/next location.

## 3.1 GETTING STARTED

The Getting Started section will take you through the frequently used operations and assist you to customize the look of the GPS Chart Plotter.

### 3.1.0 Power On, Off and ShuttlePoint Knob operation

1. Press and hold **[PWR]** until the display shows the Start-Up page (see the following picture). To turn Off, press and hold **[PWR]** until the display turns Off.

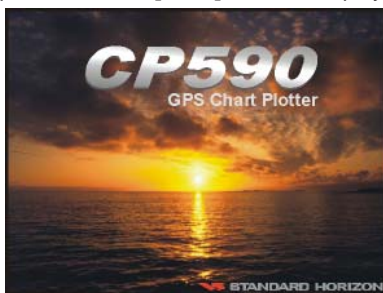

Figure 3.1.0 - Start-Up page

2. When the power is first turned on, two pages the start-up page and the Caution pages are briefly shown before the GPS Status page.

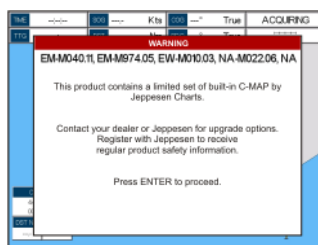
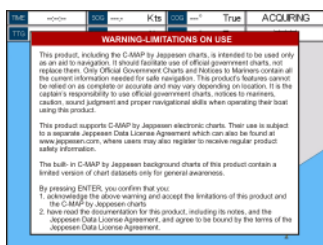

Figure 3.1.0a - Caution pages

#### NOTE

The Caution page on the left is shown only if the data C-CARD is over one year old.

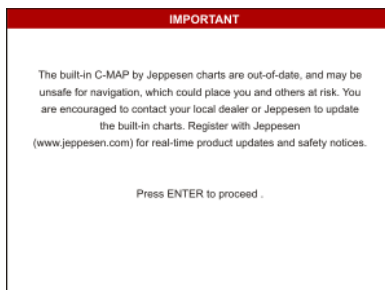

Figure 3.1.0b - Built-In Charts warning pages

- When the GPS Chart Plotter is first turned on it will take some time for the GPS to acquire a fix of your position. Look closely at the GPS Status page and you will see satellites and relative signal strengths of each satellite. After a fix is received the GPS Chart Plotter will automatically switch to the Chart Page with the ship icon centered on the screen.

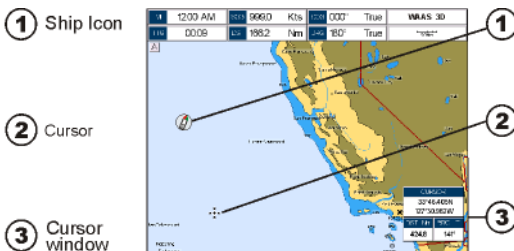
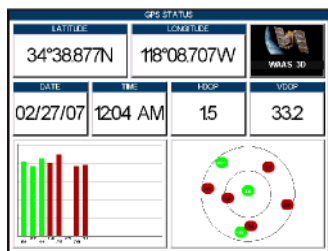

Figure 3.1.0c - GPS Status and Chart pages

- On the Chart page the ShuttlePoint knob is used to pan around the chart. Move the ShuttlePoint knob to the left and you will notice a cross hair  $\oplus$  appear, this is called the cursor.
- When you move the ShuttlePoint knob you will notice DST and BRG values in the Data window change. This shows the Distance and Bearing from the GPS Fix of your vessel to the position of the Cursor.
- If the cursor is moved to the edge of the screen the GPS Chart Plotter will automatically pan in the desired direction.

### 3.1.1 Cursor Vs. Home Mode

#### Cursor Mode

When the  $\oplus$  cursor is shown on the Chart Page, the chart plotter is in Cursor Mode. In Cursor Mode the position of the vessel will not stay in the center of the page and will move right off the edge of the screen (as your boat moves). Cursor Mode allows you to pan around and look at areas on the chart. In this mode you can also create Marks, Routes, measure distance and bearings from your current position.

#### Home Mode

When the  ship icon is shown on the Chart Page (cursor is not shown) you are in Home Mode. Now as the ship moves through the water the vessel's position will be kept in the center of the display.

## NOTE

To change from Cursor Mode to Home Mode press **[CLR]**.

### 3.1.2 Cursor and Menu selection speed

The GPS Chart Plotter allows you to control the speed the Cursor moves when the ShuttlePoint knob is pressed. To change the speed:

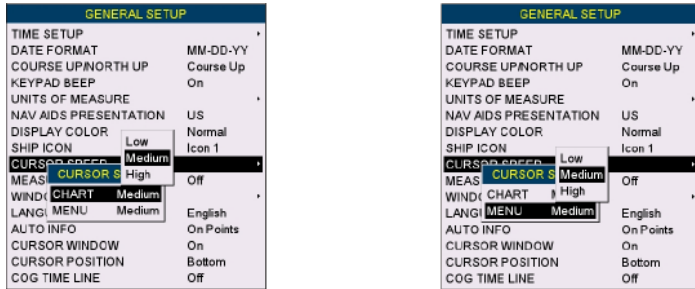

Figure 3.1.2 - Cursor Speed menu

1. Press **[MENU]**, move the ShuttlePoint knob to highlight **SETUP MENU** and press **[ENT]**.
2. Move the ShuttlePoint knob to highlight **GENERAL SETUP** and press **[ENT]** or move the ShuttlePoint knob to the right.
3. Move the ShuttlePoint knob to highlight **CURSOR SPEED** and press **[ENT]** or move the ShuttlePoint knob to the right.
4. The menu now shows two selections, Chart and Menu which allow the Cursor Speed to be selected as High, Medium or Low on the Chart Page or within the menus.
5. With **CHART** or **MENU** selected, press **[ENT]** or move the ShuttlePoint knob to the right. Move the ShuttlePoint knob to the desired setting and press **[ENT]** or move the ShuttlePoint knob to the right.
6. Press **[CLR]** until the menu disappears or an easier method is to press the ShuttlePoint knob to the left a few times.
7. Move the cursor on the Chart Page and see if the speed is to your liking.

### 3.1.3 Changing the Ship Icon

The cursor may be changed to any of the following. The default setting is Icon 6.

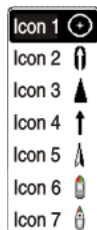

Figure 3.1.3 - Ship icons

1. Press **[MENU]**, move the ShuttlePoint knob to highlight **SETUP MENU** and press **[ENT]**.

2. Move the ShuttlePoint knob to highlight **GENERAL SETUP** and press [ENT] or move the ShuttlePoint knob to the right.
3. Move the ShuttlePoint knob to highlight **SHIP ICON** and press [ENT] or move the ShuttlePoint knob to the right to show the popup window with ship icons.
4. Move the ShuttlePoint knob to select the desired icon and press [ENT] or move the ShuttlePoint knob to the right to select a new icon.
5. Press [CLR] or move the ShuttlePoint knob to the left to exit the menu and show the Chart Page.

### 3.1.4 Changing the backlight and contrast

With the GPS Chart Plotter is turned on, briefly press [PWR] to show the backlight and contrast popup window. Move the ShuttlePoint knob to the left or right to adjust the LCD backlight intensity or up or down to change the LCD contrast. Press [ENT] to set.

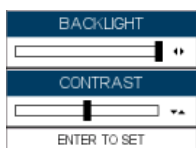

Figure 3.1.4 - Backlight and Contrast adjustment

### 3.1.5 Selecting North Up or Course Up

The default selection is **COURSE UP**: the top of the Chart page oriented so it will always show the area ahead of the direction your vessel is travelling.

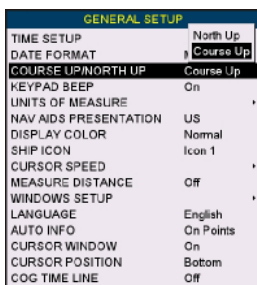

Figure 3.1.5 - Course Up/North Up menu

1. Press [MENU], move the ShuttlePoint knob to highlight **SETUP MENU** and press [ENT].
2. Move the ShuttlePoint knob to highlight **GENERAL SETUP** and press [ENT] or move the ShuttlePoint knob to the right.
3. Move the ShuttlePoint knob to highlight **COURSE UP/NORTH UP** and press [ENT] or move the ShuttlePoint knob to the right.
4. Another popup window will be shown with **NORTH UP** and **COURSE UP**, move the ShuttlePoint knob to the desired selection and press [ENT] or move the ShuttlePoint knob to the right.
5. Press [CLR] or move the ShuttlePoint knob to the left to exit the menu and show the Chart page.

## NOTE

When the GPS Chart Plotter is in COURSE UP mode a small arrow icon (↖) will be shown on the Chart page indicating North.

### 3.2 AUTOMATIC TIME

The time information supplied by the GPS satellites is in Universal Time Coordinates (UTC or Greenwich England Mean Time). To change the GPS Chart Plotter to display the local time, first you must figure out the offset and if it is Daylight Savings Time. For example on the West coast of the United States or Pacific Standard Time the offset needed would be  $-08:00$  or  $-07:00$  for Daylight Savings Time, Eastern Standard Time  $-05:00$  or  $-04:00$  for Daylight Savings Time.

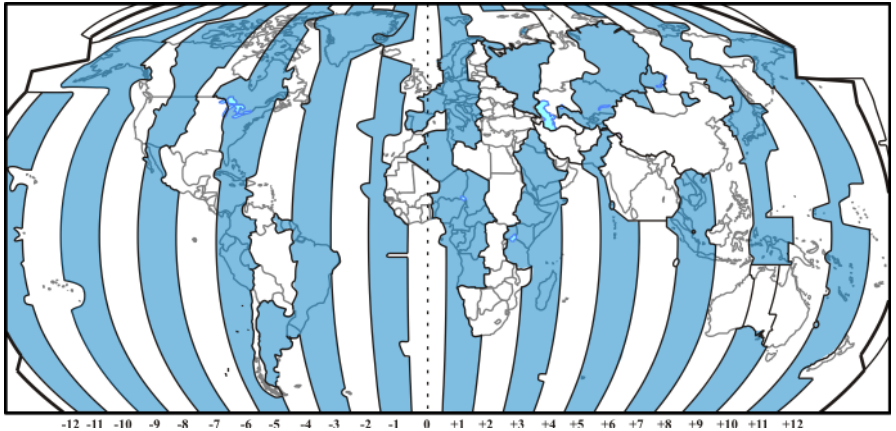

Figure 3.2 - Adjusting Time

The Time Setup menu allows you to enter a time zone offset for your location, selection to automatically adjust the time for daylight savings and to configure the time in 12 or 24 hour formats.



Figure 3.2a - Time Setup menu

## NOTE

By setting the time in the steps below, the time shown on the celestial page is automatically set up.

1. Press **[MENU]**, move the ShuttlePoint knob to highlight **SETUP MENU** and press **[ENT]**.
2. Move the ShuttlePoint knob to highlight **GENERAL SETUP** and press **[ENT]** or move the ShuttlePoint knob to the right.
3. Move the ShuttlePoint knob to highlight **TIME SETUP** and press **[ENT]** or move the ShuttlePoint knob to the right.
4. Move the ShuttlePoint knob to highlight **TIME ZONE** and press **[ENT]** or move the ShuttlePoint knob to the right.
5. Look at the table and find the time zone for your area. Move the ShuttlePoint knob up or down to select the desired zone and press **[ENT]**.
6. Next move the ShuttlePoint knob to highlight **DAYLIGHT SAVING** and press **[ENT]** or move the ShuttlePoint knob to the right.
7. Daylight Saving menu has 3 options:
  - 7.1 **OFF** Select Off when your location does not recognize Daylight Savings Time;
  - 7.2 **ON** Select On to manually turn Daylight Savings Time On. This is the default selection;
  - 7.3 **AUTO** When selected the Daylight Savings Time offset is automatically changed.
8. Press **[CLR]** or move the ShuttlePoint knob to the left until the Chart Page is shown.

### 3.3 SELECTING LORAN TD OR OTHER COORDINATE SYSTEM

The GPS Fix coordinates can be changed to show Latitude/Longitude, Loran TDs or UTM. Below is the window that will appear when customizing the Coordinate System.

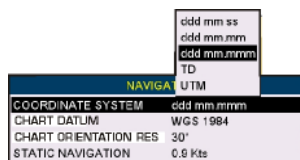

Figure 3.3 - Coordinate System menu

1. Press **[MENU]**, move the ShuttlePoint knob to highlight **SETUP MENU** and press **[ENT]**.
2. Move the ShuttlePoint knob to highlight **ADVANCED SETUP** and press **[ENT]** or move the ShuttlePoint knob to the right.
3. Move the ShuttlePoint knob to highlight **NAVIGATE** and press **[ENT]** or move the ShuttlePoint knob to the right.
4. Move the ShuttlePoint knob to highlight **COORDINATE SYSTEM** and press **[ENT]** or move the ShuttlePoint knob to the right.
5. Move the ShuttlePoint knob to highlight the desired coordinate type and press **[ENT]** or move the ShuttlePoint knob to the right.
6. Press **[CLR]** or move the ShuttlePoint knob to the left until the Chart page is shown.

## NOTE

If the TD is selected, you should set the Chain, Pair, ASF1, ASF2 and Alter. If the TD numbers are not correct the Pair letters may be backwards. Reversing the two letters usually solves this issue. Example: Y/Z change to Z/Y.



### 3.4 CHANGING THE CHART COLOR

The GPS Chart Plotter has preprogrammed settings allowing you to customize the look of the Chart page. The default is Sunlight, however there are other settings: Classic, NOAA, Night and Normal. Night is very useful during evening hours so not to impair night vision.

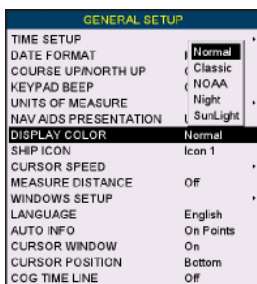

Figure 3.4 - Display Color menu

1. Press **[MENU]**, move the ShuttlePoint knob to highlight **SETUP MENU** and press **[ENT]**.
2. Move the ShuttlePoint knob to highlight **GENERAL SETUP** and press **[ENT]** or move the ShuttlePoint knob to the right.
3. Move the ShuttlePoint knob to highlight **DISPLAY COLOR** and press **[ENT]** or move the ShuttlePoint knob to the right.
4. A popup window will be shown with **Normal**, **Classic**, **NOAA**, **Night** and **Sunlight**. Move the ShuttlePoint knob to the desired selection and press **[ENT]** or move the ShuttlePoint knob to the right.
5. Press **[CLR]** or move the ShuttlePoint knob to the left to exit the menu and show the Chart page.

### 3.5 SELECTING LANGUAGE

To ease operation in different countries, the software includes translation and display of the following 16 languages:

- English
- German
- Swedish
- Danish
- Finnish
- Japanese
- Italian
- Spanish
- Portuguese
- Dutch
- Russian
- French
- Norwegian
- Chinese (Traditional)
- Greek
- Chinese (Simplified)

The translations are included in Menu descriptions, Soft Key labels and on Info Functions to ease operation. See also Par. 6.0.7

Sets the language to be displayed on menus, data pages, warning/alarm messages, full/quick info, list of objects found by find/nearest function, and on charts (such as place's names and buoy's names and so on). The selection now includes the capability to display languages in non-Latin characters (UNICODE format). To select the language you want:

1. Press **[MENU]**, move the ShuttlePoint knob to highlight **SETUP MENU** and press **[ENT]**.
2. Move the ShuttlePoint knob to highlight **GENERAL SETUP** and press **[ENT]** or move the ShuttlePoint knob to the right.
3. Move the ShuttlePoint knob to highlight **LANGUAGE** and press **[ENT]** or move the ShuttlePoint knob to the right.
4. Another popup window will be shown with the available languages, move the Shuttle-

Point knob to the desired language and press **[ENT]** or move the ShuttlePoint knob to the right.

- Press **[CLR]** repeatedly or move the ShuttlePoint knob to the left repeatedly to exit the menu and show the Chart page.

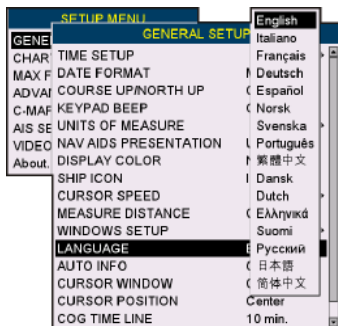

Figure 3.5 - Language Selection menu

#### NOTE

If the selected language is not available on cartographic data, English is used.

#### WARNING

If you have accidentally selected a language and are unable to return to the Language Selection menu, perform the following procedure:

- Select the Chart page.
- Press **[MENU]** two times, move the ShuttlePoint knob to highlight the first (top) selection in the menu and press **[ENT]**.
- Move the ShuttlePoint knob to highlight the **LANGUAGE** item and press **[ENT]**.
- A language window will be shown, select your language and press **[ENT]**.

### 3.6 SELECTING PAGES WITH SOFT KEYS

The Soft Keys located under the LCD are used to select the pages quickly without the need to go into the menu. The default pages are VIDEO, NAV, HIGHWAY, CELESTIAL, CHART and LIST. When one of the Soft Keys is pressed popup windows above each Soft Key are shown with the key description. Press the Soft Key with the desired page description and the GPS Chart Plotter will change to that page.



Figure 3.6 - Screen display pages

### 3.7 CUSTOMIZING THE SOFT KEYS

The Soft Keys can be individually customized from the default pages (discussed above) to the following: CHART, DUAL CHART, CHART/COMPASS, CHART/HIGHWAY, NAVIGATION, HIGHWAY, CELESTIAL, GPS STATUS, DSC LOG, DSC DIRECTORY, NMEA DISPLAY, NMEA DATA, DEPTH TREND, WIND SPEED TREND, TEMP TREND, SOG TREND, MARKS/WAYPOINTS, USER C-CARD, AIS LIST, FIND and VIDEO INPUT.

When the Optional FF525 50/200kHz BLACK BOX FISH FINDER is connected, any Soft Key can be customized to show FISH FINDER 50kHz, FISH FINDER 200kHz, FISH FINDER 50/200kHz, FISH FINDER 50kHz/CHART, FISH FINDER 200kHz/CHART screens. Also when a SI-TEX RADAR Antenna is connected (USA only), any Soft Key can be customized to show Radar pages, RADAR FULL, RADAR/CHART, RADAR OVERLAY and RADAR/FISH FINDER.

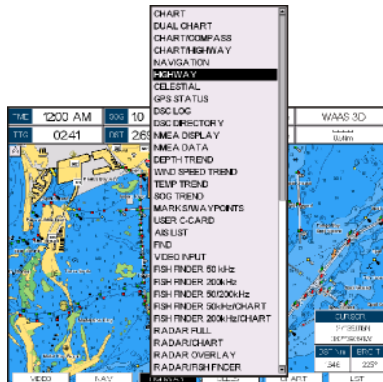

Figure 3.7 - Window options of the selected Soft Key

1. To change, momentarily press any of the Soft Keys, then press and hold the Soft Key you want to customize.
2. A popup window will be shown with the above settings.
3. Move the ShuttlePoint knob up or down to select the desired page.
4. Press [ENT] or move the ShuttlePoint knob to the right to save the page to the selected Soft Key.

### 3.8 SETTINGS IN GENERAL SETUP MENU

The **GENERAL SETUP** menu has other selections that allow you to customize the display. All selections are listed below:

<b>TIME SETUP</b>	Select the <b>Time Zone</b> offset, enable or disable <b>Daylight Saving</b> time and select the <b>Time Format</b> (switch between 12 or 24 hours time format).
<b>DATE FORMAT</b>	Select the Date format among <b>MM-DD-YY</b> (default), <b>DD-MM-YY</b> or <b>YY-MM-DD</b> .
<b>COURSE UP/NORTH UP</b>	Select <b>North Up</b> (the top of the page is fixed to North) or <b>Course Up</b> (the top of the page is orientated to the direction the vessel is heading. This is the default).
<b>KEYPAD BEEP</b>	Allows the beep produced when a key is pressed to be turned <b>On</b> (default) or <b>Off</b> .
<b>UNITS OF MEASURE</b>	Units of Measure can be selected for <b>Distance</b> , <b>Speed</b> , <b>Depth</b> , <b>Altitude</b> and <b>Temperature</b> : <b>Distance:</b> selections are <b>Nm</b> (Nautical Miles), <b>Sm</b> (Statue Miles), <b>Km</b> (Kilometres), <b>Nm+Ft</b> , <b>Nm+Mt</b> . Note when "Nm+Ft" is selected if the distance is less than 1.0 Nm, it turns to Ft. When "Nm+Mt" is selected if the distance is less than 1.0 Nm, it turns to Meters.

**Speed:** selections are **Kts** (knots), **MPH** (miles per hour), **Kmh** (kilometer per hour).

**Depth:** selections are **Ft** (feet), **FM** (fathoms) and **Mt** (meters).

**Altitude:** selections are **Ft** (feet) and **Mt** (meters).

**Temperature:** selections are **F** (Fahrenheit) and **C** (Celsius).

**NAV AIDS PRESENTATION** Allows the Nav Aids presentation to be drawn using NOAA symbology when **US** (default) is selected or International symbols when **International** is selected. When selected these functions affect how the icons for Lights, Signals, Buoys and Beacons are displayed.

**DISPLAY COLOR** Changes the background colors of the chart page to enhance the visibility of the screen depending on the surrounding light conditions. **Normal** is recommended when the GPS Chart Plotter is not exposed to the direct sunlight. When this mode is set the charts are displayed in order to use colors as similar as possible to ones used in the original paper charts. **Classic** uses vivid chart colors presentation. **NOAA** allows setting NOAA paper chart colors presentation. **Night** is recommended when the environment is dark in order to reduce the glare of the display. The GPS Chart Plotter displays charts and screen in darker colors. **SunLight** (default) is designed to enhance the visibility of the screen when the GPS Chart Plotter is exposed to sunlight. The charts are much brighter than in the other modes and the depth areas are filled with the white color so different depth areas are not easily distinguishable.

**SHIP ICON** Select from a variety of ship icons that represent your vessels position on the Chart Page. The default is Icon 6.

**CURSOR SPEED** Selects the speed among **Low**, **Medium** (default) and **High** for the cursor in the CHART page and within the MENU.

**MEASURE DISTANCE** When this function is On, and the ShuttlePoint knob is moved to a location where you want to start measuring a distance and press **[ENT]**. Move the ShuttlePoint knob to move the cursor to a second location where you want to finish measuring a distance and press **[ENT]**. A line will appear between the Start and Finish points and a popup window will be shown indicating the distance and bearing from the Start and Finish points. Press **[ENT]** to delete both points (Off is the default).

#### START point



#### FINISH point



**WINDOWS SETUP** This menu selection allows the data windows to be customized on the CHART PAGE and NAVIGATION PAGE (refer to section 12.0.0).

**LANGUAGE** Allows changing the language for menus and data screens.

**AUTO INFO** When the cursor is moved over a buoy, Mark or other item a popup window will show information of the item. This menu item allows the window to be turned Off, **On Points** (default) or **On All**.

#### Auto Info OFF



#### Auto Info ON POINTS



#### Auto Info ON ALL



**CURSOR WINDOW** By default when the cursor is moved a window is shown with the Lat/Lon Distance and Bearing from the vessels location to the cursor. This selection allows the window to be

turned On (default) or Off. The Cursor Window is automatically disabled when General is set in Windows Setup option.

### Cursor Window ON



### Cursor Window OFF

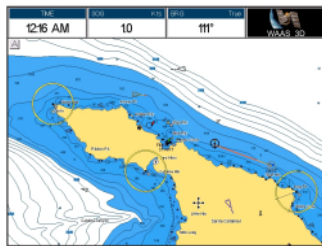

#### CURSOR POSITION

The position of the cursor can be customized so it is centered in the middle (if **Center** selected) or centered on the bottom of the Chart page (if **Bottom** selected, default).

#### COG TIME LINE

It is a line projected from the ship icon which indicates the distance your vessel will travel at the current speed. Selections are 2, 10 (default), 30 minutes, 1, 2 hours and infinite.

#### COMPASS ROSE

Allows selection of compass direction indication around ship icon. The default is On.



#### BUILT-IN CHARTS

Enables (On) or disables (Off) the Built-In Charts. The default is On.

## 3.9 ABOUT PAGE

From Main Menu page it is possible to select the About page containing Software, Chart and optional devices information.

### ① Software System Information

### ② Cartography Information

### ③ Storage Capacity

CHARTING OPERATING SYSTEM		
Copyright (C) 2007 - 2011.EPPESEN Italia Srl		
Software	X00000X	YYYVY
MODEL	V1710 R (26/06/2008)	
USER	V15410 R (24/03/2008)	
FILE SYSTEM	V3230 R (06/01/2007)	
BUS	V1510 R (28/01/2006)	
GPS	Generic	
FILE/KODOLLE	V1303R (24/03/2008) FF S20	
RADAR/LEKODOLLE	V1200R (20/05/2008) SIMULATION (SH FFFF)	
C-WATER	V10010 R (06/05/2007)	
INTCHART 1 : WW-M012.00 MARINE FRESHWATER WWWR		
BUILT-IN CHARTS	NA-Z010.00	
C-CARD 1	MAN-M032.00 L. ANGELES and S. PEDRO BAYS	
C-CARD 2	NA-C-CARD	
User Points	3000	
Stops	1000	
Track Points	20	
Tracks	20	
MODELARM	Function not activated	
MENU for System Update/Menu		

Figure 3.9 - Example of About page

1. Press **[MENU]**, move the ShuttlePoint knob to highlight **SETUP MENU** and press **[ENT]**.
2. Move the ShuttlePoint knob to highlight **About...** and press **[ENT]** or move the ShuttlePoint knob to the right.
3. The Information page appears on the screen (see the previous Figure).
4. Press **[CLR]** or move the ShuttlePoint knob to the left to exit and show the Chart Page.

## 4. FIND SERVICES

### 4.0 USING FIND SERVICES & MORE FUNCTIONS

The CP590 has a dedicated **[INFO]** key that allows searching the optional C-MAP BY JEPPESEN NT+MAX C-CARD for Port Services, Ports, Tide Stations, Wrecks, Obstructions, Points Of Interest, Lakes, User Points, GPS Coordinates or Information on any point on the Chart.

#### 4.0.0 Port Services

This feature is used to locate Port Services nearest the position of your vessel. The table below shows a list of some of the available Port Services and icons shown on the Chart page:

HEALTH EMERGENCY	HARBOUR MASTER	COAST GUARD	ENGINE REPAIRS	FUEL STATION	WATER	PROVISIONS	CAR PARKING	SEWERAGE PUMP-OU...	PUBLIC TELEGRAPH	PUBLIC RADIO	TRANSPD... SERVICES
ELECTRICITY	POLICE	CUSTOMS... POLICE	BOAT YARD	ACCESSOR... ELECTRON...	ELECTRICAL REPAIRS	COMMERCIAL FISHING SE...	OTHER MARIN...	TOWING SERVICES	PORT PARTNER	BAIT/TACKLE SHOP	OFFICE SERVICE
SAILMAKER	FISHING/DI... GEAR.SCU...	PHARMACY	SLIPWAY	BOAT HOIST	CRANE	NEWSSTAND	CHARTER	LAND BASED VESSEL ST...	AIRPORT	HULL REPAIRS	SPORT ACTIVITY
CHANDLER	BOTTLE GAS	PARKING FOR BO...	YACHT CLUB	HOTEL/INN	RESTAUR...	BOAT RENTAL	FLOODLIT BERTHS	INTERNET POINT	FIRST AID	BOUTIQUE	BAR
BANK/EXC... OFFICE	SHOWERS	LAUNDRE...	PUBLIC TOILETS	PUBLIC TELEPHONE	REFUSE BIN	WATCHING SERVICE	DIVERS	MOORING SERVICE	PROVISION DELIVERY		

Figure 4.0.0 - Port Services Table

1. Press **[INFO]**.
2. Move the ShuttlePoint knob to highlight **PORT SERVICES** and press **[ENT]** or move the ShuttlePoint knob to the right.
3. A popup window will be shown with a list of different Port Services.
4. Move the ShuttlePoint knob to highlight the desired type of service and press **[ENT]**.
5. Another popup window will appear displaying the distance and position of the services closest to your location.
6. Using the ShuttlePoint knob, highlight the desired service and press **[ENT]**. This will show information about the service.

NAME	DIST (nm)	BRG (T)	True	WAAS 3D
AVALON HARBOR	1058	091	True	
AVALON HARBOR	1058	281		
ITHABUS COVE	2040	282		
ITHABUS COVE	2040	292		
BALBOA ISLAND NORTH CHANNEL	2801	04		
BALBOA ISLAND NORTH CHANNEL	2801	04		
DANA POINT HARBOR	2281	67		

**FUEL STATION**  
 OPENING TIME: 0700  
 CLOSING TIME: 1800  
 FUEL TYPE: GASOLINE;DESEL;OLIO;LKO;PETROLIUM;GAS

Figure 4.0.0a - Find Port Services

- Press **[CLR]** to show the actual position of the service on the Chart Page.
- Press **[CLR]** again at any time to return your cursor to your vessel's position.

#### 4.0.1 Port

A Port is represented with a  on the Chart Page. This feature is used to locate the 20 nearest Ports to the position of your vessel.

- Press **[INFO]**.
- Move the ShuttlePoint knob to highlight **PORT** and press **[ENT]** or move the ShuttlePoint knob to the right.
- A popup window will be shown with a list of nearest Ports.
- Move the ShuttlePoint knob to highlight the desired Port and press **[ENT]**.
- Another window will appear displaying the details of the selected Port.



Figure 4.0.1 - Find a Port

- Press **[CLR]** to show the actual position of the Port on the Chart Page.
- Press **[CLR]** again at any time to return your cursor to your vessel's position.

#### 4.0.2 Tide Stations

A Tide Station is represented with a  on the Chart Page. This feature is used to locate the 20 nearest Tide Stations to the position of your vessel. Once a Tide Station is selected the Tide Graph can be used to determine Tide height and draught of the Tide based on a user-specified time.

- Press **[INFO]**.
- Move the ShuttlePoint knob to highlight **TIDE STATIONS** and press **[ENT]** or move the ShuttlePoint knob to the right.
- A popup window will be shown with a list of nearest Tide Stations.
- Move the ShuttlePoint knob to highlight the desired Tide Station and press **[ENT]**.
- Another window will be shown detailing the selected Tide Station information.



Figure 4.0.2 - Find Tide Stations

- Press **[CLR]** to show the actual position of the Tide Station on the Chart Page.
- Press **[CLR]** again at any time to return your cursor to your vessel's position.

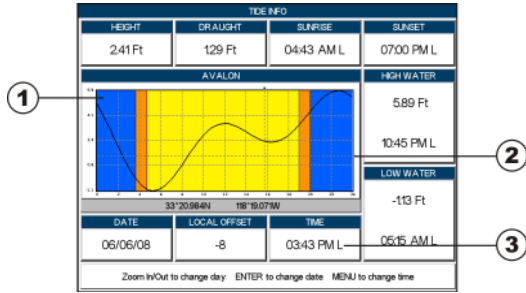

Figure 4.0.2a - Tide Graph page

Refer to the image above. The time (3) displayed corresponds to the location of the cross-hair cursor (2) in the Tide Graph (1). Moving the ShuttlePoint knob to the left or right changes the time, and moving the ShuttlePoint knob up or down selects the Tide height and Tide draught on the Tide Graph.

#### NOTE

The Local Offset matches the Time Offset entered in the Time Setup menu (see Par. 3.2)

### 4.0.3 Wrecks

This feature is used to locate the 20 nearest Wrecks to the position of your vessel. A Wreck is represented with an icon on the chart. See the following table:

ICON	DESCRIPTION
++	non-dangerous wreck
⚠	dangerous wreck
# [FOOT]	distributed remains of wreck
⚠ Mast	wreck showing mast/masts
✈	wreck showing any portion of hull or superstructure

Figure 4.0.3 - Wreck icons table

- Press **[INFO]**.
- Move the ShuttlePoint knob to highlight **WRECKS** and press **[ENT]** or move the ShuttlePoint knob to the right.
- A popup window will be shown with a list of nearest Wrecks.
- Move the ShuttlePoint knob to highlight the desired Wreck and press **[ENT]**.
- Another window will be shown detailing the Wreck information.

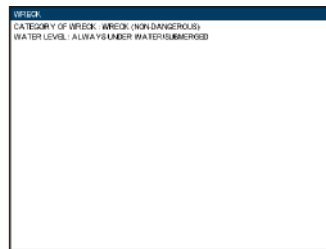
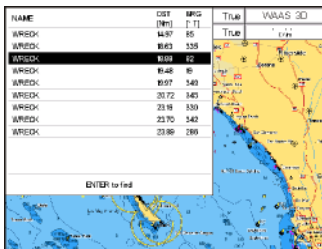

Figure 4.0.3a - Find Wrecks



- Press **[CLR]** to show the actual position of the Wreck on the Chart Page.
- Press **[CLR]** again at any time to return your cursor to your vessel's position.

#### 4.0.4 Obstructions

This feature is used to locate the 20 nearest Obstructions to the position of your vessel. An Obstruction is represented with an icon on the chart, see the following table:

ICON									
DESCR.	snag / stump	wellhead	diffuser	crib	fish haven	foul area	foul ground	ice boom	ground tackle

Figure 4.0.4 - Obstruction icons table

- Press **[INFO]**.
- Move the ShuttlePoint knob to highlight **OBSTRUCTIONS** and press **[ENT]** or move the ShuttlePoint knob to the right.
- A popup window will be shown with a list of nearest Obstructions.
- Move the ShuttlePoint knob to highlight the desired Obstruction and press **[ENT]**.
- Another window will be shown detailing the Obstruction information.

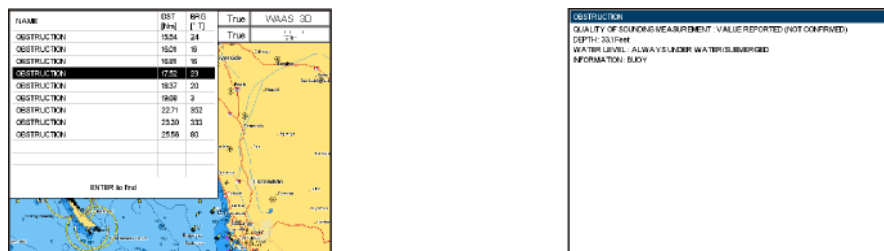

Figure 4.0.4a - Find Obstructions

- Press **[CLR]** to show the actual position of the Obstruction on the Chart page.
- Press **[CLR]** again at any time to return your cursor to your vessel's position.

#### 4.0.5 Lakes Information

A Lake Info is represented with a on the Chart Page. This feature is used to find information on the 20 closest Lakes near the position of your vessel.

##### NOTE

An optional MAX Lake CARD must be inserted into the GPS Chart Plotter to take advantage Lakes Information. The available MAX Lake CARDS are: NA-M017 USA: North; NA-M018 USA: East; NA-M019 USA: South; NA-M020 USA: West; NA-M029: Alaska; NA-M048: Canada.

- Press **[INFO]**.
- Move the ShuttlePoint knob to highlight **LAKES INFORMATION** and press **[ENT]** or move the ShuttlePoint knob to the right.
- A popup window will be shown with a list of Outdoor Recreational Area objects.
- Move the ShuttlePoint knob to highlight the desired object and press **[ENT]**.
- Another popup window will appear displaying the distance and position of the Lakes closest to your location.

- Using the ShuttlePoint knob, highlight the desired Lake and press **[ENT]**. This will show information on the Lake.

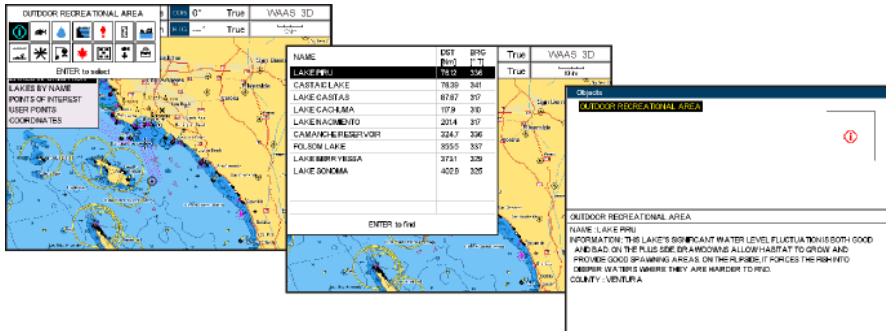

Figure 4.0.5 - Find Lakes Information

- Press **[CLR]** to show the actual position of the Lake on the Chart Page.
- Press **[CLR]** again at any time to return your cursor to your vessel's position.

### Quick Info On Lakes

Upon viewing the chart of a lake, you can click on the Lake Info icon to query the available information immediately displayed with many details. For example, see the following picture:

Lakes Info icon

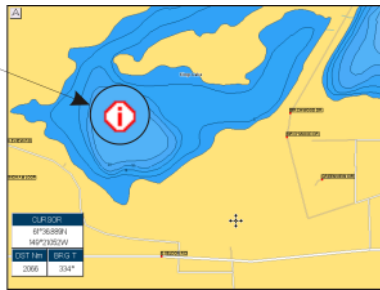

Figure 4.0.5a - Example of Lakes info

When the cursor is placed over the icon, the icons of the available services are shown:



Figure 4.0.5b - Quick Info: available services

If you press **[ENT]** all available information about the cartographic point under the cursor will be shown. See the next paragraph.

## Full Info On Lakes

The following is an example of Full Info on Lakes:

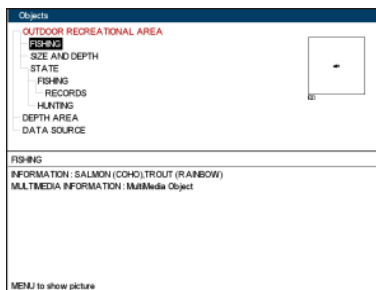

Figure 4.0.5c - Example of Full Info page

To see the "Fishing" object press **[MENU]** (when the "Fishing" object is highlighted). On the screen appears:



Figure 4.0.5d - Example of picture associated to the Fishing object

## 4.0.6 Lakes By Name

This feature is used to locate Lakes By Name nearest the position of your vessel.

1. Press **[INFO]**.
2. Move the ShuttlePoint knob to highlight **LAKES BY NAME** and press **[ENT]** or move the ShuttlePoint knob to the right.
3. A popup window will be shown with a list of nearest Lakes.

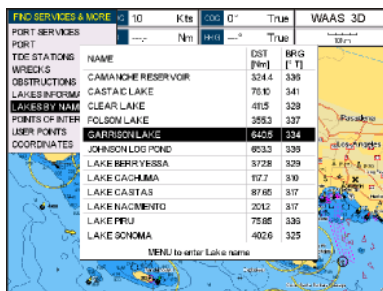

Figure 4.0.6 - Find Lakes By Name

4. Move the ShuttlePoint knob to highlight the desired Lake. Otherwise press **[MENU]** to enter the desired Lake name. A window will be shown: move the ShuttlePoint knob to highlight the edit of Lake name and press **[ENT]** to accept: another popup window will appear displaying the distance and position of the Lake.
5. Press **[ENT]** to show the actual position of the Lake on the Chart Page.
6. Press **[CLR]** again at any time to return your cursor to your vessel's position.

#### 4.0.7 Points Of Interest

This feature is used to locate Points Of Interest nearest the position of your vessel.

1. Press **[INFO]**.
2. Move the ShuttlePoint knob to highlight **POINTS OF INTEREST** and press **[ENT]** or move the ShuttlePoint knob to the right.
3. A (Category) popup window will be shown with a list of Category types (i.e. attractions, emergency, entertainment).
4. Move the ShuttlePoint knob to highlight the desired Category and press **[ENT]**.
5. A (Type) popup window will be shown with a list of types.
6. Move the ShuttlePoint knob to highlight the desired Type and press **[ENT]**.
7. A popup window will be shown with a list of nearest Points Of Interest that fall into the Category and Type you have selected.
8. Move the ShuttlePoint knob up/down to highlight the desired Point Of Interest and press **[ENT]**.
9. Another window will be shown with detailing the Point Of Interest information.

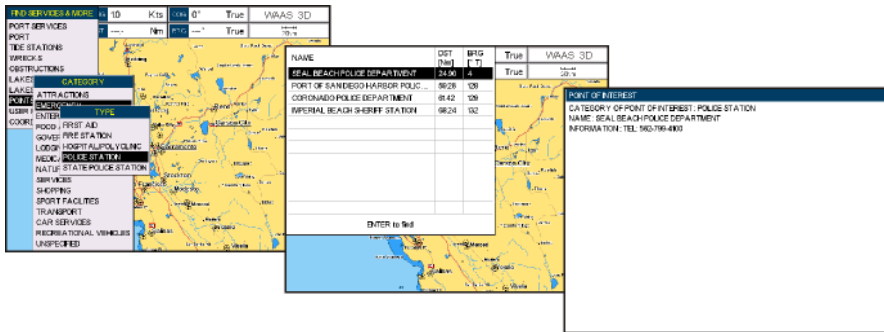

Figure 4.0.7 - Find Points Of Interest

10. Press **[CLR]** to show the actual position of the Point Of Interest on the Chart Page.
11. Press **[CLR]** again at any time to return your cursor to your vessel's position.

#### 4.0.8 User Points

This feature is used to search for User Points (Marks and Waypoints you have created and stored) by name quickly and efficiently.

1. Press **[INFO]**.
2. Move the ShuttlePoint knob to highlight **USER POINTS** and press **[ENT]** or move the ShuttlePoint knob to the right.
3. The (Select Name) popup window will appear. This window will allow you to enter in the name of the User Point you wish to locate.

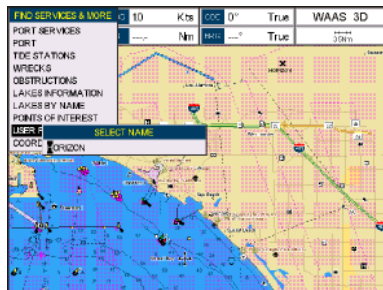

Figure 4.0.8 - Find User Points (Marks and Waypoints)

4. Move the ShuttlePoint knob up/down to change each number or letter and left/right to move to the next or previous position in the name of the Mark.
5. Once the name of the desired Mark reads in the (Select Name) window, press **[ENT]** to show the location the Mark on the Chart Page.
6. Press **[CLR]** at any time to return your cursor to your vessel's position.

#### 4.0.9 Coordinates

This feature allows you to enter Coordinates and view the entered position on the Chart page.

1. Press **[INFO]**.
2. Move the ShuttlePoint knob to highlight **COORDINATES** and press **[ENT]** or move the ShuttlePoint knob to the right.
3. A (Coordinate) popup window will be shown to allow you to enter in a specified Latitude and Longitude.

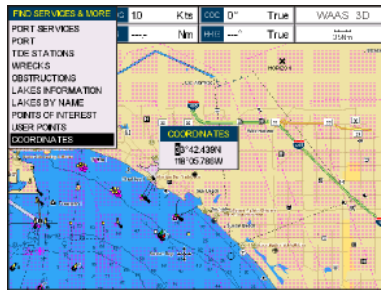

Figure 4.0.9 - Find GPS Coordinates

4. Move the ShuttlePoint knob up/down to change each number or letter and left/right to move to the next or previous position in the Coordinates.
5. Once the Coordinates are entered, press **[ENT]** to show the location the Mark on the Chart Page.
6. Press **[CLR]** at any time to return your cursor to your vessel's position.

#### 4.0.10 Information

This feature allows you to obtain information on any position on the Chart Page.

1. Press **[INFO]**.
2. Move the ShuttlePoint knob to highlight **INFORMATION** and press **[ENT]** or move the ShuttlePoint knob to the right.
3. A page will be shown with objects information. The upper side of the page contains the Info Tree and the lower side contains the expanded information. While moving the ShuttlePoint knob through the Info Tree, all the relevant information of the selected object is shown on the lower part of the page.
4. Press **[CLR]** again at any time to return your cursor to your vessel's position.

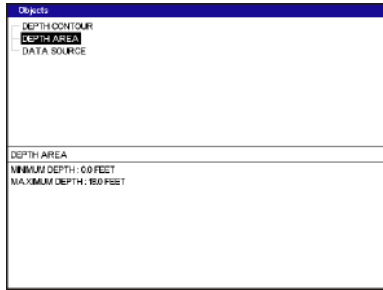

Figure 4.0.10 - Find Information

---

## 5. MAX CARTOGRAPHY OVERVIEW

---

### 5.0 BUILT-IN CHARTS

---

#### 5.0.0 Coverage areas and details

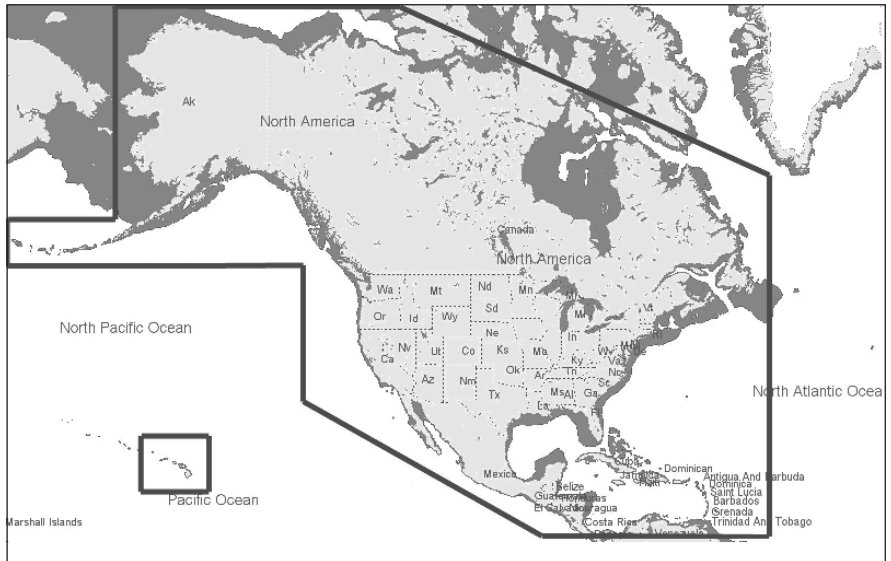

Figure 5.0.1 - Coverage Area

The CP590 has Built-In Charts for coastal navigation of USA including Alaska, Hawaii and Great Lakes, Canada, Bahamas, Caribbean, Cuba, Puerto Rico, and Central America which include:

- a. Depth contours and spot soundings to 66 Ft (20 meter) on lower scale charts and 33 Ft (10 meters) on higher scale charts
- b. All nav-aids with icon
- c. Tidal diamond symbols on Chart Page
1. Marina symbol with name and the list of services symbols

#### 5.0.1 Updating Built-In Charts

The Built-In Charts can be updated by purchasing a Chart Update CARD from your local marine electronics dealer or C-MAP USA at (800) 424-2627.

This Chart Update CARD may be used ONE time to update the charts in a GPS Chart Plotter.

After the updating, the Chart Update CARD will not update other GPS Chart Plotters.

After purchasing the Chart Update CARD, follow the procedure below to update the charts.

1. Turn Off the GPS Chart Plotter.
2. Insert the Chart Update CARD into the slot.
3. Press and hold **[PWR]** to turn the GPS Chart Plotter On.
4. The GPS Chart Plotter's display will show a message that the Built-In Charts are being uploaded.
5. After uploading the GPS Chart Plotter will check to ensure the charts have been loaded correctly and show a message.

#### NOTE

If the message shows the charts were not updated correctly, follow steps 1-4 again. If the GPS Chart Plotter shows a error message again, contact C-MAP USA at (800) 424-2627 for assistance.

## 5.1 INSERTING THE OPTIONAL MAX C-CARD

Hold the C-CARD by the long inclined side so that you can see the C-MAP BY JEPPESEN label. Open the door, gently push the C-CARD into the slot: push the C-CARD in as far as it will go, then close the door.

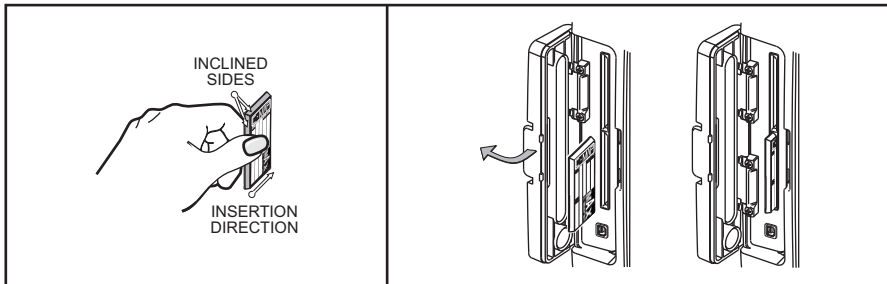

Figure 5.1 - Inserting C-CARD

#### NOTE

The small connector below the C-CARD is only used by Standard Horizon repair technicians.

Key points are:

### Data Features

- **ISO Certification** (*electronic chart production process with quality certification*)
- **Extra Large Coverage** (*all the C-MAP electronic chart detail and a huge coverage without having to change cartridge*)
- **Official data source** (*data based on use of official data sources Hydrographic Offices Release*)
- **Detailed World Background** (*worldwide background chart with details*)
- **Depths & Land Elevation** (*color shading of sea depth and land altitude for improved chart appearance*)
- **Bathymetric & Spot Soundings** (*Data Base with depth and bathy information for an*



- extraordinary view of the seabed depth)*
- **Detailed Port Plan to information** (*complete port and marina charts with detail*)
- **Search & Find** (*quickly locates chart contents and objects*)
- **Tides Preview** (*allows viewing of current, future and past tide cycles of specific NOAA Tide Stations*)
- **Dynamic Currents** (*current arrows showing speed and direction of current, future and past currents*)
- **Dynamic Nav-Aids** (*selection to enable the Nav-Aids to blink to their specifications and appear on the chart in color*)
- **Port Info** (*searchable data base of service in ports*)
- **Enhanced Port Info & Roads** (*searchable data base of detailed information that include facilities and services in ports and surrounding areas*)
- **Object Info** (*moving cursor over object to show restricted area details and related information*)
- **Quick Info** (*moving cursor over wrecks, shoals, Nav-Aids to show restricted area details and related information and object to show details*)
- **Photos & Diagrams** (*high definition pictures of ports, piers, bridge diagrams and nav-aids*)
- **Multilanguage Support** (*allows the plotter to show language of your choice in using proper character set for Asian and other countries*)
- **True-Type Font** (*improves text on chart for optimal reading*)

### **Presentation Features**

- **Clear View** (*advanced legibility techniques providing more chart data on the screen*)
- **Clear Info** (*sophisticated "Human Dictionary" to translate Nav-Aid abbreviations found on paper charts*)
- **Flexi-Zoom** (*increased Under and Over Zoom between chart levels, resulting in optimal scale display for any situation*)
- **Perspective View** (*"Real World" perspective view of the chart, updated real-time during navigation*)
- **Enhanced Mixing Levels** (*seamless data presentation*)
- **Off-line redraw** (*cartography level transition without image construction*)

### **Cartographic Data related Features**

- **Guardian Alarm** (*the Guardian Alarm is a user defined area in front of your vessel to alert you while navigating of possible obstacles on the chart*)
- **Safety Status Bar** (*a status bar with six boxes to show the status of certain functions. Any warning or alarm condition is identified by the red color to indicate possible risk*)
- **Safety Route Check** (*sophisticated function that checks for dangerous objects along your navigation route*)

### **MAX and NT/NT+ C-CARD coexistence**

- When NT+ data and MAX data cover different areas, the GPS Chart Plotter receives data from both charts (depending on the current position).
- When NT+ data and MAX data cover the same area, the GPS Chart Plotter receives data only from MAX chart.

# 6. CHART FUNCTIONS

## 6.0 MAX FUNCTIONS MENU

1. Press **[MENU]**, move the ShuttlePoint knob to highlight **SETUP MENU** and press **[ENT]**.
2. Move the ShuttlePoint knob to highlight **MAX FUNCTIONS** and press **[ENT]** or move the ShuttlePoint knob to the right. The MAX Functions menu appears on the screen:

MAX FUNCTIONS	
ZOOM TYPE	Standard
ICONS SIZE	Standard
PLACE NAMES SIZE	Standard
PERSPECTIVE VIEW	Off
DYNAMIC NAV-AIDS	On
SAFETY STATUS BAR	Off
SATELLITE IMAGERY	On
CURRENTS PREDICTION	
CHART LANGUAGE	

Figure 6.0 - Max Functions Menu

The available Max Functions menu is described in the following.

### 6.0.0 Zoom Type

Zoom Type refers to the chart scale selection. It has two options: Standard (default) or Flexi-Zoom. When Zoom Type is set to Flexi-Zoom, a short **[ZOOM IN]/[ZOOM OUT]** push causes a change of chart level, while a long **[ZOOM IN]/[ZOOM OUT]** push (press and hold) causes an expansion or compression of the chart image, without a chart level change.

CHART: US,NOS,GRAPH,11472H  
SCALE: 1:40000

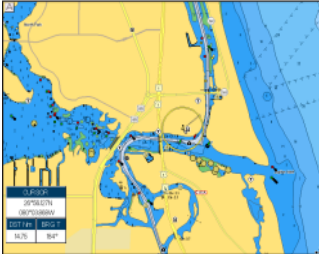

LONG PUSH **ZOOM OUT**

CHART: US,NOS,GRAPH,11472H  
SCALE: 1:40000



SHORT PUSH **ZOOM OUT**

CHART: US,NOS,GRAPH,11474  
SCALE: 1:80000

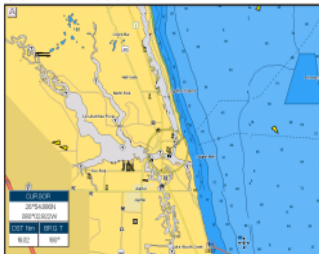

Figure 6.0.0 - Zoom Type

Note that in the top of the previous picture the chart scale remains the same but it is graphically compressed.

By pressing **[ZOOM IN]/[ZOOM OUT]** a popup window is displayed on a corner of the chart screen. The window shows the current zoom factor: Normal is the original chart level (1:1 scale), Over-Zoom x2, x4, x16, x32, Under-Zoom x1/2, x1/4.

To activate this function follow the procedure:

1. Press **[MENU]**, move the ShuttlePoint knob to highlight **SETUP MENU** and press **[ENT]**.
2. Move the ShuttlePoint knob to highlight **MAX FUNCTIONS** and press **[ENT]** or move the ShuttlePoint knob to the right.
3. Move the ShuttlePoint knob to highlight **ZOOM TYPE** and press **[ENT]** or move the ShuttlePoint knob to the right.
4. The menu now shows two selections, **STANDARD** or **FLEXI-ZOOM**.
5. Move the ShuttlePoint knob to select the selection and press **[ENT]**.
6. Press **[CLR]** until the menu disappears or an easier method is to move the ShuttlePoint knob to the left a few times.

### 6.0.1 Icon Size

On MAX charts it is possible to set the size of all icons drawn on the charts, selecting between Standard (default) and Large size.

ICONS SIZE standard



ICONS SIZE large



Figure 6.0.1 - Icons Size

To activate this function follow the procedure:

1. Press **[MENU]**, move the ShuttlePoint knob to highlight **SETUP MENU** and press **[ENT]**.
2. Move the ShuttlePoint knob to highlight **MAX FUNCTIONS** and press **[ENT]** or move the ShuttlePoint knob to the right.
3. Move the ShuttlePoint knob to highlight **ICONS SIZE** and press **[ENT]** or move the ShuttlePoint knob to the right.
4. The menu now shows two selections, **STANDARD** or **LARGE**.
5. Move the ShuttlePoint knob to select the selection and press **[ENT]**.
6. Press **[CLR]** until the menu disappears or an easier method is to move the ShuttlePoint knob to the left a few times.

### 6.0.2 Place Name Size

On MAX charts it is possible to set the size of all names drawn on the charts, selecting between Standard (default), Medium and Large size.

PLACE NAMES SIZE standard



PLACE NAMES SIZE medium



PLACE NAMES SIZE large



Figure 6.0.2 - Place Names Size

To activate this function follow the procedure:

1. Press **[MENU]**, move the ShuttlePoint knob to highlight **SETUP MENU** and press **[ENT]**.
2. Move the ShuttlePoint knob to highlight **MAX FUNCTIONS** and press **[ENT]** or move the ShuttlePoint knob to the right.
3. Move the ShuttlePoint knob to highlight **PLACE NAMES SIZE** and press **[ENT]** or move the ShuttlePoint knob to the right.
4. The menu now shows three selections, **STANDARD**, **MEDIUM** or **LARGE**.
5. Move the ShuttlePoint knob to select the selection and press **[ENT]**.
6. Press **[CLR]** until the menu disappears or an easier method is to move the ShuttlePoint knob to the left a few times.

### 6.0.3 Perspective View

The Chart page may be show in a perspective (fly over) or normal mode during navigation. Perspective view of the chart is a type of “bird’s eye” view of a chart, and give you a more realistic perspective of the chart. As the upper side of the chart is more compressed than the lower side, a wider chart area is visible, so it allows showing more chart information immediately ahead and around the cursor.

Perspective View ON

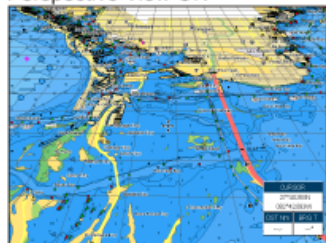

Perspective View OFF



Figure 6.0.3 - Perspective View

To activate this function follow the procedure:

1. Press **[MENU]**, move the ShuttlePoint knob to highlight **SETUP MENU** and press **[ENT]**.
2. Move the ShuttlePoint knob to highlight **MAX FUNCTIONS** and press **[ENT]** or move the ShuttlePoint knob to the right.
3. Move the ShuttlePoint knob to highlight **PERSPECTIVE VIEW** and press **[ENT]** or move the ShuttlePoint knob to the right.
4. The menu now shows two selections, **ON** or **OFF**.
5. Move the ShuttlePoint knob to select the selection and press **[ENT]**.
6. Press **[CLR]** until the menu disappears or an easier method is to move the ShuttlePoint knob to the left until the Chart page is shown.

## 6.0.4 Dynamic Nav-Aids

This function allows the blinking of the Nav-Aids to be turned On or Off. The blink period and color of each Nav-aid is read from the Nav-Aid attributes stored on the optional C-MAP By JEPPESEN C-CARD. When the ship is inside the Nav-Aid nominal range, the light of the Nav-Aid will start blinking. When Dynamic Nav-Aids option is set to On, when the flashing light is Off, or when fix position is out of the sector, the light color is displayed by using a faint light color. To activate this function follow the procedure below:

1. Press **[MENU]**, move the ShuttlePoint knob to highlight **SETUP MENU** and press **[ENT]**.
2. Move the ShuttlePoint knob to highlight **MAX FUNCTIONS** and press **[ENT]** or move the ShuttlePoint knob to the right.
3. Move the ShuttlePoint knob to highlight **DYNAMIC NAV-AIDS** and press **[ENT]** or move the ShuttlePoint knob to the right.
4. The menu now shows two selections, **ON** or **OFF**.
5. Move the ShuttlePoint knob to select the selection and press **[ENT]**.
6. Press **[CLR]** until the menu disappears or an easier method is to move the ShuttlePoint knob to the left until the chart page is shown.

## 6.0.5 Safety Status Bar (DSI - Data Safety Indicator)

When the Safety Status Bar is enabled, a status bar with six boxes show the status of certain functions. Any warning or alarm condition is identified by the red color to indicate possible risk.

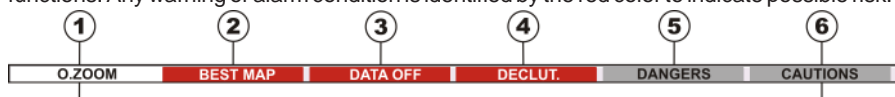

- ① **Normal:** when the chart is displayed at normal scale.

**U. Zoom:** red when the chart is under-zoomed out more than twice normal scale, gray otherwise.

**O. Zoom:** red when the chart is over-zoomed in more than twice normal scale, gray otherwise.

**No Chart:** red when the chart is zoomed in more than twice normal scale, gray otherwise.

- ② Red when a more detailed chart is available under the cursor position.
- ③ Red when at least one of the following objects or layers is turned off (by the user) Depths/soundings; Wrecks/obstructions; Tracks/routes; Attention Areas; Nav-Aids.
- ④ Displays red when clearing overlapping objects.
- ⑤ Red when "Guardian Technology" detects one of the following objects: Land, Intertidal, Depth Area, Rocks, Obstructions, Shoreline Constructions, Fishing Facility, Wrecks, Dragged area, Diffusion area, Mooring facilities, Pingos and Production installations.
- ⑥ Red when "Guardian Technology" detects cautionary or restricted area.

Safety Status Bar



Figure 6.0.5 - Safety Status Bar

To activate this function follow the procedure:

1. Press **[MENU]**, move the ShuttlePoint knob to highlight **SETUP MENU** and press **[ENT]**.
2. Move the ShuttlePoint knob to highlight **MAX FUNCTIONS** and press **[ENT]** or move the ShuttlePoint knob to the right.

3. Move the ShuttlePoint knob to highlight **SAFETY STATUS BAR** and press **[ENT]** or move the ShuttlePoint knob to the right.
4. The menu now shows the following selections:  
**ON**: The Safety Status Bar is shown  
**OFF**: The Safety Status Bar is not shown  
**ICON**: In this mode the Safety Status Bar is not shown, rather a Warning Icon  will be shown in the top right corner on the Chart page when an alarm condition is met.

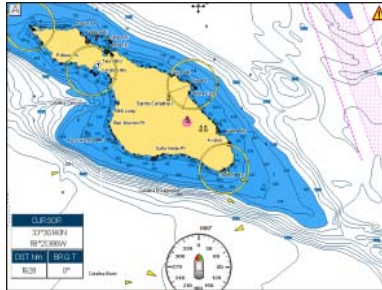

Figure 6.0.5a - Example of Chart page with Warning Icon displayed

5. Move the ShuttlePoint knob to select the selection and press **[ENT]**.
6. Press **[CLR]** until the menu disappears or an easier method is to press the ShuttlePoint knob to the left a few times.

## 6.0.6 Satellite Imagery

This function allows to overlay the Satellite image for background chart. When it is set On, the Palette is set to Normal to display the proper colors. To activate this function follow the procedure below:

1. Press **[MENU]**, move the ShuttlePoint knob to highlight **SETUP MENU** and press **[ENT]**.
2. Move the ShuttlePoint knob to highlight **MAX FUNCTIONS** and press **[ENT]** or move the ShuttlePoint knob to the right.
3. Move the ShuttlePoint knob to highlight **SATELLITE IMAGERY** and press **[ENT]** or move the ShuttlePoint knob to the right.
4. The menu now shows two selections, **ON** or **OFF**.
5. Move the ShuttlePoint knob to select the selection and press **[ENT]**.
6. Press **[CLR]** until the menu disappears or an easier method is to move the ShuttlePoint knob to the left until the Chart page is shown.



Figure 6.0.6 - Example of Satellite Imagery

## NOTE

The satellite image is only shown on 100Nm, 50Nm and 20Nm scales.

### 6.0.7 Currents Prediction

The worldwide database with tidal stream information is available with MAX C-CARDS. When data/time is available, Tidal stream arrows are shown on the charts, indicating the direction and strength of the Tide:



Figure 6.0.7 - Tidal stream arrows

If no data/time is available from the GPS or the GPS Chart Plotter is not in Simulation mode, the icon on the chart is generic one. The color of the arrow denotes the strength of the current as follows:

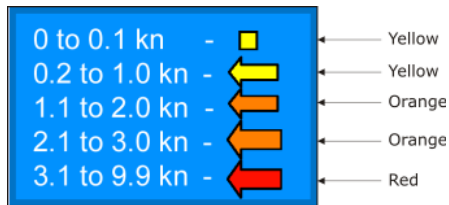

Figure 6.0.7a - Tidal stream arrows table

When the GPS Chart Plotter receives a valid position fix, the Tide icons are shown on the charts on the basis of the current date and time: the screen displays and changes arrows as date/time changes.

To activate this function follow the procedure:

1. Press **[MENU]**, move the ShuttlePoint knob to highlight **SETUP MENU** and press **[ENT]**.
2. Move the ShuttlePoint knob to highlight **MAX FUNCTIONS** and press **[ENT]** or move the ShuttlePoint knob to the right.
3. Move the ShuttlePoint knob to highlight **CURRENTS PREDICTION** and press **[ENT]** or move the ShuttlePoint knob to the right.
4. A window is shown on the high-left side of the chart.
5. Press **[INCR. TIME]** to increase the time in 30 minute increments.  
Press **[DECR. TIME]** to decrease the time in 30 minute increments.  
Press **[SET TIME]** to change the date and time manually.
  - a. Press Alphanumeric key or move the ShuttlePoint knob up or down to select the number in the date.
  - b. To select the next number in the Date field, move the ShuttlePoint knob to the right and repeat step a. until the date is shown.
  - c. To store the date press **[ENT]** and the Time will be selected.
  - d. Press Alphanumeric key or move the ShuttlePoint knob up or down to select the number in the Time.

- e. To select the next number in the Time field, move the ShuttlePoint knob to the right and repeat step a. until the time is shown.
  - f. To store the Time, press **[ENT]** and Speed (SPD) and Direction (DIR) will be updated in the table.
6. Press **[Exit]**.

### 6.0.8 Chart Language

The CP590 may be customized to show the local language of the chart. To select the Chart Language you want:

1. Press **[MENU]**, move the ShuttlePoint knob to highlight **SETUP MENU** and press **[ENT]**.
2. Move the ShuttlePoint knob to highlight **MAX FUNCTIONS** and press **[ENT]** or move the ShuttlePoint knob to the right.
3. Move the ShuttlePoint knob to highlight **CHART LANGUAGE** and press **[ENT]** or move the ShuttlePoint knob to the right. A new popup window will appear on the screen. The available functions are described in the table below.

<b>Language</b>	: Allows setting the language to display chart information. The language is chosen among the list of languages available on the cartographic data (data cartridge or embedded charts).
<b>Mode</b>	: Defines how objects are translated. Selections are: <ul style="list-style-type: none"> <li>Off : Enables the language chosen in the Language menu above. If the selected language is not present on the objects information, English is used.</li> <li>English: Always uses English.</li> <li>Local : Uses the Local language present on C-MAP BY JEPPESEN C-CARD. If no Local language is available, English is used.</li> </ul>

4. After the selection is made, press **[CLR]** repeatedly or move the ShuttlePoint knob to the left repeatedly until the Chart page is shown.

#### NOTE

- a. When the Chart Language is changed, the following settings are automatically selected: MODE is set to Off and Chart Language is set to your selection.
- b. If the C-CARD is removed or changed, the Chart Language should be confirmed and changed if necessary.

### 6.0.9 Pictures or Diagrams

Using optional C-MAP BY JEPPESEN MAX data cards allows you to show pictures or diagrams on the CP590 display. These *Pictures* are typically used to facilitate the identification of cartographic objects or places around the chart: they can be the landscape layout nearby a harbour, the shape of a bridge or of a buoy etc. On some objects, such as bridges, the image associated can represent the *Diagram* representing the shape of the objects and the various characteristics (length, height, type of bridge etc.).

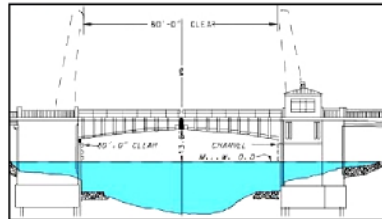



Figure 6.0.9 - Pictures & Diagrams



## How to show the Pictures or Diagrams of a Object

They are shown on the Chart page with the camera icon , see the following figure:

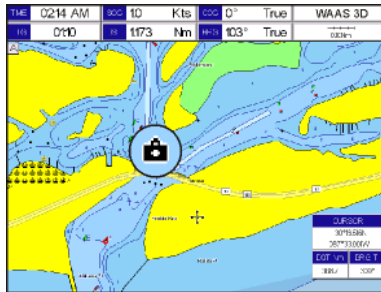

Figure 6.0.9a - Example of camera icon

Move the cursor over the camera icon. You are get the quick info on the object and there is the camera icon on the top bar of the window:

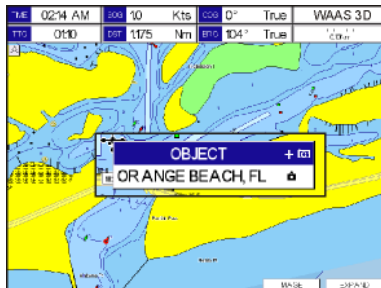

Figure 6.0.9b - Example of Quick Info on camera icon

Press **[IMAGE]** to display the image on the screen:



Figure 6.0.9c - Example of displayed image

Otherwise press **[EXPAND]** to open the Full Info on the object. Note that on the Full Info, there is the small camera icon on a corner of the square containing the object icon. To see the picture press **[MENU]** when the object with a picture is highlighted.

When the picture is shown, it is possible to fit it to screen by pressing **[ENT]**, to change the contrast by pressing **[ZOOM IN]** or **[ZOOM OUT]** and to display the next picture associated,

if any, by moving the ShuttlePoint knob left or right.

### 6.0.10 Enhanced Port Info

Optional C-MAP BY JEPPESEN MAX C-Cards include additional Port Services that were not present before. Additional attributes of Port Areas and Port Marinas have been included as Location, Country, Region, State, Harbour master telephone number etc., see the following figure.

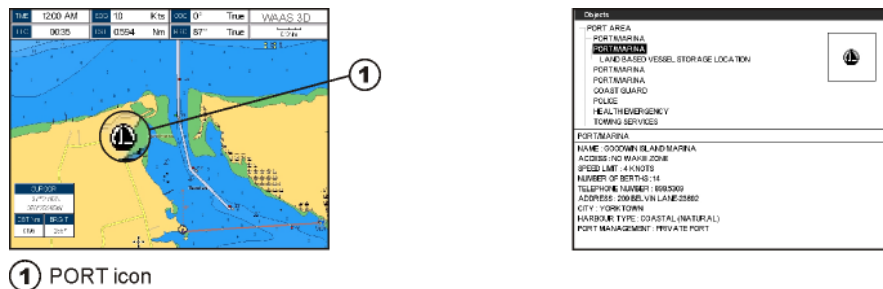

Figure 6.0.10 - Example of enhanced Port Info

---

## 7. CREATING MARKS

---

Definitions:

**MARK**

Can be a stand alone position or be linked to a Route. A Mark is placed on the Chart Page using the **[MARK]** key or by entering in information in the **MARK/WAYPOINTS** menu and selecting **NEW MARK**.

**WAYPOINT**

is linked to a Route and placed on the Chart page using the **[ROUTE]** key.

---

NOTE

The difference between a Mark and a Waypoint is

- When a Route is created using WAYPOINTS and the ROUTE is deleted the WAYPOINTS are also deleted.
  - If a Route is created using MARKS and the ROUTE is deleted the MARKS remain.
- 

---

### 7.0 CREATING A NEW MARK USING THE CHART PAGE

---

- Move the ShuttlePoint knob to the desired or approx. Lat/Lon and press **[MARK]**.
- You will notice a Mark is placed under the location of the Cursor and a popup window is shown with the exact Lat/Lon of the Mark.
- If the position is incorrect, pressing **[EDIT]** allows changing of the position, Mark name and icon type. Refer to Par. 7.1 for details.

- 1 Mark placed under Cursor
- 2 Lat/Lon of Mark, DST/BRG from vessel location
- 3 Press Soft Key to show the Marks/Waypoint List, to edit, to move or to delete Mark
- 4 Vessel location



Figure 7.0 - Mark creation

---

NOTE

After entering in all the Marks it is a good practice to back up the points to an User C-CARD. Refer to Section 11.

---

---

### 7.1 EDITING A MARK

---

If a Mark has previously been created and you wish to Edit it, move cursor over the top of the Mark.

- After a Mark is created press **[EDIT]** to show the edit popup window.



Figure 7.1 - Mark editing

- The Mark Icon is selected, press **[ENT]**. A popup window appears:



Figure 7.1a - Mark Icons

- Move the ShuttlePoint knob to select the desired Mark Icon, when finished press **[ENT]**.
- Move the ShuttlePoint knob to the right to select the Mark Name. Press **[ENT]** and the first digit in the name will be highlighted.
- Move the ShuttlePoint knob up or down to select the first character.
- Move the ShuttlePoint knob to the right to select the next character.
- Repeat steps 4 and 5 until the Mark name is shown. Press **[ENT]**.
- Move the ShuttlePoint knob to the right to select the Lat/Lon and press **[ENT]**.
- Move the ShuttlePoint knob up or down to select the first character.
- Move the ShuttlePoint knob to the right to select the next character.
- Repeat steps 9 and 10 until the desired position is shown. Press **[ENT]** and **[CLR]** to store the Mark.

### 7.1.0 Deleting a Mark or Waypoint

- Move the ShuttlePoint knob over the Mark or Waypoint to delete.
- Press **[DELETE]**. A popup window will be shown to confirm deleting the point.
- Move the ShuttlePoint knob to highlight **YES** and press **[ENT]**.

### 7.1.1 Moving a Mark or Waypoint

- Move the ShuttlePoint knob over the Mark or Waypoint you want to move.
- Press **[MOVE]**.
- Use the ShuttlePoint knob to move the cursor. A dotted line, connecting the previous Waypoint position to the new position, is shown:



Figure 7.1.1 - Moving Mark or Waypoint (I)

4. Press **[ENT]** (**[CLR]** to abort the move), the Waypoint appears in the new position.



Figure 7.1.1a - Moving Mark or Waypoint (II)

## 7.2 MARKS/WAYPOINTS LIST

The **MARKS/WPTS** List shows all the Marks and Waypoints that have been stored into the CP590. To obtain the List page:

1. Created a Mark.
2. Place the cursor over the Mark, press **[List]**.

This page also allows you to:

<b>ICON</b>	Sorts by icon type. Selections are: <ol style="list-style-type: none"> <li>a. <b>SELECT</b> : only User Points with the selected icon are shown</li> <li>b. <b>ALL</b> : all User Points are shown</li> </ol>
<b>FIND</b>	Searches through the Marks or Waypoints to find a point by name using the ShuttlePoint knob.
<b>LOCATE</b>	Shows the position of a Mark or Waypoint on the Chart page.
<b>EDIT</b>	Edits a previous stored Mark or Waypoint.
<b>NEW MARK</b>	Enters in Marks, editing icon type and position.
<b>MODE</b>	Controls how the Marks or Waypoints are shown on the Chart page. Selections are: <ol style="list-style-type: none"> <li>a. <b>SHOW</b> : icon and name are shown</li> <li>b. <b>ICON</b> : only icon (no name) is shown</li> <li>c. <b>HIDE</b> : Mark or Waypoint is hidden</li> <li>d. <b>SHOW ALL</b> : all Marks or Waypoints are shown</li> <li>e. <b>ICON ALL</b> : all icons are shown without name</li> <li>f. <b>HIDE ALL</b> : all Marks or Waypoints are hidden</li> </ol>
<b>DELETE</b>	Deletes the selected point.
<b>DEL ALL</b>	Deletes all stored points.
<b>SORT</b>	Sorts the name of User Points. Selections are: <ol style="list-style-type: none"> <li>a. <b>A-Z ASCENDING</b> : sorts the name of the Mark or Waypoint in ascending order</li> <li>b. <b>Z-A DESCENDING</b> : sorts the name of the Mark or Waypoint in descending order</li> </ol>

<b>SEND</b>	Sends the stored points to an external device (PC) capable of listening to NMEA WPL and RTE sentences.
<b>RECEIVE</b>	Receives points from an external device (PC) that is capable of sending NMEA WPL sentence.

### NOTE

The SEND and RECEIVE functions are usually used by navigation programs running on a PC.

SYM	NAME	TYPE	LATITUDE	LONGITUDE	DISTANCE	MODE
	HORIZON	MARK	30°48.338N	120°02.26W	280	SHOW
	MRK002	MARK	31°48.02N	074°28.754W	89°	SHOW
	MRK005	MARK	30°48.48N	073°02.43W	307	SHOW
	MRK007	MARK	31°22.528N	073°50.433W	408	SHOW
	WPT003	WPT	34°30.00N	012°02.00W	100	SHOW
	WPT004	WPT	34°38.048N	012°02.800W	102	SHOW
	WPT005	WPT	36°10.00N	073°50.433W	177	SHOW

Figure 7.2 - Example of Marks/Waypoints List

## 7.3 CREATING/MODIFY A NEW MARK IN THE USER POINTS LIST

### NOTE

This function is very useful if you have a list of Marks that you want to enter into the GPS Chart Plotter.

1. Press **[MENU]**, move the ShuttlePoint knob to highlight **USER POINTS** and press **[ENT]**.
2. Move the ShuttlePoint knob to highlight **MARKS/WPTS** and press **[ENT]**.
3. The MARKS/WAYPOINTS List page will be shown (see previous Figure).
4. To create a New Mark, move the ShuttlePoint knob to the right to highlight **NEW MARK** and press **[ENT]**. A row is added for the new Mark.
5. Move the ShuttlePoint knob to highlight **EDIT** and press **[ENT]**; then press **[ENT]** again to display a popup icons window and change the icon.
6. Move the ShuttlePoint knob to highlight the desired Icon and press **[ENT]**.
7. Move the ShuttlePoint knob to the right to select the Mark name. Press **[ENT]** and the first digit in the name will be highlighted.
8. Move the ShuttlePoint knob up or down to select the first character.
9. Move the ShuttlePoint knob to the right to select the next character.
10. Repeat steps 8 and 9 until the Mark name is shown. Press **[ENT]**.
11. Move the ShuttlePoint knob to the right to select the Lat/Lon and press **[ENT]**.
12. Move the ShuttlePoint knob up or down to select the first character.
13. Move the ShuttlePoint knob to the right to select the next character.
14. Repeat steps 12 and 13 until the desired position is shown. Press **[ENT]**.
15. Move the ShuttlePoint knob to the right to select the Mode field and press **[ENT]**.
16. Move the ShuttlePoint knob up or down to select the mode to show the Mark. You can choose among SHOW to show on the chart the name and icon of Mark, ICON to show on the chart only the icon of Mark or HIDE to hide on the Chart page the created Mark. Press **[ENT]**.
17. Press **[CLR]** to save the created Mark.
18. Press **[CLR]** again and the new Mark appears on the Chart page.

### NOTE

After entering in all the Marks it is a good practice to back up the points to a C-CARD. Refer to Section 11.

## 7.4 GOTO CURSOR, ROUTE AND MARK

The GPS Chart Plotter can easily be set to start navigating to the Cursor on the chart page, a saved Mark or a Route that was created.

### GOTO CURSOR

1. Move the ShuttlePoint knob to the exact position you want to navigate to.
2. Press [**GOTO**] and a GOTO popup window will be shown.



Figure 7.4 - GO TO menu (1)

3. Move the ShuttlePoint knob to highlight **CURSOR** and press [**ENT**].



Figure 7.4a - GO TO menu (2)

4. The GPS Chart Plotter is now navigating from your current position to the location selected at step 1. A bearing line between the vessels location and the destination point is shown. A popup window shows the Distance (DST) and Bearing (BRG) from the vessels location to the destination point.

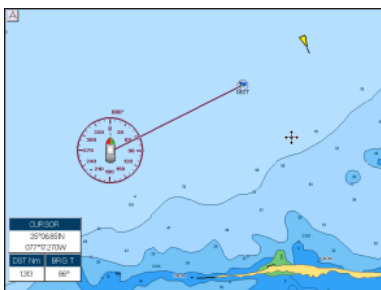

Figure 7.4b - GO TO menu (3)

5. The GPS Chart Plotter is in Cursor mode, to switch to Home mode press **[CLR]** so the vessel will stay in the center of the page.
6. Two Soft Keys are also shown that allow you to quickly switch to the HIGHWAY page or to stop navigation.
7. To STOP Navigation, press **[GOTO]** and a WARNING window is shown. Move the ShuttlePoint knob to highlight **STOP** and press **[ENT]**.



Figure 7.4c - Warning window

## GOTO ROUTE

When a Route is shown on the Chart page, move the cursor over the designed Waypoint and press **[GOTO]**. For more information about Routes refer to Section 9.

## GOTO MARK

1. Move the ShuttlePoint knob to an open position (no buoy, warning etc. under the cursor) on the Chart page.
2. Press **[GOTO]** to show the GOTO popup window.
3. Move the ShuttlePoint knob to highlight **MARK** and press **[ENT]** to show the MARKS/WAYPOINTS List.
4. Move the ShuttlePoint to highlight the desired Mark or Waypoint and press **[GOTO]**.
5. You will notice a circle is drawn around the Icon Symbol. This means the GPS Chart Plotter is now navigating to the point.
6. Press **[CLR]** to switch to the Chart Page or Highway Page to start navigating to the point.



---

## 8. MAN OVER BOARD (MOB) FUNCTION

---

During navigation, the MOB feature provides a one-touch method of storing a location, such as a point where a crew member fell overboard. In this mode, the GPS Chart Plotter places a MOB point on the Chart page and all the navigation data shown is related to navigating back to this point, allowing you to retrace your path to the MOB point efficiently.

### 8.0 PLACING A MOB POINT

---

1. On the Chart page, press **[MOB]** to start navigating back to the point. Press **[CLR]**.
2. You will notice a MOB Mark will be on the Chart page and all navigation is referring back to this point.

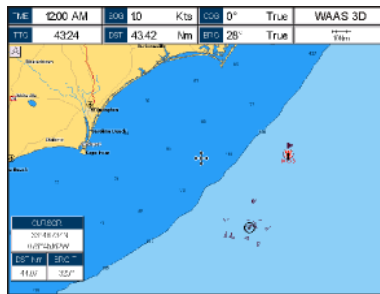

Figure 8.0 - MOB point

3. If the cursor is moved over the MOB Icon, the popup windows over Soft Keys will be shown allowing quick access to the Highway or Navigation page, or to Route Check.
4. To stop navigating to the MOB point, press **[GOTO]**, select **STOP** and press **[ENT]**.

### 8.1 DELETING A MOB POINT

---

1. Move the ShuttlePoint knob until the cursor is over the top of the MOB icon.

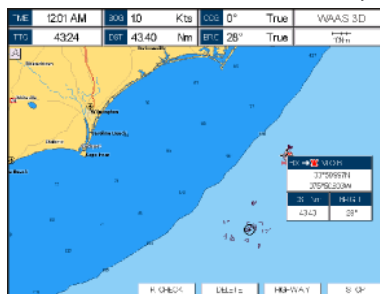

Figure 8.1 - Deleting MOB point

2. Press **[DELETE]**.
3. A popup window will be shown to confirm deleting the MOB point. Move the ShuttlePoint knob to highlight **YES** and press **[ENT]**.

## 9. ROUTES

The CP590 has the capability to store 50 Routes with 100 Waypoints or Marks in each Route. A Route can consist of Waypoints or Marks. The difference is when a Route is made using Waypoints and the Route is deleted the Waypoints are also deleted. However if a Route is made of Marks and the Route is deleted the Marks stay in memory.

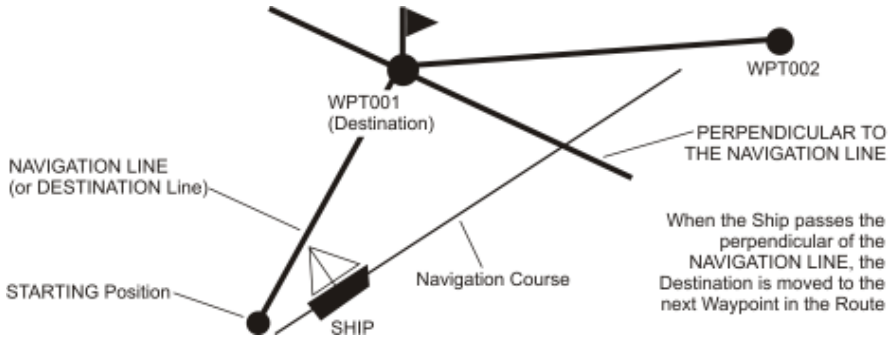

Figure 9 - Example to show how the plotter switches from one Waypoint to another

### 9.0 CREATING A ROUTE USING WAYPOINTS

1. On the Chart page move the ShuttlePoint knob to the Lat/Lon of the starting Waypoint in the Route.
2. Press **[ROUTE]**, you will notice the Starting Waypoint will be placed under the cursor.
3. Move the ShuttlePoint knob to the second Lat/Lon of the next leg in the Route.
4. Press **[ROUTE]**. You will notice another Waypoint is shown under the cursor and a line joins the starting Waypoint to the Second Waypoint.

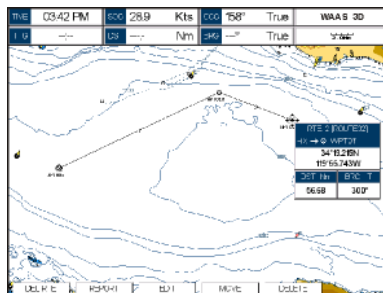

Figure 9.0 - Creating a Route using Waypoints

5. Repeat steps 3 and 4 until all Waypoints are entered into the Route.

#### NOTE

At this point the Route is saved as ROUTE01. If you would like to save the Route under a specific name follow the next steps.

## 9.1 CHANGING THE NAME OF A ROUTE

To name the Route:

1. Place the ShuttlePoint knob on the Route (on Waypoint or on leg) and press **[EDIT]**.
2. Move the ShuttlePoint knob to highlight **NAME** and press **[ENT]**. A popup window will be shown.
3. Move the ShuttlePoint knob up/down to change the characters and left/right to select a different character in the Routes Name.

EDIT ROUTE						
ROUTE 1	NAME (ROUTE)	BRG	LEGT	SPCD (kts)	FUEL (lb)	
WAYPOINT	21 CTULJE		NM			
	33° 48.22' N					
	81° 02.00' W					
CPZDZM	22 CTULJE					
	33° 48.22' N					
	81° 02.00' W					
WP1002	23 CTULJE	272°	99.0	186.0	090.7	186
	33° 48.22' N					
	81° 02.00' W					
WP1003	24 CTULJE	272°	91	107	10.14	107
	33° 48.22' N					
	81° 02.00' W					
WP1004	25 CTULJE	0°	372.0	186.0	18.0	186.0
	33° 48.22' N					
	81° 02.00' W					
WP1005	26 CTULJE	387°	736.0	186.0	133.06	186
	33° 48.22' N					
	81° 02.00' W					
WP1006	27 CTULJE	117°	99.0	224.0	223.64	224
	33° 48.22' N					
	81° 02.00' W					

Figure 9.1 - Edit Route

4. When finished press **[ENT]** to save.
5. Press **[CLR]** to show the Chart page.

## 9.2 CREATING AN OLYMPIC ROUTE

This feature allows the starting point in a Route to be saved as the final destination point.

1. On the Chart page move the ShuttlePoint knob to the Lat/Lon of the starting Waypoint in the Route.
2. Press **[ROUTE]**, the starting Waypoint will be placed under the cursor.
3. Move the ShuttlePoint knob to the second Lat/Lon of the next leg in the Route.
4. Press **[ROUTE]**. Another Waypoint is shown under the cursor and a line joins the starting Waypoint to the second Waypoint.
5. Repeat steps 3 and 4 until all Waypoints are entered into the Route.

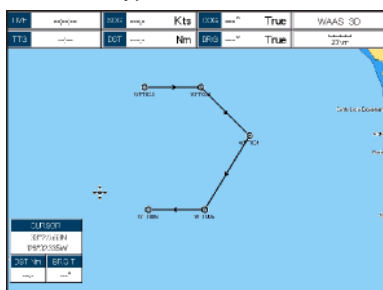

Figure 9.2 - Olympic Route creation (1)

6. Then move the ShuttlePoint knob to the last Waypoint.
7. Press **[OLYMPIC]**. A line joins the starting Waypoint and the last Waypoint.

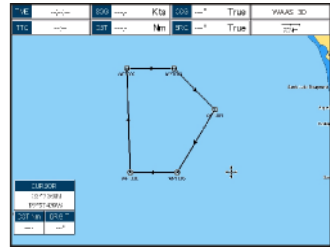
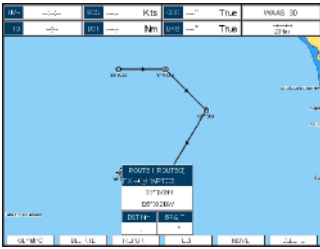

Figure 9.2a - Olympic Route creation (2)

### 9.3 MAKING ADDITIONAL ROUTES

To create another Route the GPS Chart Plotter must be told that you want to create a second Route.

1. Move the ShuttlePoint knob to the existing Route and then press **[EDIT]**.
2. Move the ShuttlePoint knob to highlight **SELECT** and press **[ENT]**.
3. Move the ShuttlePoint knob to an open Route number: example, Route 2. Press **[ENT]**.
4. Press **[CLR]**.
5. To create the new Route, follow now the steps in the previous section “Creating a Route using Waypoints”.

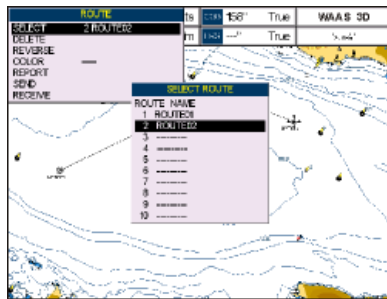

Figure 9.3 - Create additional Route

### 9.4 CREATING A ROUTE USING MARKS ON THE CHART PAGE

To create a Route containing Marks you first must create the Marks and show them on the Chart page.

1. Move the ShuttlePoint knob over the top of a Mark that you wish to be the starting point in the Route and press **[ROUTE]**.
2. Next move the ShuttlePoint knob until the cursor is over the Mark that you want to be the next leg in the Route.
3. Press **[ROUTE]**. You will notice a bearing line joins the first and second Mark which means these Marks are selected into the Route.
4. Repeat steps 3 and 4 until all Marks are entered into the Route.

#### NOTE

At this point the Route is saved as ROUTE01. If you would like to save the Route under a specific name follow the steps on the previous Par. 9.1.

## 9.5 INSERTING A WAYPOINT INTO A ROUTE

1. Place the cursor on the navigation line between two Waypoints and press **[INSERT]**. The line between the two Waypoints is turned into a dotted line, see the following picture:

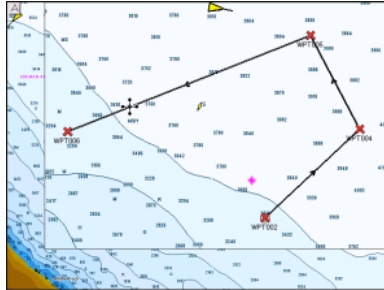

Figure 9.5 - Inserting Waypoint procedure (step 1)

2. Move the ShuttlePoint knob to the desired location for the new Waypoint: the line will “rubber-band”, drawing a dotted line between the previous Waypoint and the cursor, and another dotted line between the cursor and the next Waypoint (see the left side of the above picture).
3. Once you have positioned the cursor at the location you want, press **[ENT]** (see the right side of the above picture).

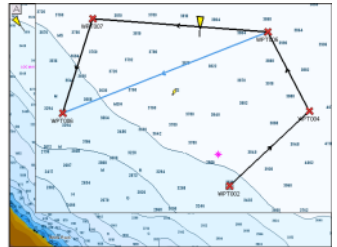
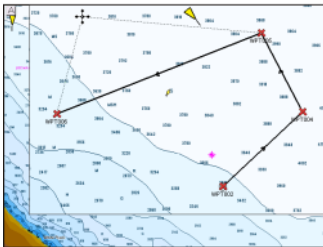

Figure 9.5a - Inserting Waypoint procedure (step 2 and 3)

## 9.6 GOTO A ROUTE

By having created some Routes, you can choose one of them to place a GOTO on.

### 9.6.0 Using [GOTO] to select Route

1. Move the ShuttlePoint knob to an open position (no buoy, warning etc. under the cursor) on the Chart page.
2. Press **[GOTO]** to show the GOTO popup window.
3. Move the ShuttlePoint knob to highlight **ROUTE** and press **[ENT]**.
4. The SELECT ROUTE popup window will be shown.

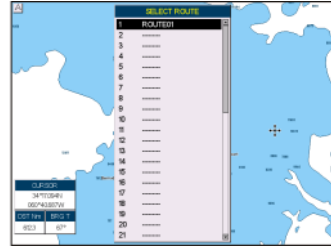

Figure 9.6.0 - GOTO ROUTE procedure (1)

5. Move the ShuttlePoint knob to highlight the desired Route and press **[ENT]**.
6. On the Chart page, a circle with a Flag is shown on the first leg of the Route you chose and a navigation line is shown, indicating the GPS Chart Plotter is navigating to the first Waypoint in the Route.

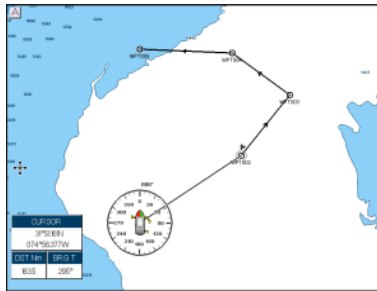

Figure 9.6.0a - GOTO ROUTE procedure (2)

### 9.6.1 Using the ShuttlePoint knob

1. On the Chart page move the ShuttlePoint knob until the cursor reaches the starting point of the Route.
2. Press **[GOTO]** to start following the Route.
3. Press **[CLR]** twice to revert to Home mode.

## 9.7 DELETING A ROUTE

To delete a Route follow the procedure below:

1. Press **[MENU]**, move the ShuttlePoint knob to highlight **USER POINTS** and press **[ENT]**.
2. Move the ShuttlePoint knob to highlight **ROUTE** and press **[ENT]**.
3. Move the ShuttlePoint knob to highlight **DELETE** and press **[ENT]** or move the ShuttlePoint knob to the right.
4. A Warning message appears to confirm. Move the ShuttlePoint knob to highlight **YES** and press **[ENT]**. The Route has been deleted.

### WARNING

An active Route (one that you are navigating to) cannot be deleted until you stop navigating to the Route.

## 9.8 OTHER SETTINGS IN ROUTE MENU

---

You will notice the **ROUTE** menu has other selections.

<b>SELECT</b>	Choose an available Route to create or choose a stored Route to show and follow on the Chart page.
<b>REVERSE</b>	Reverses the Route, when chosen Starting point is at the end of the Route.
<b>COLOR</b>	Allows changing the color of the navigation lines between each leg in the Route.
<b>EDIT</b>	The Edit Route (Route Report) menu is useful to show details of the Waypoints contained within the Route. This menu also allows you to enter in your average speed and fuel consumption and calculate the approximate fuel used when following the Route.
<b>SEND</b>	Sends the stored points to a external device (PC) capable of listening to NMEA RTE sentence.
<b>RECEIVE</b>	Receive the points from an external device (PC) capable of sending NMEA RTE sentence.
<b>THICKNESS</b>	Selection that allows the Route line to be easily seen; default selection is Thick.

### 9.8.0 Route Check

The Route Check function is used after you have created a Route to ensure you and your vessel will not have problems while navigating. This is done by the CP590 by reviewing the Route and looking for the following hazards that may effect safe navigation.

- Land Areas
- Shallow Water
- Intertidal Areas (*areas emerged at low tide*)
- Rocks
- Wrecks
- Obstructions
- Shoreline Constructions
- Fishing Facility
- Dredged Areas
- Diffusers (*submarine pipeline*)
- Mooring/Warping Facility
- Production Installation (*an installation for the exploitation of natural resources*)
- Pingos (*small conical hills having a large central core of ice formed from the encroachment of permafrost and the resulting hydrostatic pressure*)
- No Data Available (*no adequate data coverage*)

If any of these alarm conditions is detected, the function returns the list of dangerous objects and the relative dangerous Route leg, that is drawn with a different color.

- Route legs which were classified as dangerous are displayed in RED. It means that there is at least one dangerous object in the vicinity of this leg and it has been found.
- Route legs which were classified as safe are displayed in GREEN. It means that the data was checked on detailed chart levels and no problems were found for all segments of the leg.
- Route legs for which there was not sufficient data to be checked are displayed in YELLOW. It means that no problems were found but the data was not sufficient or not available at all to classify such a leg as safe.



Figure 9.8.0 - Example of dangerous objects found on the chart

To activate this function:

<b>AUTOMATIC CHECK</b>	Turns the Route Checking feature On or Off. Turn the Automatic Route Check on after you have created a new Route, or if you inserted a new Waypoint, deleted, moved or edited any Waypoint in a saved Route to confirm the Route can be safely navigated.
<b>ROUTE WIDTH</b>	This selection allows you to select the width from the left and right of the Route leg where the GPS Chart Plotter will check to confirm navigation threats. See the picture below. The default for this selection is 0.04Nm.
<b>DEPTH LIMIT</b>	This selection allows you to select the water depth in the Route width area so the GPS Chart Plotter can check and confirm underwater threats. It checks if some objects with the depth attribute (like Shallow Water, Dredged Areas, Diffusers, Obstructions, Pingos, Production Installation and Wrecks) are above this depth level. Only if the depth attribute is above the depth limit are they found and considered as dangerous. See the picture below. The default setting is 10Ft.
<b>ACCURACY</b>	Defines a segment length into which a leg of the Route is divided in order to execute the search for dangerous objects with better accuracy. When accuracy is maximal, a segment length is the shortest. When accuracy is minimal, a segment length is the longest. Selects among Minimum, Low, Medium, High and Maximum. See the picture below. The default setting is Medium.
<b>ROUTE CHECK REPORT</b>	Shows the list of the dangerous objects found on the charts crossed by the Route.

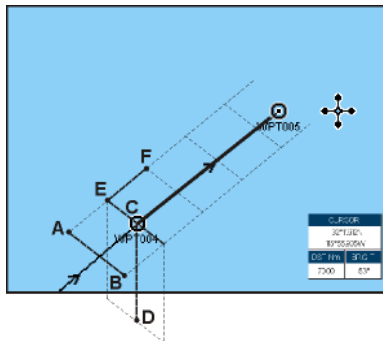

Figure 9.8.0a - Route Check parameters

**NOTE**

Although the functionality is called Route Check, it can also be activated when the navigation is set to a single point (like DSC, MOB, Mark). In the case of checking a single point towards which the navigation is started, the leg for which the Route Check is executed is defined by the current position (the leg's starting point) and the destination point (the leg's ending point).



---

## 10. TRACKS

---

The CP590 has the capability to store 20 individual tracks and record up to 10,000 Track Points.

Before using the Track function you will need to setup the Track function that suits your boat. The Track function records your tracks your vessels location as it moves through the water. The Track function can be setup to lay down a Track for a predetermined time or distance interval. If you have a fast moving boat you may want to setup the GPS Chart Plotter to record a Track point every 0.5Nm or if you have a sail boat you may want to setup to lay down a Track point once ever 1 minute.

### NOTE

Please note the Track point memory is 10,000 points. This means for a long journey you may have to adjust the time or distance to be able to track your journey. It should be noted when the 10,000 Track points are used up, the first Track point layed down will be deleted when a new point is placed on the chart.

1. Press **[MENU]**, move the ShuttlePoint knob to highlight **USER POINTS** and press **[ENT]**.
2. Move the ShuttlePoint knob to highlight **TRACK** and press **[ENT]**.
3. Move the ShuttlePoint knob to highlight **STEP UNIT** and press **[ENT]** or move the ShuttlePoint knob to the right.
4. Move the ShuttlePoint knob to highlight and choose **Dist** or **Time** and press **[ENT]** or move the ShuttlePoint knob to the right.

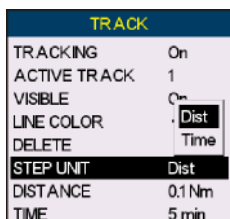

Figure 10 - Distance Units and Time Units

5. Move the ShuttlePoint knob to highlight **DISTANCE** or **TIME** step interval and press **[ENT]** or move the ShuttlePoint knob to the right.
6. Move the ShuttlePoint knob up/down to the desired step value and press **[ENT]** or move the ShuttlePoint knob to the right.
7. Press **[CLR]** or move the ShuttlePoint knob to the left until the Chart Page is shown.

---

### 10.0 TRACKING

---

When using the tracking feature you will notice every time a Track Point is layed down on the Chart page a small filled in circle is shown on the Track line. If you move the cursor over the top of the circle a popup window will be shown with the Time, Water Temperature, Speed and Course Over Ground (COG). This is very useful if you are fishing and want to review the conditions where the fish were being caught.

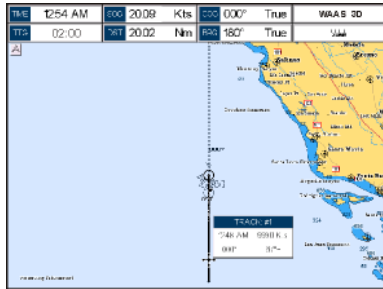

Figure 10.0 - Tracking

## 10.0.0 Saving and starting a new Track

A Track is automatically saved and retained in memory when the power is turned off. To start a new Track:

1. Press **[MENU]**, move the ShuttlePoint knob to highlight **USER POINTS** and press **[ENT]**.
2. Move the ShuttlePoint knob to highlight **TRACK** and press **[ENT]**.
3. Move the ShuttlePoint knob to highlight **ACTIVE TRACK** and press **[ENT]** or move the ShuttlePoint knob to the right.
4. Move the ShuttlePoint knob up/down to select the next available open Track and press **[ENT]** or move the ShuttlePoint knob to the right.
5. Move the ShuttlePoint knob to highlight **TRACKING** and press **[ENT]**. Move the ShuttlePoint knob to set On and press **[ENT]**.
6. Press **[CLR]** or move the ShuttlePoint knob to the left until the Chart page is shown.
7. A new Track now will be laid down.

### 10.0.1 Deleting a Track

To delete a Track:

1. Press **[MENU]**, move the ShuttlePoint knob to highlight **USER POINTS** and press **[ENT]**.
2. Move the ShuttlePoint knob to highlight **TRACK** and press **[ENT]**.
3. Move the ShuttlePoint knob to highlight **DELETE** and press **[ENT]** or move the ShuttlePoint knob to the right.
4. A warning popup window will be shown to confirm if you want to reset the Track. Move the ShuttlePoint knob to highlight **YES** and press **[ENT]** or move the ShuttlePoint knob to the right. The Track is now deleted.
5. Press **[CLR]** or move the ShuttlePoint knob to the left until the Chart page is shown.

### 10.0.2 Other settings

You will notice the Track Menu has other selections:

<b>TRACKING</b>	Allows turning on or off the tracking function
<b>ACTIVE TRACK</b>	This selection allows you to save a Track to one of the 5 Tracks available
<b>VISIBLE</b>	Shows or hides a Track shown in ACTIVE TRACK menu
<b>LINE COLOR</b>	Selects the color of the Track line
<b>DELETE</b>	Deletes a Track selected in the ACTIVE TRACK menu



---

# 11. USER C-CARD

---

The optional User C-CARD is used to back up Marks, Routes, and Tracks stored in your GPS Chart Plotter's memory. In the USA the User C-CARD is available directly from Jeppesen Marine at 800/424-2627. The User C-CARD is similar to a backup disk used with a PC, in case you have to clear the RAM to resolve an issue or load new software, or if you would like to transfer Waypoint, Track and Route information from one STANDARD HORIZON GPS Chart Plotter to another.

---

## 11.0 USER C-CARD MENU

---

This optional card is similar to using a floppy disk or memory stick on a PC to backup your files or to transfer the information that you have stored to a friends GPS Chart Plotter. The information shown below will assist you to transfer the User Points, Routes and Track history to the optional User C-CARD.

To open the User C-CARD page:

1. Press **[MENU]**, move the ShuttlePoint knob to highlight **USER POINTS** and press **[ENT]**.
2. Move the ShuttlePoint knob to highlight **USER C-CARD** and press **[ENT]**.

- ① Number of selected Slot
- ② Number of selected File
- ③ Information on stored User Points on Internal Memory
- ④ Time of file creation
- ⑤ Date of file creation
- ⑥ Type of data contained in the file (Mark file, Waypoint file...)
- ⑦ File name

SLOT	NAME	TYPE	DATE	TIME
1	FILE01	MARKS	03/04/07	11:03:05
2	FILE01	MARKS	03/04/07	22:05:41
3	FILE01	TRACKS	07/04/07	03:11:05

Figure 11.0 - User C-CARD Menu

### 11.0.0 Formatting the optional User C-CARD

1. Press **[MENU]**, move the ShuttlePoint knob to highlight **USER POINTS** and press **[ENT]**.
2. Move the ShuttlePoint knob to highlight **USER C-CARD** and press **[ENT]**.
3. Move the ShuttlePoint knob to highlight **FORMAT** and press **[ENT]**.
4. A popup Warning window will to confirm you want to format the User C-CARD.
5. Select **YES** and press **[ENT]** to confirm (select **NO** otherwise). The format of User C-CARD must be done before using a new User C-CARD: this operation prepares the User C-CARD to receive and store information.

#### NOTE

---

Formatting permanently erases all files previously saved on the User C-CARD.

---

### 11.0.1 Transferring files to the optional User C-CARD

1. Remove a C-MAP BY JEPPESEN NT\*/MAX C-CARD if present and insert the optional User C-CARD into the slot.
2. Press **[MENU]**, move the ShuttlePoint knob to highlight **USER POINTS** and press **[ENT]**.
3. Move the ShuttlePoint knob to highlight **USER C-CARD** and press **[ENT]**.
4. Move the ShuttlePoint knob to highlight **SAVE** and press **[ENT]**.
5. A popup **SAVE FILE** window appears. In this window you can change the Name and the file Type by using the ShuttlePoint knob.
6. To save the file, move the ShuttlePoint knob to SAVE in window and press **[ENT]**.
7. A Information pop window will momentarily be shown "SAVING" then show SAVING OK.
8. Press **[ENT]** to confirm.

### 11.0.2 Loading a file from the optional User C-CARD

If you have a problem and accidentally loose the User Points in the GPS Chart Plotter with the optional User C-CARD it is possible to load the data back into the GPS Chart Plotter using the following procedure:

1. Press **[MENU]**, move the ShuttlePoint knob to highlight **USER POINTS** and press **[ENT]**.
2. Move the ShuttlePoint knob to highlight **USER C-CARD** and press **[ENT]**. A screen will appear.
3. Select the file from the User C-CARD list by using the ShuttlePoint knob and press **[ENT]**.
4. Move the ShuttlePoint knob to highlight **LOAD** and press **[ENT]**.
5. A "LOADING" message will momentarily be shown then a pop up Information window show "LOADING...OK".
6. Press **[ENT]** to confirm.

### 11.0.3 Deleting a file from the optional User C-CARD

You may want to delete a saved file on the User C-CARD.

1. Press **[MENU]**, move the ShuttlePoint knob to highlight **USER POINTS** and press **[ENT]**.
2. Move the ShuttlePoint knob to highlight **USER C-CARD** and press **[ENT]**. A screen will appear.
3. Select the file from the User C-CARD list by using the ShuttlePoint knob and press **[ENT]**.
4. Move the ShuttlePoint knob to highlight **DELETE** and press **[ENT]**.
5. A popup Warning window will to confirm you want to delete the file. Select **YES** and press **[ENT]** to confirm (select **NO** otherwise).
6. Press **[ENT]** to confirm.

### 11.0.4 Changing the optional User C-CARD

You may want to change the User C-CARD inserted in the slot with a new one.

1. Press **[MENU]**, move the ShuttlePoint knob to highlight **USER POINTS** and press **[ENT]**.
2. Move the ShuttlePoint knob to highlight **USER C-CARD** and press **[ENT]**. A screen will appear.
3. Open the door. Change the User C-CARD into the same slot or insert a new one into the other slot.
4. Move the ShuttlePoint knob to highlight **CHANGE** and press **[ENT]** to confirm.

## 12. PAGES

The GPS Chart Plotter has many pages that are designed to ease your navigation.



Figure 12 - Screen display pages example

The pages can be selected in the following ways:

- **Selection by MENU**

1. Press **[MENU]**. The following menu is shown on the screen:

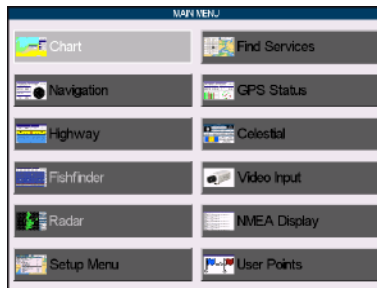

Figure 12a - Main Menu

2. Move the ShuttlePoint knob to highlight the desired page and press **[ENT]**.

- **Selection by SOFT KEY**

Press one of the Soft Keys under the display, then press the relating Soft Key to show the desired page.

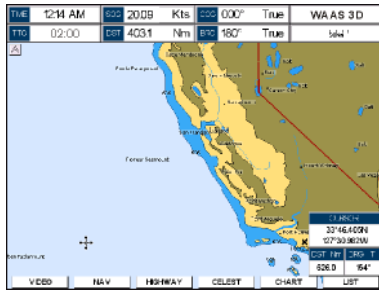

Figure 12b - Screen display pages by Soft Keys

## 12.0 CHART PAGE

The Chart page is the main page of the GPS Chart Plotter. From this page the user can zoom in/out, pan around the chart, show information about cartographic objects, see the exact vessel position with the COG and SOG, place points, GOTO a destination point, show Track history etc. The GPS Chart Plotter come with Built-In Charts for coastal navigation of USA including Alaska, Hawaii and Great Lakes, Canada, Bahamas, Caribbean, Cuba, Puerto Rico, and Central America. For detail refer to Par. 5.0. For more detail, optional C-MAP BY JEPPESEN NT+/MAX C-CARDS or to update the Built-In Charts, refer to Par. 5.1.

It is possible to set the chart as a single or two charts side by side.

1. Press **[MENU]**, move the ShuttlePoint knob to highlight **CHART** and press **[ENT]**. Two Chart page types are available: Single and Dual.
2. Move the ShuttlePoint knob to highlight **Single** or **Dual** and press **[ENT]**.

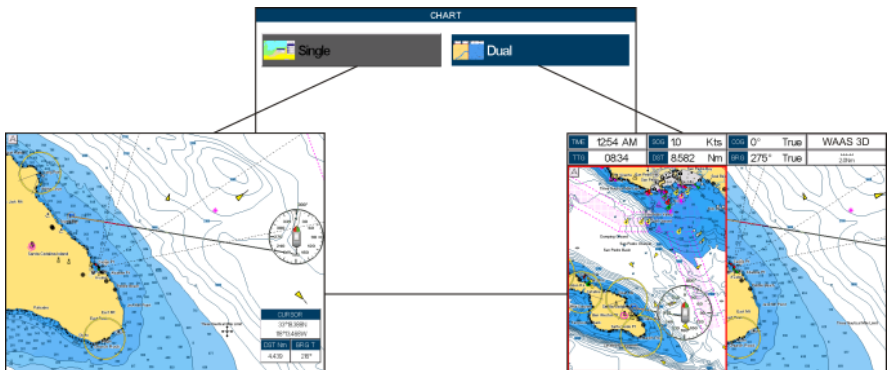



Figure 12.0 - Chart selection menu

### NOTE

 may appear on the unused window of the Dual Chart page. It happens when the GPS Chart Plotter updates the displayed chart in the not active window. So the user understands that the GPS Chart Plotter is busy.

## 12.0.0 Focus Soft Key on Dual Chart Page

When Dual Chart is selected, you will notice one of the chart windows will have a red border around it. This red border indicates which chart window the chart plotter has the Focus on, meaning if the ShuttlePoint knob is moved the cursor on chart window will move. The focus may be changed to the other chart window with the procedure below:

1. Press any Soft Key. The Soft Key labels appear on the bottom of the screen. A **[Focus]** Soft Key will be shown.

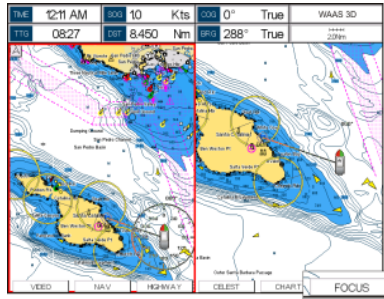

Figure 12.0.0 - Example of Dual Chart page with **[Focus]** shown

2. Press **[Focus]**. A popup window appears where the active focus window label is highlighted.

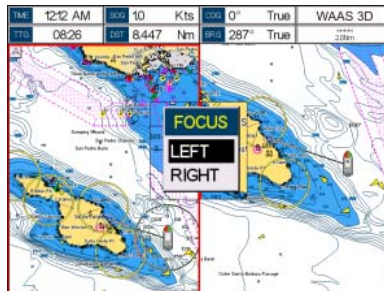

Figure 12.0.0a - Example of Dual Chart page with **[Focus]** window shown

3. Move the ShuttlePoint knob up and down to highlight the desired item and press **[ENT]**. The red border is moved to the focused window.



## 12.0.1 Single Chart Page

① Time

② Speed Over Ground

③ Course Over Ground

④ Fix status

Time To Go

⑤ (If plotter is not navigating to a point TTG will show --:--)

Distance from Fix to Destination  
⑥ (If plotter is not navigating to a point DST will show ---)

⑦ Bearing from Fix to Destination  
(If plotter is not navigating to a point BRG will show ---°)

⑧ Chart Scale

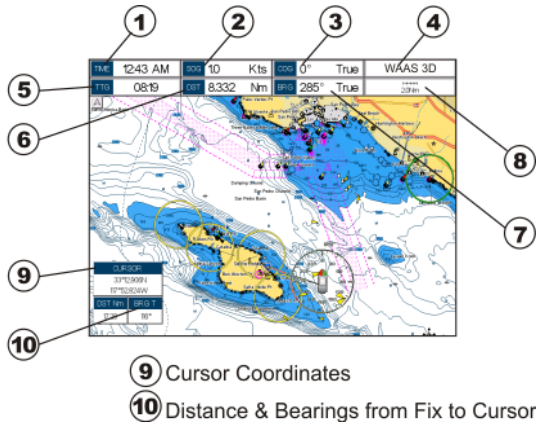

Figure 12.0.1 - Example of single Chart Page

## 12.0.2 Window Selections

The default is the Two Line Small window. The CP590 windows may be changed by the procedure below.

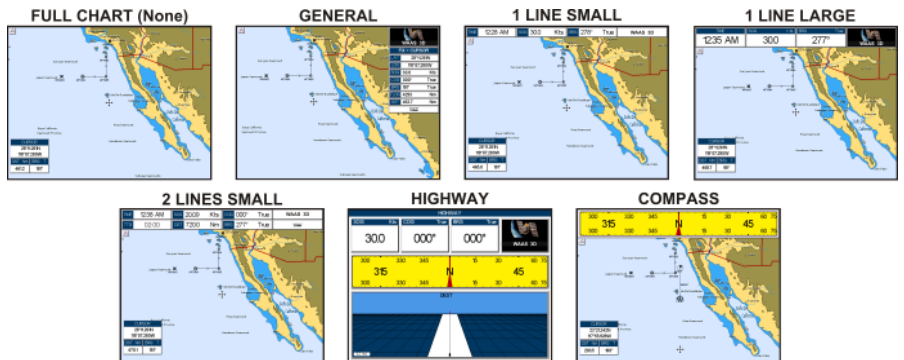

Figure 12.0.2 - Data window layout

1. To change, press **[MENU]**, move the ShuttlePoint knob to highlight **SETUP MENU** and press **[ENT]**.
2. Move the ShuttlePoint knob to highlight **GENERAL SETUP** and press **[ENT]**.
3. Move the ShuttlePoint knob to highlight **WINDOW SETUP** and press **[ENT]**.
4. Move the ShuttlePoint knob to highlight **CHART PAGE** and press **[ENT]**.
5. Select the desired window, **HIGHWAY** or **COMPASS**, and press **[ENT]**.
6. Press **[CLR]** or move the ShuttlePoint knob to exit the menu and show the Chart page.

## 12.0.3 Customizing the Data Windows

The data fields contained on the General, 1 Line Small/Large and 2 Line Small data windows

can be changed to the following selections:

- MAX SPD = Max Speed
- SOG = Speed Over Ground
- COG = Course Over Ground
- DST = Distance to Destination<sup>1</sup>
- BRG = Bearing to Destination<sup>1</sup>
- XTE = Cross Track Error
- TTG = Time To Go
- STR = Steering
- HDG = Heading from Electronic Compass
- DTP = Depth
- SPD = Speed
- ALT = Altitude
- AWS = Apparent Wind Speed
- AWD = Apparent Wind Direction
- TWS = True Wind Speed
- TWD = True Wind Direction
- HDOP = Horizontal Dilution of Precision
- VDOP = Vertical Dilution of Precision
- Temp = Water Temperature
- TLOG = Trip Log
- Date = Current Date
- Time = Current Time
- VMG = Velocity Made Good
- ETA = Estimated Time of Arrival
- Scale = Chart Scale
- GSP Status = Shows GPS Fix Status (WAAS, 3D, 2D, ...)

---

NOTE<sup>1</sup>

When the GENERAL window is selected and the GPS chart plotter is in Home Mode, the BRG will show - - -, unless the GPS chart plotter is navigating to a point. When in Cursor Mode, the BRG shows the Bearing from the ship's position to the cursor location.

---

To select the desired field, follow the procedure:

1. Press and hold **[MENU]** until a field is highlighted (it will be shown in a yellow frame).
2. Move the ShuttlePoint knob to the desired data field (the yellow frame is moved to the desired data field) and press **[ENT]**. The popup window will be shown.
3. Move the ShuttlePoint knob up/down or left/right to choose the desired setting and press **[ENT]**.
4. Press **[CLR]** to store and exit the editing mode.

---

NOTE

Data window field on the NAVIGATION, HIGHWAY, GPS STATUS, and NMEA pages may be customized in the above manner.

---

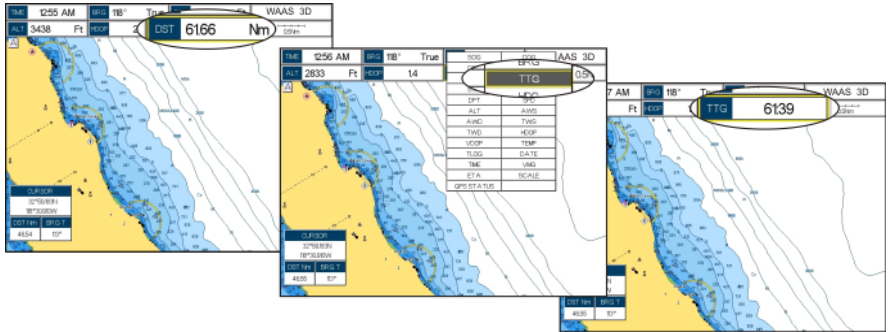

Figure 12.0.3 - Customizing the Data Windows

### NOTE

See Par. 10.1.0 if Trip Log is selected in one of the data windows and you want to reset the log.

## 12.0.4 Additional Functions on Chart Page

When on the Chart page, you will notice icons of Buoys, Towers, Lights, Wrecks, Tide Stations and Port Icons. If the cursor is moved over the top of these icons a popup window will be shown with information about the icon.

## 12.0.5 Turning Off Information on Icon Points

The GPS Chart Plotter allows you to select to see information on points, on all items or to turn this function off. The default setting is On Points.

1. To change, press **[MENU]**, move the ShuttlePoint knob to highlight **SETUP MENU** and press **[ENT]**.
2. Move the ShuttlePoint knob to highlight **GENERAL SETUP** and press **[ENT]**.
3. Move the ShuttlePoint knob to highlight **AUTO INFO** and press **[ENT]**.
4. Move the ShuttlePoint knob up or down to highlight **OFF**, **ON POINTS** or **ON ALL** and press **[ENT]** or move the ShuttlePoint knob to the right.
5. Press **[CLR]** or move the ShuttlePoint knob to the left until the Chart page appears.

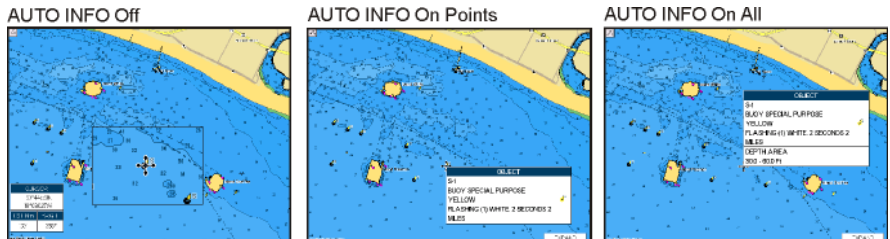

Figure 12.0.5 - Example of Auto Info settings

## 12.0.6 Display Mode

Selects from a pre-defined table what cartographic objects are displayed and which display options are set. Pre-programmed settings are user selectable from Full, Medium, Low, Radar

(reduces the information on the display to simulate items that would be shown on a RADAR display. Please note this function is not actually showing RADAR information it is only showing what typically would be shown by a separate dedicated RADAR display) and Tides modes. Besides, the Custom mode is available as default and it is configurable by the user.

The table below shows the selections for each mode.

To change to one of the pre-programmed settings

1. Press **[MENU]**, move the ShuttlePoint knob to highlight **SETUP MENU** and press **[ENT]**.
2. Move the ShuttlePoint knob to highlight **CHART CONFIGURATIONS** and press **[ENT]**.
3. Move the ShuttlePoint knob to highlight **DISPLAY MODE** and press **[ENT]**.
4. Move the ShuttlePoint knob up or down to select the preset and press **[ENT]**.
5. Press **[CLR]** until the Chart Page is shown.

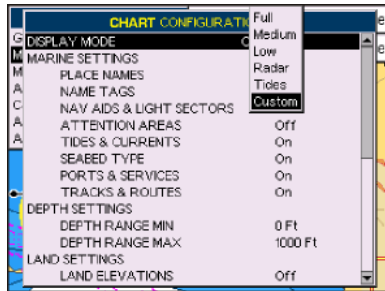

Figure 12.0.6 - Display Mode settings

The table below shows the selections for each mode:

Setting	Full	Medium	Low	Radar	Tides	Custom (Default values)
Place Names	On	On	On	On	On	On
Name Tags	On	Off	Off	Off	Off	Off
Nav Aids & Light Sectors	On	No Sectors	No Sectors	No Sectors	Off	On
Attention Areas	On	On	Off	Off	Off	Off
Tides & Currents	On	Off	Off	Off	On	On
Seabed Type	On	Off	Off	Off	Off	On
Ports & Services	On	On	Off	On	Off	On
Tracks & Routes	On	Off	Off	Off	Off	On
Depth Range Min	0Ft	0Ft	0Ft	0Ft	0Ft	0 Ft
Depth Range Max	32804Ft	32804Ft	32804Ft	32804Ft	32804Ft	32804Ft
Land Elevations	On	On	Off	Off	Off	Off
Land Elevation Values	On	Off	Off	Off	Off	On
Roads	On	Off	Off	Off	Off	On
Points Of Interest	On	Off	Off	Off	Off	On
Lat/Lon Grid	On	Off	Off	Off	Off	Off
Chart Boundaries	On	Auto	Off	Off	Off	Off
Value-Added Data	On	Off	Off	Off	On	On
Chart Lock	On	On	On	On	On	On
Mixing Levels	On	On	On	On	On	On
Underwater Ob. Limit	1000Ft	32Ft	32Ft	32Ft	32Ft	1000Ft
Rocks	Icon + Depth	Icon	Icon	Icon	Icon	Icon
Obstructions	Icon + Depth	Icon	Icon	Icon	Icon	Icon
Diffusers	Icon + Depth	Icon	Icon	Icon	Icon	Icon
Wrecks	Icon + Depth	Icon	Icon	Icon	Icon	Icon

## 12.0.7 Marine Settings

To control the display on the chart of the marine features.

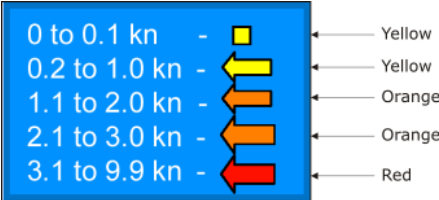
<b>Place Names</b>	: Turns the Local area names On or Off.
<b>Names Tags</b>	: Turns a tag for particular chart objects that either includes the Name of the chart object or the Depth of an Underwater chart object On or Off.
<b>Nav Aids &amp; Light Sectors:</b>	Turns the presentation of Lights, Signals, Buoys and Beacons On (Nav-Aids & Light Sectors are shown), Off (Nav-Aids & Light Sectors are not shown) or No Sector (Nav-Aids are shown, Light Sectors are hidden).
<b>Attention Areas</b>	: Turns the Attention Areas (areas in which special attention by the mariner is required because of natural or man-made hazards sailing regulations and restrictions) On or Off.
<b>Tides &amp; Currents</b>	: Turns the Tides and Currents On or Off. When data/time is available, Tidal stream arrows are shown on the charts, indicating the direction and strength of the Tide. If no data/time is available from the GPS or the GPS Chart Plotter is not in Simulation mode, the icon on the chart is generic one. The color of the arrow denotes the strength of the current as follows:
	
When the GPS Chart Plotter receives a valid position fix, the Tide icons are shown on the charts on the basis of the current date and time: the screen displays and changes arrows as date/time changes.	
<b>Seabed Type</b>	: Turns the Seabed type On or Off.
<b>Ports &amp; Services</b>	: Turns the Ports and Service icons On or Off. Areas along the shore with facilities for mooring, downloading and uploading of ships, generally sheltered from waves and winds. Port installations are piers, wharves, pontoons, dry docks, cranes....
<b>Tracks &amp; Routes</b>	: Turns the underwater objects On or Off. Objects are obstructions, wrecks, cable etc.

## 12.0.8 Depth Settings

Controls the depth information on the Chart page.

<b>Depth Range Min</b>	: Sets the minimum depth limit to show Depth Sounding, Bathymetric Lines and Depth Area.
<b>Depth Range Max</b>	: Sets the max depth limit to show Depth Sounding, Bathymetric Lines and Depth Area.

0-1000 Ft

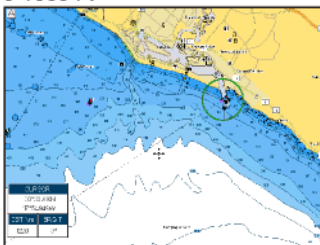

50-100 Ft



Figure 12.0.8 - Depth Settings

## 12.0.9 Land Settings

To control the display on the chart of the terrestrial features.

<b>Land Elevations</b>	: Turns the Land Elevations On or Off.
<b>Land Elevation Values</b>	: Turns the Land Elevation Values On or Off.

**Roads** : Turns the Roads On or Off.

**Points Of Interest** : Turns the Points of Information On or Off.



① ROAD

② POINT OF INTEREST (LIBRARY)

Figure 12.0.9 - Example of Roads and Points Of Interest

## 12.0.10 Chart Settings

Settings that control how the chart features will be shown on the Chart Page of the GPS Chart Plotter.

**Lat/Lon Grid** : Turns the Latitude and Longitude grid lines On or Off on the Chart page. See the figure below:

**Lat/Lon Grid ON**

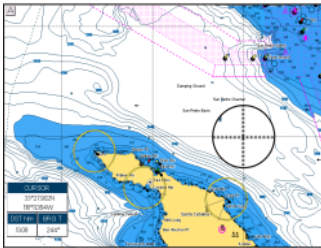

**Lat/Lon Grid OFF**

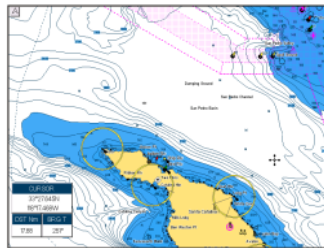

**Chart Boundaries** : Turns the Chart Boundaries On, Off or Auto. The Chart Boundaries are the "ticked" boxes surround the coastline. Each box indicates an area where more detail is available. The Chart Boundaries are only show when a C-MAP By JEPPESEN NT\* or MAX CARD is inserted into the GPS Chart Plotter. See the pictures below:

**Chart Boundaries ON**

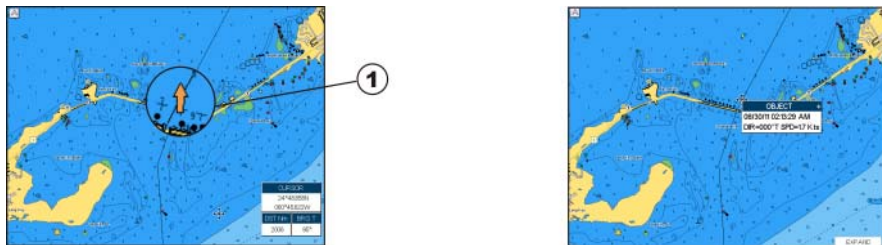

**Chart Boundaries OFF**



**Value Added Data** : Turns the Value Added Data On or Off. The Value Added Data (VAD) is a collection of additional cartographic objects which are not present on the original paper chart (from which the electronic chart derives). These objects have been obtained from other sources and then merged to the electronic charts in order to provide more information useful for the navigation. VAD object can

be any cartographic objects and it can be distinguished from the official-chart-objects from the Quick Info. A dedicated icon is shown on the Quick Info window to indicate that the object queried is a VAD. The same icon is also shown on the Full Info page and in addition the extended text Value Added Data is shown on the details of the VAD object. See the figure below:



① Example of VAD object

- Chart Lock (\*)** : Turns the chart function On/Off. When Chart Lock is On, the available zoom scales are only the ones containing cartographic data. Instead when Chart Lock is Off, it is possible to zoom down into zoom scales not covered by cartographic data after the last available zoom scale covered by cartographic data. The DSI (Data Safety Indicator) window, if present, will show "NO CHART", when an empty level is entered in the location of chart expansion mode.
- Mixing Levels** : When the chart coverage at the current chart scale does not fill the entire display, the GPS Chart Plotter draws the rest of the chart using charts from above and below the current scale. When this function is turned on you will notice the display may redraw 2 to 3 times to show all the details

NOTE\*

When an empty level is entered, the message "No cartographic coverage" is shown on a window in a corner of the chart display. The warning message is always displayed as long as the current zoom has no data coverage.

## 12.0.11 Underwater Objects Settings

The following selections are used to control which Underwater Objects are shown on the Chart Page.

- Underwater Object Limit** : Selects the max depth value to display Underwater Objects. If value is set to 0Ft, the Underwater Objects are not shown on the charts. Menu options are greyed out. If value is more than 0Ft (i.e. 10Ft), in the Range from 0Ft to the selected value the Underwater Objects are displayed according to their setting below.
- Rocks** : Sets Off/Icon/Icon+Depth\* the displaying of the Rocks.
- Obstructions** : Sets Off/Icon/Icon+Depth\* the displaying of the Obstructions.
- Diffusers** : Sets Off/Icon/Icon+Depth\* the displaying of Diffusers (Diffuser is a structure on an outfall through which liquids are discharged. The structure will usually project above the level of the outfall and can be an obstruction to navigation).
- Wrecks** : Sets Off/Icon/Icon+Depth\* the displaying of Wrecks.

NOTE\*

Choose the options: OFF (the object is not visible independently of the selected "Underwater Object Depth Value"); ICON (the object icon is visible without tags, in the range selected from "Underwater Object Depth Value" option); ICON+DEPTH (the object icon and tag is visible, in the range selected from "Underwater Object Depth Value" option).

## 12.1 CUSTOMIZING CHART SETTINGS

The GPS Chart Plotter also allows you to customize items shown on the chart (discussed in above sections) instead of using a pre-defined table discussed in Par. 12.0.4 Display Mode.

1. Press **[MENU]**, move the ShuttlePoint knob to highlight **SETUP MENU** and press **[ENT]**.
2. Move the ShuttlePoint knob to highlight **CHART CONFIGURATIONS** and press **[ENT]** or move the ShuttlePoint knob to the right.
3. Move the ShuttlePoint knob to highlight **DISPLAY MODE** and press **[ENT]** or move the ShuttlePoint knob to the right.
4. Move the ShuttlePoint knob to highlight **Custom** and press **[ENT]** or move the ShuttlePoint knob to the right.
5. Move the ShuttlePoint knob up or down to select the desired item within the groups Marine Settings, Depth Settings, Land Settings, Chart Settings or Underwater Settings and press **[ENT]**. See the above sections for details on selections.

## 12.2 NAVIGATION PAGE

This page is useful to show information when heading to a destination, following a compass heading or navigating to a Mark or a Route. The default page is shown with a Compass Rose, however this can be customized to show a Compass Tape.

1. To change to show the COMPASS TAPE, select the Chart page, press **[MENU]**. Move the ShuttlePoint knob to highlight **SETUP MENU** and press **[ENT]**.
2. Move the ShuttlePoint knob to highlight **GENERAL SETUP** and press **[ENT]** or move the ShuttlePoint knob to the right.
3. Move the ShuttlePoint knob to highlight **WINDOW SETUP** and press **[ENT]** and press **[ENT]** or move the ShuttlePoint knob to the right.
4. Move the ShuttlePoint knob to highlight **NAVIGATION PAGE** and press **[ENT]** and press **[ENT]** or move the ShuttlePoint knob to the right.
5. Move the ShuttlePoint up or down to select **COMPASS TAPE** and press **[ENT]**.
6. Press **[CLR]** or move the ShuttlePoint knob to the right until the Chart page is shown.

### NOTE

The COG heading is computed and supplied to the plotter from the internal GPS or external GPS.

- ① Fix position
- ② Time
- ③ Speed Over Ground
- ④ Course Over Ground
- ⑤ Bearing to Destination
- ⑥ Compass Rose
- ⑦ Time To Go
- ⑧ Distance to Destination



Figure 12.2 - Navigation page with Compass Rose



- ① Fix position
- ② Compass Tape
- ③ Time
- ④ Speed Over Ground
- ⑤ Time To Go
- ⑥ Course Over Ground
- ⑦ Distance to Destination
- ⑧ Bearing to Destination

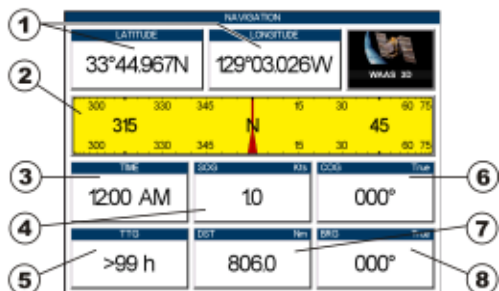

Figure 12.2a - Navigation page with Compass Tape

### 12.3 HIGHWAY PAGE

Shows a 3D view of the vessel travelling through the water when Navigating to a destination point, Mark or following a Route. Press **[ZOOM IN]** or **[ZOOM OUT]** to change the highway scale.

- ① Speed Over Ground
- ② Course over ground
- ③ Bearing
- ④ Highway Display
- ⑤ Highway Scale

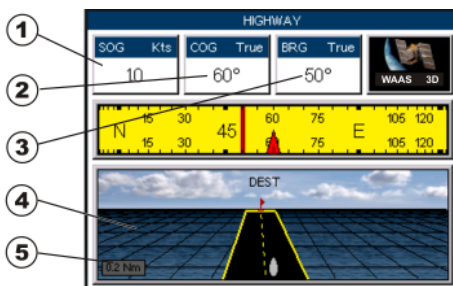

Figure 12.3 - Highway page

### 12.4 CELESTIAL PAGE

The Celestial page contains Tide information critical for safe navigation. This page is also useful for boaters that are concerned about the height of the water under a bridge or by fisherman that wish to know the tide and moon phase of a specific date.

#### Changing date

1. Press **[ENT]** and a popup window will be shown.
2. Moving the ShuttlePoint knob up or down changes the digits and left and right selects the month, day and year.
3. Press **[CLR]** to exit and view the information.

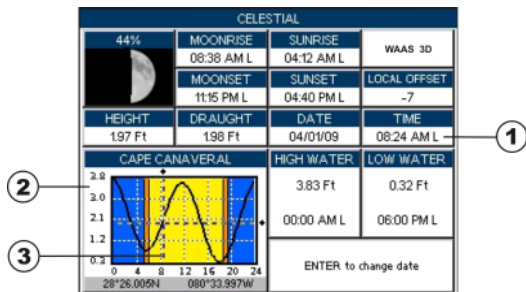

Figure 12.4 - Celestial page

Refer to the image above. The time (1) displayed corresponds to the location of the cross-hair cursor (3) in the Tide Graph (2). Moving the ShuttlePoint knob to the left or right changes the time, moving the ShuttlePoint knob up or down selects the Tide height and draught (draft) on the Tide Graph.

#### NOTE

The **draught** window shows the height of the tide water during a 24hr period of time. For example if the ShuttlePoint knob is pressed up to move the cursor to the top of the Tide Graph this is the High Water Level and if the cursor is moved to the bottom of the Tide Graph the draught will show the Low Water Level.

#### Example 1

You anchor in 15Ft of water (under your keel) at a time of day where the water is the highest (High Water). Let's say the High Water window shows 5Ft and the Low Water window shows 1Ft this means the water under your vessel over a 24 hour period of time could fall 4Ft (High Water - Low Water). With your vessel in 15Ft of water and with a maximum water change of 4Ft during the day, the worst case situation there will be 11Ft of water under your vessel.

## 12.5 GPS STATUS PAGE

This page is used as a reference to see how well the GPS is receiving satellites.

- ① Ship's Coordinates
- ② Date and Time
- ③ Horizontal Dilution of Precision
- ④ Vertical Dilution of Precision
- ⑤ Tracked, but not used, Satellite
- ⑥ Used Satellite

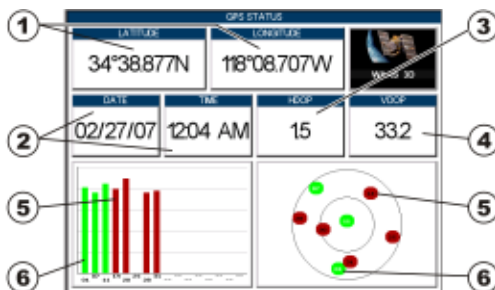

Figure 12.5 - GPS Status page

The WAAS/GPS Icon area may change due to the satellite reception:

**ACQUIRING** : the GPS is trying to receive a valid position fix.

**GPS2D** : The GPS is receiving at least 2 valid Satellites

**GPS3D** : the GPS is receiving at least 3 Satellites.

**WAAS 2D/3D** : the GPS is receiving a 2D or 3D position and the correction from the WAAS Satellite.

**HDOP** : Horizontal Dilution of Precision

**VDOP** : Vertical Dilution of Precision

## 12.5.0 Setup Menu

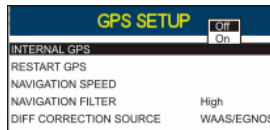

Figure 12.5.0 - Setup menu

From this page it is possible to activate the GPS Setup menu following this procedure:

1. Press **[MENU]**, move the ShuttlePoint knob to enter **GPS STATUS** page and press **[ENT]**.
2. Press and hold **[ENT]**. The GPS SETUP menu appears on the screen. See the following table:

<b>Restart GPS</b>	: Restarts all GPS processes. Once executed, the message "Done" is shown.
<b>Navigation Speed</b>	: Allows setting the Navigation Speed among Low and High. The default setting is High.
<b>Speed Filter</b>	: Allows to resolve erratic speed readings in rough seas. Available values are Off, Low, Medium, High. The default setting is Off.
<b>Differential Correction Source</b>	: Allows setting what kind of Differential Correction will be used by the GPS between WAAS-EGNOS and none. The default setting is WAAS-EGNOS.

3. Move the ShuttlePoint knob to highlight the preferred item and press **[ENT]**.
4. Press **[CLR]** until the menu disappears or an easier method is to move the ShuttlePoint knob to the left until the menu disappears.

### 12.5.1 WAAS/EGNOS Setting

From this page it is possible to disable the WAAS/EGNOS function following this procedure:

1. Press **[MENU]**, move the ShuttlePoint knob to enter **GPS STATUS** page and press **[ENT]**.
2. Press and hold **[ENT]**. The GPS SETUP menu appears on the screen.
3. Move the ShuttlePoint knob to highlight **DIFF CORRECTION SOURCE** and press **[ENT]**.
4. Move the ShuttlePoint knob to highlight **None** (to disable) and press **[ENT]**.
5. Press **[CLR]** until the menu disappears or an easier method is to move the ShuttlePoint knob to the left until the menu disappears.

## 12.6 NMEA DISPLAY PAGE

The GPS Chart Plotter is capable of displaying information in the customizable data windows from external NMEA 0183 devices. Depth sounder, Speed Log with temp, Wind speed and direction, Flux gate compass, and GPS information can be shown in any of the boxes. The default NMEA Display shows 3 windows. When going to a destination, this screen is useful to navigate as to get to the destination keep the Course Over Ground (COG) and Bearing (BRG) figures the same.

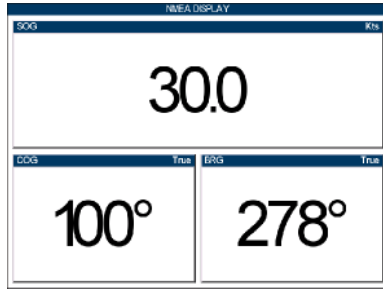

Figure 12.6 - NMEA Display page

The NMEA sentences read from external devices are: BWC, DSC, DSE, GGA, GLL, GSA, GSV, HDG, HDM, HDT, RMC, VHW, VTG, DPT, DBT, MTW, VWR, VWT, TLL, WPL, RTE.

### Changing the NMEA Page Windows

1. Press **[MENU]**, move the ShuttlePoint knob to highlight **NMEA DISPLAY** and press **[ENT]**.

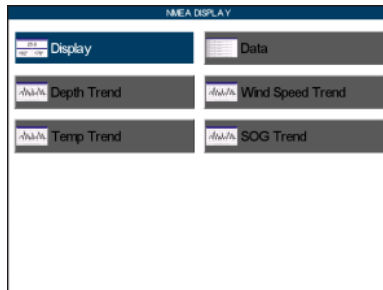

Figure 12.6a - NMEA Display menu

2. Move the ShuttlePoint knob to highlight **DISPLAY** and press **[ENT]**. Press the right most Soft Key twice to show the NMEA Display page (for details refer to previous Par. 3.0.0).
3. To see the 5 different and available pages move the ShuttlePoint knob to the left or right.

## 12.7 NMEA DATA PAGE

The NMEA Data Page is very useful to see if a External device (example: Depth Sounder) is transmitting NMEA sentences to the GPS Chart Plotter. This page can also be used to see if the GPS Chart Plotter NMEA output is being loaded down by a external NMEA device the GPS Chart Plotter is connected to.

Scenario: VHF Radio connected but the Radio is not receiving a GPS Position. Usually the VHF Radio will be connected to the Green and Brown wires.

To check to see if the GPS Chart Plotter is transmitting the sentences:

1. Press **[MENU]**, move the ShuttlePoint knob to highlight **NMEA DISPLAY** and press **[ENT]**.

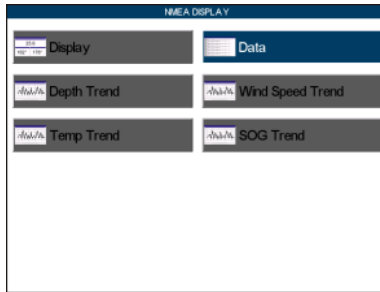

Figure 12.7 - NMEA Display menu

2. Move the ShuttlePoint knob to highlight **DATA** and press **[ENT]**.
3. Connect the BLUE Wire on the GPS Chart Plotter to the junction of the Brown wire and the VHF wire. The display should look similar to the following picture.



Figure 12.7a - NMEA Data page

4. Press **[ENT]** to freeze the data on the display so it is easy to read and understand.
5. Press **[ENT]** again to receive data again.
6. View data from a device connected to another data port, press the **[ZOOM IN]**.

## 12.8 NMEA TREND PAGES

When the GPS Chart Plotter is connected to the Optional FF525 50/200kHz BLACK BOX FISH FINDER or a Digital Depth Sounder, Wind Speed/Direction, Speed Log with Temp with NMEA output the GPS Chart Plotter is capable of show Trends in the data from the device.

To select a NMEA Trend Page:

1. Press **[MENU]**, move the ShuttlePoint knob to highlight **NMEA DISPLAY** and press **[ENT]**.

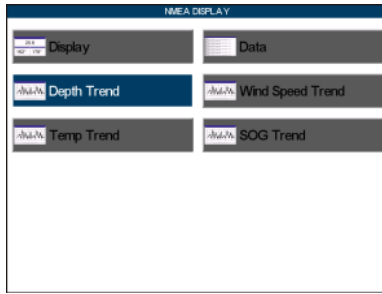

Figure 12.8 - NMEA Display menu

2. Move the ShuttlePoint knob to highlight **DEPTH TREND/WIND SPEED TREND/TEMP TREND/SOG TREND** and press [ENT].

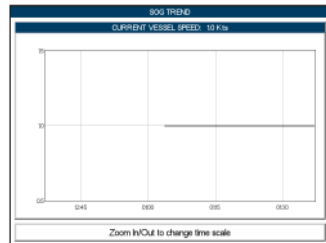
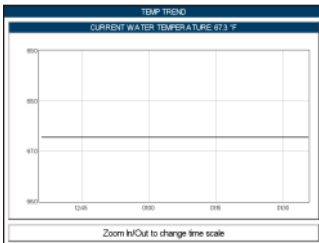
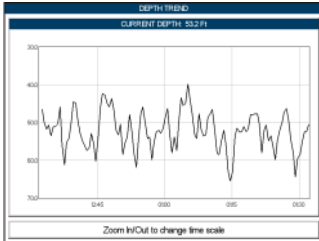

Figure 12.8a - NMEA Trend pages

## 12.9 VHF DIGITAL SELECTIVE CALLING

Digital Selective Calling is a semi-automated method of establishing a VHF radio call. DSC had also been designated as part of the Global Maritime Distress and Safety System (GMDSS).

This new system allow mariners to instantly send a distress call with GPS position (when connected to the transceiver) to the US Coast Guard and other vessels within range of the transmission. DSC will also allow mariners to initiate POSITION Request, POSITION Report calls to or from another vessel equipped with a DSC transceiver.

Compatible VHF Marine Radios with Digital Selective Calling are able to be interfaced with the GPS Chart Plotter which feeds GPS data to the VHF and listens for DSC calls from the VHF. By connecting a few wires between the compatible DSC VHF radios and the GPS Chart Plotter it will receive:



---

# 13. ADVANCED SETTINGS

---

The Advanced Setup menu allows customization of many GPS functions, Alarms and NMEA interfacing.

1. Press **[MENU]**. Move the ShuttlePoint knob to highlight **SETUP MENU** and press **[ENT]**.
2. Move the ShuttlePoint knob to highlight **ADVANCED SETUP** and press **[ENT]** or move the ShuttlePoint knob to the right.

While in this menu you will see many selections which are described in the next sections.

---

## 13.0 INPUT/OUTPUT (NMEA, AIS, RADAR)

---

### 13.0.0 Input

The CP590 has 4 NMEA inputs and 5 NMEA outputs. These Ports may be set up to receive and output the following.

- NMEA0183 - NMEA devices\* set to 4800 Baud (default setting)
- FF525 50/200kHz BLACK BOX FISH FINDER - refer to Fish Finder Owner's Manual
- C-Com - C-Weather refer to Section 15
- Radar - SI-TEX optional Radar refer to Radar Owner's Manual
- AIS 38400 - AIS Receiver, refer to Section 14
- MOBILARM - Mobil-arm receiver, refer to Section 16
- Disabled - allow the port to be disabled.

---

#### NOTE\*

RS232 not opto-isolated electrical interface

---

---

#### NOTE

When a Port is configured, both the Input and Output have the same setting. Port1 is set to Radar, both the Input and Output wires are set to SI-TEX proprietary Radar sentences. This means other devices should not be connected to the Input or Output wires.

---

### 13.0.1 Output

The ports may be setup to output NMEA sentences. The table below shows the default setting each port:

Sentence	Port1	Port2	Port3	Port4	Port5
GLL	On	On	On	On	On
VTG	Off	Off	Off	Off	Off
BWC	Off	Off	Off	Off	Off
WCV	Off	Off	Off	Off	Off
APA	Off	Off	On	Off	Off
APB	Off	Off	On	Off	Off
HDG	Off	Off	Off	Off	Off
BOD	Off	Off	On	Off	Off
XTE	On	On	On	On	On
RMA	Off	Off	Off	Off	Off



RMB	Off	Off	Off	Off	Off
RMC	On	On	On	On	On
GGA	On	On	On	On	On
HSC	Off	Off	Off	Off	Off
DBT	On	Off	Off	Off	Off
DPT	On	Off	Off	Off	Off
MTW	On	Off	Off	Off	Off
VHW	On	Off	Off	Off	Off
GSA	On	Off	Off	Off	Off
GSV	On	Off	Off	Off	Off

## 13.1 NAVIGATE

The Navigate menu allows customization of the Coordinate System (Loran TD's), Chart Datum, Chart Orientation Resolution (angle the vessel has to change before the chart is redrawn) and Static Navigation. See the following table:

<b>Coordinate System</b>	: Selections are: a. TD: Time Difference, based on Loran (see the following Par. 13.1.0) b. UTM: Universal Transverse Mercator Grid c. ddd mm.mmm: Degrees Minutes and Thousands of Minutes d. ddd mm.mm: Degrees Minutes and Hundredths of Minutes e. ddd mm.ss: Degrees Minutes and Seconds
<b>Chart Datum</b>	: Allows selection of Chart Datums. The default Datum is WGS84 as C-MAP BY JEPPESEN cartography has been compiled using the WGS84 Datum. A datum is a mathematical model of the Earth which approximates the shape of the Earth, and enables calculations such as position and area to be carried out in a consistent and accurate manner.
<b>Chart Orientation Resolution</b>	: Sets the angle the vessel has to change before the chart is redrawn. The default setting is 30 degrees. Example: if the vessel is heading 000T at a speed of 25 Knots, the display will redraw: a. In Home mode the GPS Chart Plotter centers the location of the vessel in the center of the display. To keep the vessel in the center of the display the GPS Chart Plotter will occasionally redraw. b. If the vessel changes course greater than 330T or more than 30T the chart will be redrawn.
<b>Static Navigation</b>	: Sets up a threshold for the speed. When the speed received from the positioning device is under that threshold, the GPS Chart Plotter displays zero.

### 13.1.0 Loran TD

The Loran TD selection allows the GPS Chart Plotter to be set up so the user can enter in LORAN TD's directly into the GPS Chart Plotter. After the TD's have been entered, and the user changes to ddd mm.sss (Degrees Minutes and Seconds) the TD's will be converted to Lat / Lon coordinates.

To use the TD Coordinate System the user must setup the Chain and Pair information of the TD's. If you do not know this information, refer to paper charts that show the Chain and Pair information.

<b>ASF1/2</b>	: <b>Additional Secondary phase Factor (TD Coordinate System)</b> Correction to TD1/2 values which can be inserted by the user to take in account the additional signal propagation delay over a mixed land/seawater path compared to on all-seawater path. Normally the user does not enter a ASF value. However for experienced users this function allows entering of signal delay values to fine adjust the calculated position. The user should enter delay values to fine adjust the position calculated.
<b>Alter</b>	: <b>Alternate Solution (TD Coordinate System)</b> Parameter selected by the user that is applied in the conversion of geographical coordinates Lat/Lon to TD values. To be used if the position displayed is roughly not correct.

## 13.2 COMPASS

The GPS Chart Plotter computes compass direction from the constellation of GPS Satellites. For the GPS Chart Plotter to compute direction the vessel must be moving through the water unless connected to an optional Flux Gate Compass sensor. The Compass menu allows the GPS Chart Plotter to customize the following selections:

- Bearings** : Selects between True and Magnetic. When Magnetic bearings is enabled, the GPS Chart Plotter applies the selected Magnetic Variation (Auto or Manual, see next paragraph) to compute Magnetic bearing.
- Variation** : Allows the user to select Auto or Manual. When Auto mode is selected the GPS Chart Plotter computes the offset by the current GPS fixed location. Manual mode allows the user to enter in a magnetic variation that is applied in the True conversion.
- Calibration** : This function allows a user to enter in the offset for areas that the vessel may cruise instead of entering in a manual offset for one location. This offset is useful for cruising vessels or vessels that travel internationally often.

N	N/E	E	S/E	S	S/W	W	N/W
+00°	+00°	+00°	+00°	+00°	+00°	+00°	+00°

Figure 13.2 - Compass Table

## 13.3 ALARMS

This menu is used to select and setup audible and visual Alarms. Available alarms are Arrival, XTE, Depth, Anchor and Grounding Alarm.

- Arrival Alarm** : Alerts when the vessel is approaching a single destination point or when arriving at a leg in a Route. Available selections: 0.00 to 9.99Nm.
- XTE Alarm** : Alerts when the vessel is deviating from a defined course. Available selections: 0.00 to 9.99Nm.
- Depth Alarm** : Alerts when the received depth Value from the optional FF525 (or FF520) 50/200kHz BLACK BOX FISH FINDER or Depth Finder inputting NMEA data into the GPS Chart Plotter is lower than the selected value. Available selections: 0000 to 3000Ft.
- Anchor Alarm** : Alerts when the ships moves off a selected locations by a selected distance. Available selections: 0.00 to 9.99Nm.
- Audible Alarm** : Enables or disables the alarm beep.
- Grounding Alarm** : This function looks ahead of the vessels heading to see if a potential danger exists. When the Grounding Alarm is enabled the GPS Chart Plotter will draw a triangle in front of the vessel on the Chart page showing the area that is being searched as shown below. The depth and range (distance) of the area the GPS Chart Plotter looks ahead for a shallow area can be set using this function.

### NOTES

The Grounding Alarm function is available only if a NT\*/MAX C-CARD is inserted. It also affects the screen redraw speed so we suggest to disable it when not used.

When any of the objects checked are found for the first time, the GPS Chart Plotter shows a pop up window to alert the user of the possible danger. The name of each new dangerous object found is reported in the warning window. In the Grounding Alarm Report page the relative item has a tick marker next to it, to identify the dangerous object currently detected. If in the next search cycle the same objects are found again, the alarm window will not be shown. Instead, if in the next searches the objects found before are no longer detected, their relevant item in the Grounding Alarm Report page is cleared (note that in this case, if the same object type is found again later, the Alarm will be shown). The GPS Chart Plotter shows an icon on the charts that identifies when a Grounding Alarm is detected.



Figure 13.3 - Grounding Alarm

## 13.4 SIMULATION

The built-in Simulator function allows you to become proficient in the use of the GPS Chart Plotter. No current position fix is required because the GPS Chart Plotter simulates position data internally.

<b>Simulation Mode</b>	: Three selections: a. Off - turn the simulation mode off b. On - enable the simulator mode, where the speed and course are adjusted by entering in values in the Course and Speed selection discussed later in this table. c. Route - this selection allows you to navigate to a saved route.
<b>Course</b>	: To start the simulator you can insert the Course value.
<b>Speed</b>	: To start the simulator you can insert the Speed value.
<b>Date</b>	: To start the simulator you can insert the date.
<b>Time</b>	: To start the simulator you can insert the time.
<b>Cursor Control</b>	: Enables (On)/disables (Off) the cursor control. Moving the ShuttlePoint knob up or down will change the SOG and left or right will change the COG of the simulated vessel.
<b>Demo Mode</b>	: In Demo mode the GPS Chart Plotter automatically places a Destination point on the Chart page and simulates navigation to the point. Also, the active page changes automatically every 10 seconds. The pages are shown in the following order: Start-up screen, GPS Status, Chart/Compass tape, Chart/Fish Finder, Full page Fish Finder, Full page Radar, Navigation, Highway, Celestial, NMEA. Once the Demo mode is enabled, pressing any key it is possible to temporarily exit and returns to GPS Chart Plotter normal operation, but if you do not touch any key for 30 seconds Demo mode re-starts.

### 13.4.0 Navigating a Route in Simulation mode

This selection allows you to navigate to a saved Route to see how data windows on the Chart page and how the Navigation and Highway pages operate.

1. Create a Route. Refer to Par. 9.0 Route.
2. Press **[MENU]**, move the ShuttlePoint knob to highlight **SETUP MENU** and press **[ENT]**.
3. Move the ShuttlePoint knob down to highlight **ADVANCED SETUP**, then press **[ENT]**.
4. Move the ShuttlePoint knob to highlight **SIMULATION** and press **[ENT]**.
5. Move the ShuttlePoint knob to highlight **SIMULATION MODE** and press **[ENT]** to show a popup window.
6. Move the ShuttlePoint knob to highlight **ROUTE** and press **[ENT]** which will show a popup window with the Route(s) that are stored in the GPS Chart Plotter's memory.
7. Highlight the desired Route and press **[ENT]**.
8. Move the ShuttlePoint knob to highlight **SPEED** and press **[ENT]**.
9. Enter in the speed you want to vessel to travel at in simulation mode, by moving the

- ShuttlePoint knob left or right to select a number and up or down to change a number.
10. When the speed is adjusted, press **[ENT]**.
  11. Press **[CLR]** multiple times until the Chart page is shown.

## 13.5 DSC POLLING

---

This menu is used to enable or disable features related to the DSC function.

---

<b>Auto Position</b>	: Selects between Manual or Auto. See also the Par. 12.8.1. When Auto Position item is set to <b>Manual</b> and receiving the Position Request, the Position Request pop-up window is not displayed and the cursor does not move to the position of the received Position Request data point. Otherwise when Auto Position item is set to <b>Auto</b> , the GPS chart plotter works as follows: <ol style="list-style-type: none"><li>1 : when receiving the Position Request, the Position Request popup window is displayed;</li><li>2 : when selecting <b>VIEW ON CHART</b>, the position is indicated on the chart marked with "P". The cursor is moved to the point "P" and shows the point in the center of the screen;</li><li>3 : when moving the cursor from "P", the location can be confirmed. At this time, the same MMSI Position Request data that were received before are remaining and displayed.</li></ol>
<b>Auto Info</b>	: Enables or disables the Auto Info. This selection is available only when Auto Position is set to Manual. If Auto Info is set to On, when receiving the Position Request it is possible to center the cursor over the top of the Position Request icon and show the Position Request popup window

---

---

## 14. AIS

---

AIS is an Automatic Identification System. It has been introduced to improve the safety of navigation by assisting in the efficient operation of ship-to-ship location reporting and VTS applications. The system should enable operators to obtain information from the ship automatically, requiring a minimum of involvement of ship's personnel, and should have a high level of availability. AIS transponders installed on IMO vessels use VHF frequencies to:

- Transmit details of their own vessel
- Receive details from other vessels or navigation aids within VHF range.

STANDARD HORIZON GPS Chart Plotters are able to display AIS target (for collision avoidance) on the Chart Page and AIS list pages when connected to a AIS receiver (GX2100 or GX2150 STANDARD HORIZON VHF/AIS transceiver) or transponders which output NMEA 0183 VDM sentence at 38400 or 4800 baud. The Chart Plotters are able to show targets from both Class A (commercial) and Class B targets.

---

### 14.0 SYSTEM DEFINITIONS

---

- **Target:** It is a vessel equipped with AIS. Information about the targets is being received by AIS Receiver and displayed on the screen.
- **CPA :** Closest Point of Approach is the closest distance that will be achieved between your vessel and the tracked target, based on your vessel's speed and direction and the target's speed and direction.
- **CPA Limit:** This is the distance from your vessel that a target may reach before a target is deemed a threat.
- **CPA Alarm:** Occurs if CPA is less or equal to CPA Limit. This test is done for active targets only.
- **TCPA:** Time to closest Point of Approach is the time remaining until the CPA will occur.
- **TCPA Limit:** This is the time remaining before the CPA is reached.
- **TCPA Alarm:** Occurs if TCPA is less or equal to TCPA Limit. This test is done for active targets only and if CPA value is less or equal to CPA Limit.
- **Radio Call Sign:** International call sign assigned to vessel, often used on voice radio.
- **Name:** Name of ship, 20 characters.
- **MMSI:** Maritime Mobile Service Identity.
- **MMSI number:** A unique 9 digit number that is assigned to a DSC radio station. It primarily registers the boat information in the U.S. Coast Guard's national distress database for use in emergency situations.
- **Active Target:** Target located within the Activation Range. Active target is represented by oriented triangle with COG and Heading vectors. Rate of turn may also be displayed.
- **Dangerous Target:** Target detected by CPA or TCPA Alarm. Dangerous target is Active Target by definition. For better visibility Dangerous Target symbol is flashing.
- **Sleeping Target:** Target located outside the Activation Range. Sleeping target is represented by a small oriented triangle.
- **Lost Target:** When the AIS info is not received from that vessel for 3.5 minutes. The presentation will be a flashing black triangle with a cross through.
- **Activation Range:** Range around your boat where targets become active. AIS target

become active within this range. Activation Range should be greater than CPA Limit by definition.

NOTE

A target is removed from the screen if data is not received for 10 minutes.  
 The maximum number of tracked Class A or B targets is 200.  
 This information is updated every 3 seconds to 6 minutes depending on speed and rate of turn, enabling the track of the vessels in range to be plotted.





TARGET STATUS	DESCRIPTION	SYMBOL
ACTIVE TARGET	Target located within the Activation Range.	
DANGEROUS TARGET	Target detected by CPA or TCPA Alarm. Dangerous Target is Active Target by definition.	
SLEEPING TARGET	Target located outside the Activation Range.	
LOST TARGET	Ais info is not received from that vessel for 3.5 minutes.	

Figure 14.0 - AIS Symbols

## 14.1 MENU

To configure the GPS Chart Plotter to receive AIS data, follow the procedure:

1. Press **[MENU]**, move the ShuttlePoint knob to highlight **SETUP MENU** and press **[ENT]**.
2. Move the ShuttlePoint knob to highlight **AIS SETUP** and press **[ENT]** or move the ShuttlePoint knob to the right. The new AIS menu appears on the screen. The available functions are described in the following table.

<b>Display</b>	: Turns the display of AIS Targets overlay on the cartography On or Off.
<b>Activation Range</b>	: Defines the range from the fix within which the AIS Target becomes active. The values allowed are from 0.1 to 20 Nm.
<b>CPA Alarm</b>	: Turns On or Off the alarm.
<b>CPA Limit</b>	: The values allowed are from 0.1 to 10 Nm.
<b>TCPA Alarm</b>	: Turns On or Off the alarm.
<b>TCPA Limit</b>	: The values allowed are from 1 to 30 Min.

## 14.2 AIS SETUP

Refer to Connections/PWR AUX 1 NMEA connections section, see Par. 2.3.2.0.

## 14.3 QUICK INFO ON AIS TARGET

By placing the cursor over a AIS Target icon using the ShuttlePoint knob, the following information is displayed (see the following picture):

- Vessel Name
- MMSI number
- Radio Call Sign
- SOG
- COG
- CPA and TCPA values

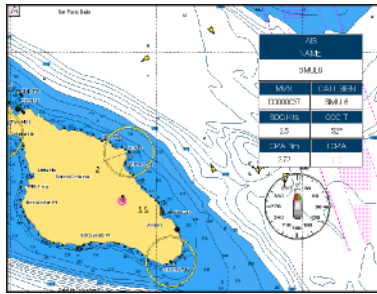

Figure 14.3 - Quick Info on AIS

**NOTE**

The selected AIS Target icon is surrounded by a square frame when user places the cursor over the icon.

**14.4 LIST**

It is possible to show the AIS List page that show basic information of the Target ship with the ability to select a Target ship and locate it on the chart. Follow the procedure:

1. Press **[MENU]**, move the ShuttlePoint knob to highlight **USER POINTS** and press **[ENT]**.
2. Move the ShuttlePoint knob to highlight **AIS LIST** and press **[ENT]**.

AIS LIST							
NAME	CALL SIGN	MMSI	IMO NUMBER	COURSE	SPEED	HEADING	STATUS
SHUTTLE	SHUTTLE	000000000	000000000	95	88°	076	225
SHUTTLE	SHUTTLE	000000000	000000000	25	57°	HE	
SHUTTLE	SHUTTLE	000000000	000000000	85	90°		
SHUTTLE	SHUTTLE	000000000	000000000	44	98°	???	???
SHUTTLE	SHUTTLE	000000000	000000000	25	7°	???	???
SHUTTLE	SHUTTLE	000000000	000000000	0	240°	???	???
SHUTTLE	SHUTTLE	000000000	000000000	25	98°	???	???
SHUTTLE	SHUTTLE	000000000	000000000	0	98°	???	???
SHUTTLE	SHUTTLE	000000000	000000000	31	52°	???	???
SHUTTLE	SHUTTLE	000000000	000000000	0	73°	???	???

Figure 14.4 - AIS List page

3. Move the ShuttlePoint knob up or down to select the Target and scroll the page up or down. Press **[ENT]** exits the page and shows the Target ship on the Chart page along with the current position of the GPS Chart Plotter.

**14.5 AIS TARGET COLORS**

The received AIS Targets are shown in color. The color depicts the type of AIS ship shown on the Chart Page. Refer to following table.

TYPE OF SHIP	GRAPHICAL PRESENTATION
Undefined	▲ (yellow)
Fishing	△ (white)
Pleasure Craft	▲ (light green)
Tanker	▲ (dark blue)
Pilot Vessel	▲ (light gray)
SAR	▲ (black)
Tug	▲ (pale green)
Port tenders	▲ (brown)
Vessels with antipollution facilities or equipment	▲ (light blu)
Low enforcement vessels	▲ (light red)
Medical transport	▲ (dark green)
Vessels according to Resolution N° 18 (Mob-83)	▲ (cyan)
HSC	▲ (red)
Passenger ship	▲ (magenta)
Cargo ship	▲ (dark gray)

Figure 14.5 - Color AIS Targets



---

## 15. C-WEATHER SERVICE

---

C-Weather is a **free** service available on the CP590. C-Weather service gives excellent coverage for the whole World. Weather forecasts are based on data received from the leading meteorological centers. This data is processed by Jeppesen server and made available via INTERNET connection to be transferred by using the C-MAP BY JEPPESEN PC-Planner Windows Application. Then the weather data can be saved into a User C-CARD to be loaded by the GPS Chart Plotter (see Par. 15.0.1).

**Features:** 5-day weather forecast updated every 6 hours; coverage of 180x180 Nm with information frequency of 0.5° Lat/Lon; wind direction and strength; wave height and direction; ground temperature; level of humidity; visibility in miles.







Data Type	Display
WIND (Speed & Dir)	- 0 →
WAVE Height & Dir	- 1 →
TEMPERATURE	18°
HUMIDITY (%)	30
VISIBILITY	20
WEATHER TYPE: Sun	
WEATHER TYPE: Rain	
WEATHER TYPE: Fog	
WEATHER TYPE: Snow	
WEATHER TYPE: Clouds	
WEATHER TYPE: Partly Cloudy	
WEATHER TYPE: Thunderstorm	

Figure 15 - Weather data package

---

### 15.0 C-WEATHER SERVICE MENU

---

To select the menu:

1. Press **[MENU]**, move the ShuttlePoint knob to highlight **SETUP MENU** and press **[ENT]**.
2. Move the ShuttlePoint knob to highlight **C-WEATHER SERVICE** and press **[ENT]** or move the ShuttlePoint knob to the right.

The C-Weather menu is shown on the screen, the items are described in the following paragraphs.

#### 15.0.0 Download

Allows to connect the software to the weather server and to download weather data directly via C-COM.

---

**Select Country To Call** : Allows the selection of the country to call. The whole telephone number set is automatically updated after every download.

---

**SIM Pin** : Allows inserting of the Pin of the SIM.

---

**Download Area** : Allows the weather download: a squared grey area, where the weather data will be downloaded, is centered on cursor position. See the following picture.

---

Area of coverage of downloaded data is located by default with its center on the cursor position

Indicates the LAT/LON position of the cursor



Cursor is locked to the gray area. Moving the cursor also moves the gray area allowing locating it over the area where the user wants to download the forecast.

Figure 15.0.0 - Example of Download Area

**Press [Load] to activate the C-Weather Download:** the whole data package (see the previous "Weather data package" table) are downloaded. **[Stop]** allows to interrupt the data download. At the end of the operation press **[Exit]** to close the window.

### 15.0.1 Copy From Memory CARD

Allows the whole data package C-Weather loading from the User C-CARD.

### 15.0.2 Forecast

Allows selecting the Layer of specific weather data to be displayed on the screen and to change date and time of the forecast preview. The following functions are available:

- **Panning:** default usage of the cursor key is the normal panning function.
- **Zoom in/out:** zoom in/out functions are allowed as usual by using **[ZOOM IN]/[ZOOM OUT]**.
- **Set of date and time:** to modify date and time. Press **[DATE/TIME]**.
- **Data Type:** to cycle of the weather data among the following layers: Wind, Wave Data, Weather, Humidity, Temperature, Visibility. Press **[TYPE]**.
- **Exit:** to exit the Weather mode. Press the **[Exit]**.

### 15.0.3 Real Time View

The following selections are available:

- **Real Time View On:** the data is shown (the area of the download) at the current date and time (received from the GPS).
- **Real Time View Off:** the Weather data is not displayed.

The layer displayed is the one selected into the previous menu item.

### 15.0.4 Type of Data

Allows selecting the type of data among: Wind, Wave Data, Weather, Humidity, Temperature, Visibility.

---

## 16. MOBILARM

---

The MOBILARM is an automated crew monitoring system dedicated to monitoring onboard crew by maintaining a constant link between the crew member and the boat. When a man overboard event happens, an automatic alarm is sounded, and the vessels position is shown on the Standard Horizon GPS Chart Plotter.

### 16.0 MOBILARM-GPS CHART PLOTTER CONNECTION

---

Connect the MOBILARM system to one of the Ports on the Standard Horizon GPS Chart Plotter. Refer to Par. 2.3.2.0 "PWR & ACC 1 Cable" and "NMEA Connections" and MOBILARM Owner's Manuals for connections.

#### Connection Example

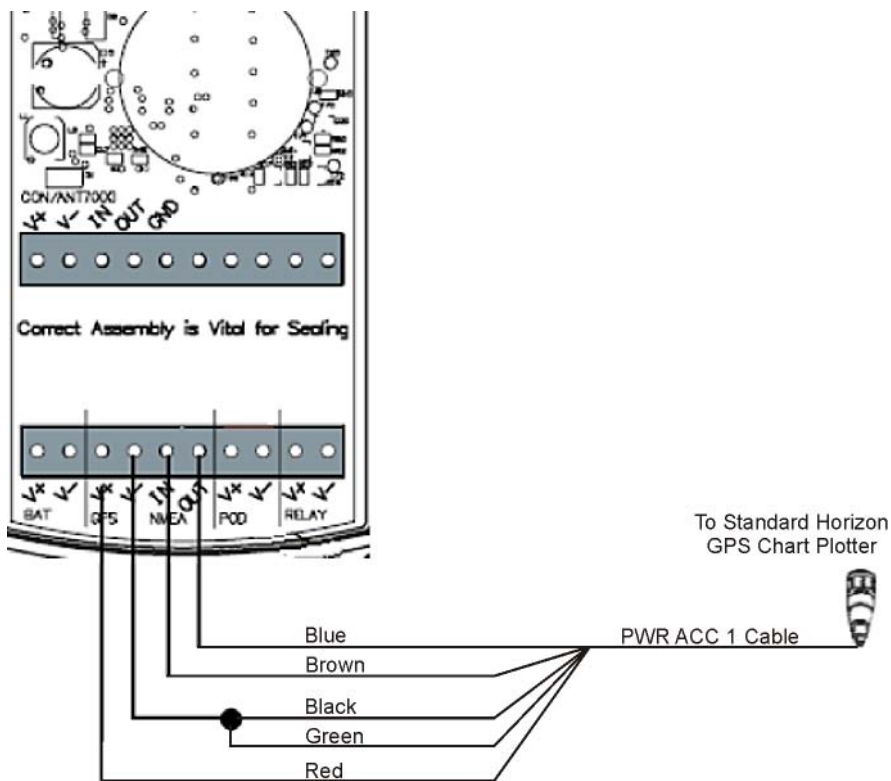

Figure 16.0 - Connection Example

## Port 1 Example

Chart Plotter	MOBILARM
Blue	NMEA Out
Brown	NMEA In
Red	GPS V+
Black	GPS V-

### NOTE

Refer to the Figure 16.0, the Blue and Brown wires are from Port 1. If these wires are being used to connect to another NMEA device, choose another wire pair and configure the port associated with the wires.

## 16.1 SOFTWARE SETUP

After the Port has been chosen and connected in Par. 16.0, the GPS Chart Plotter must be setup to communicate with the MOBILARM.

Use the steps below to set up the Port the MOBILARM is connected to the GPS Chart Plotter.

1. Select the Chart Page.
2. Press **[MENU]**, move the ShuttlePoint knob to highlight **SETUP MENU** and press **[ENT]**.
3. Move the ShuttlePoint knob to highlight **ADVANCED SETUP** and press **[ENT]** or move the ShuttlePoint knob to the right.
4. Move the ShuttlePoint knob to highlight **IN/OUT CONNECTIONS** and press **[ENT]** or move the ShuttlePoint knob to the right.
5. Move the ShuttlePoint knob to highlight any input port and press **[ENT]** or move the ShuttlePoint knob to the right.
6. Move the ShuttlePoint knob up/down to select **MOBILARM** and press **[ENT]** or move the ShuttlePoint knob to the right. Selecting MOBILARM format, activates the function.
7. Press **[CLR]** or move the ShuttlePoint knob to the left until the Chart page is shown.

The GPS Chart Plotter continuously verifies the communication status with MOBILARM PTX (Personal Transponder) device. When a signal from the PTX is lost for more than one minute, the MOBILARM sends a NMEA message to the GPS Chart Plotter which will produce an alarm and a popup window will be shown on Standard Horizon GPS Chart Plotter.

## 16.2 MOBILARM STATUS

To confirm the status of the MOBILARM, select the About page:

1. Select the Chart Page.
2. Press **[MENU]** two times. Move the ShuttlePoint knob to highlight **About...** and press **[ENT]**.

On the About page you can see the status of the MOBILARM, below are the possible messages.

- a. **Function not Activated** : MOBILARM has not been setup in the I/O Connections menu. Refer to Par. 16.1.
- b. **Not connected/detected** : possible wiring problem, confirm wires are correct connected from the GPS Chart Plotter to the MOBILARM device.
- c. **Connected** : the communication with MOBILARM device is Ok.
- d. **Signal Lost** : the MOBILARM has been connected in the past, however no signal is being detected from the MOBILARM. Check wire connections from the GPS Chart Plotter to the MOBILARM.

- e. **No valid GPS position** : the communication with MOBILARM device is Ok, but the GPS position fix is not received from the GPS Chart Plotter.

See the following example of About page:

① MOBILARM status Information

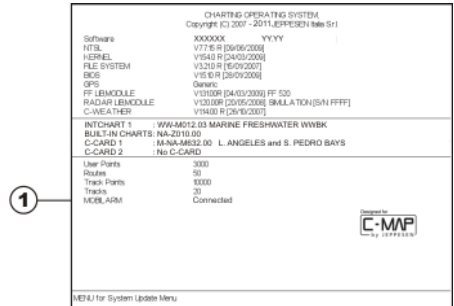

Figure 16.2 - Example of About page with MOBILARM information

### 16.3 MOBILARM PTX

A PTX is the Personal Transponder device that is worn by the crew. If a crew member falls in the water the MOBILARM sends a signal to the GPS Chart Plotter which creates and displays a PTX icon on the Chart page.

#### 16.3.0 MOBILARM MOB alert is received

When crew member falls in the water, the MOBILARM sends a signal to the GPS Chart Plotter which creates and displays a PTX MOB icon on the Chart page.



Figure 16.3.0 - The PTX icon

On the GPS Chart Plotter all menus and/or pages are closed and the chart is centered on the PTX MOB received position. A Audible Alarm is heard and a popup warning window appears to notify that a PTX has been received:

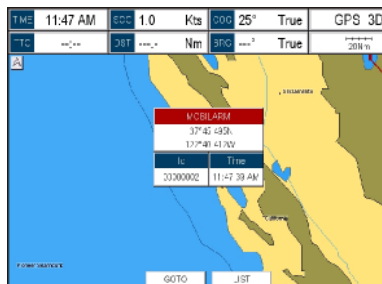

Figure 16.3.0a - Example of PTX warning window

It is possible to Goto (navigate) to the received MOBILARM PTX position (see Par. 16.4.1) or open the MOBILARM Alarm Status List page (see Par. 16.4.2). Selecting Goto or Alarm Status List will mute the Audible Alarm.

## NOTE

When the same PTX is received again:

- If the received PTX is not the active one, the user must confirm to navigate to it.
- If the received PTX is the active one, navigation data is updated. The PTX icon appears at the new position and a popup warning window appears.

## 16.4 PLACING CURSOR ON THE PTX ICON

Moving the ShuttlePoint knob so the cursor is over the PTX icon on the Chart page will show an information window and allow you to Goto the location of the PTX, delete the PTX icon or show the Alarm Status list as shown below.



Figure 16.4 - Example of PTX information window

### 16.4.0 Delete PTX

The Delete PTX function permanently removes the selected PTX from the MOBILARM Alarm Status List and from the Chart page. Using the ShuttlePoint knob, move the cursor over the PTX icon and then press **[DELETE]**. A warning popup window will be shown. Select **YES** and press **[ENT]**.

### 16.4.1 Goto PTX

When Goto is selected on the GPS Chart Plotter, navigation will start to the PTX icon location. After the GPS Chart Plotter has received a PTX MOB alarm, using the ShuttlePoint knob move the cursor over the PTX to navigate to and then two Soft Keys under the display will be shown:

- [Goto]**, when pressed will start navigating to the PTX MOB location
- [List]**, when pressed will show the MOBILARM Alarm Status List page. Refer to Par. 2.4.2 for Alarm Status List.

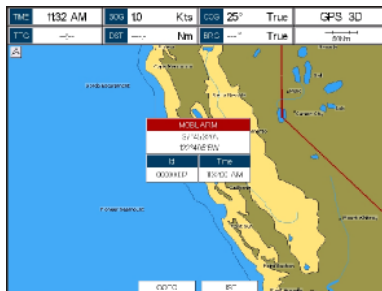

Figure 16.4.1 - Example of Goto PTX

If the navigation is set to the selected PTX icon, to terminate the navigation press [**StopGoto**].

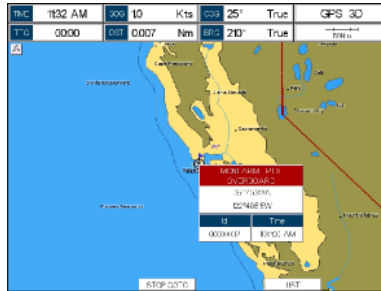

Figure 16.4.1a - Example of Stop Goto PTX

## 16.4.2 The MOBILARM Alarm Status List

The MOBILARM Alarm Status List shows the list of all PTX that the GPS Chart Plotter has received an alarm from. To review the page:

1. Select the Chart page.
2. Press [**MENU**] to show the Main menu.
3. Move the ShuttlePoint knob to highlight **USER POINTS** and press [**ENT**].
4. Move the ShuttlePoint knob to highlight **MOBILARM** and press [**ENT**].

- ① PTX number
- ② Time the PTX alarm was received
- ③ PTX position
- ④ PTX status

PTX number	Time	Position	Status
00000001	12:07:20 AM	113°11.000W 49°06.000N	Recovered
00000002	03:45:14 PM	213°22.120W 20°01.000N	Recovered
00000003	10:31:24 PM	306°04.015W 79°56.300N	Recovered

Figure 16.4.2 - Example of MOBILARM PTX List page

This page allows you to:

<b>GOTO</b>	Activates navigation to the selected PTX. Once the navigation has been activated, close all menus/data pages (if open) and center the chart selected PTX.
<b>DELETE</b>	Deletes the selected PTX.
<b>SHOW</b>	Centers the chart on the selected PTX.
<b>SHOW ALL</b>	Selects the best chart scale to see PTX icons on the chart at the same time.

---

## 17. TROUBLESHOOTING

---

**The GPS Chart Plotter does not turn On.** The voltage or the polarity may not be correct. Make sure that the correct voltage (10-35 volt dc) is present. Check also that the polarity is correct.

**The GPS Chart Plotter does not get a valid fix.** The external WAAS GPS Antenna may not be in a open sky position or the antenna cable may not be properly connected. Make sure that no metal obstacle (solar panel about the plotter) is placed around the chart plotter (or external antenna when connected) acting as a shield for the antenna and disconnect and connect again the antenna cable to the GPS Chart Plotter. If, after 15 minutes, the GPS Chart Plotter does not get the fix, turn it Off and On again.

**The GPS Chart Plotter does not turn Off.** The GPS Chart Plotter may be in an unpredictable status. If, after pressing [PWR] (for at least 3 seconds) the GPS Chart Plotter does not turn Off, turn Off the voltage.

**The GPS Chart Plotter screen becomes very dark after a long exposure to direct sunlight.** The internal temperature is very high. Protect the GPS Chart Plotter from direct sunlight.

**The GPS Chart Plotter does not respond to any command.** The GPS Chart Plotter may be in an unpredictable status. Try to turn Off, and then turn On. If the problem persists, reset the RAM or remove power from the battery.

**The location of my fix is not shown correctly on the Chart page.** Please report to C-MAP USA (800/424-2627) the Latitude & Longitude of your vessels position, the position where you think your vessels should be and details of the cartography such as "Compilation scale", "Notice to mariners" and "Horizontal datum" (which can be seen by selecting the Chart page, press [INFO], move the ShuttlePoint knob to **Data Source** and press [ENT]).

**After storing the Chart Plotter over the winter, It takes a long time to receive a fix.** This is usually caused by the internal rechargeable memory battery from becoming low which could cause the Internal RAM memory to become corrupted. To solve this issue, perform a RAM clear (refer to Section 18).

### NOTE

---

After performing a RAM Clear all Marks, Routes and tracks will be erased. To back up these points refer to Section 11 for details.

---



---

## 18. TECHNICAL TESTS

---

### 18.0 SYSTEM TEST

---

If you have connected your GPS Chart Plotter according to the instructions, and chosen the proper menu selection for your device, and are still having problems with your GPS Chart Plotter, the extended auto-test should help determine the problem. Make sure the GPS Chart Plotter is turned Off. While pressing and holding **[CLR]**, turn the GPS Chart Plotter On. A new menu will appear on the display:

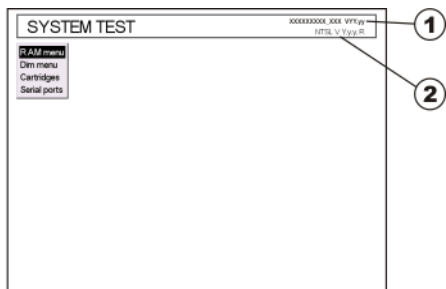

① Software name and version

② NT+ Software Library version

Figure 18.0 - System Test

Use the ShuttlePoint knob to select the desired test. Choose the test, press **[ENT]**. To exit from any submenu press **[CLR]**. To exit from the System Test turn Off the GPS Chart Plotter.

#### 18.0.0 RAM Menu (reset)

##### NOTE

After performing a RAM Clear all Marks, Routes and tracks will be erased. To back up these points refer to Section 11 for details.

This test verifies the integrity of the memories and if desired during this test all the internal memory can be erased and the default setting restored.

#### **RAM Clear**

To clear internal memory. If the GPS Chart Plotter exhibits unusual operations, or appears to be malfunctioning, it may be possible to correct the problem by clearing RAM.

This operation will erase all Marks, Routes, stored Track plots and Destinations. It will also return all selections (Input Data Format, Autopilot selection, etc.) to original default values. To confirm clear RAM press **[ENT]** again (but if at this time you do not wish to clear RAM press **[CLR]**).

#### 18.0.1 DIM Menu

To select the desired value for brightness and keypad light.

#### **Contrast**

Each time you move the ShuttlePoint knob to right, the screen will decrease brightness, move it to the left to increase brightness.

## Backlight

The second option allows to set the backlight. Operates in similar mode as Contrast.

### 18.0.2 Cartridges (used by Standard Horizon Technicians)

To check the C-CARD and its connector.

#### Internal Data Base Test

To test the WorldWideBackground.

#### C-CARD Test

To test the C-CARD. There are the possible situations:

1. if there is a C-CARD inserted in the slot and there is not a malfunction, the name of the C-CARD zone and the message "OK" are shown.
2. if there is a C-CARD inserted in the slot, but it is a defective C-CARD, the name of the C-CARD zone and the message "Faulty" are shown.
3. if there is not any C-CARD inserted in the slot, the message "not present" is shown.
4. if there is a User C-CARD inserted in the slot, the message **USER C-CARD** is shown.

#### C-CARD Connector

Indicates if there is a malfunction in the connector.

### 18.0.3 Serial Ports (used by Standard Horizon Technicians)

If you are having problems receiving data from the position-finding instrument, this test should help determine the problem.

#### Change Parameters

To change the parameters of the serial interface. This menu allows to select the **Port** (Signal Source) between PORT 1, PORT 2, PORT 3; the **Baud Rate** between 300, 1200, 2400, 4800, 9600, 38400, 115200; the **Data Bits** (Word Length) between 7 or 8, the **Parity** between even, odd or none, the **Stop Bits** between 1 or 2. Default settings are: Port = PORT 2, Baud Rate = 4800, Data Bits = 8, Parity = none, Stop Bits = 1.

#### Input Data Display

To allow the GPS Chart Plotter to act as a computer terminal and display the incoming data exactly as it is received.

If the data displayed on the screen is unrecognizable, you may have selected the wrong input parameters for your particular receiver, for example, Baud Rate 9600 instead of Baud Rate 4800. Check your receiver manual to be sure that you have selected the proper parameter. If the screen is blank, you may have a broken connection, and no data is being received or you may have connected the device to the other input port.

Use **[ZOOM IN]** to stop (or continue after pause) data displaying, **[ENT]** to show data in hex or ASCII mode (normal or small) and **[CLR]** to exit.

#### Loop-Back Test

This is a special test done during the production phase to check the serial ports integrity. This function is only required by Standard Horizon.

## 19. SPECIFICATIONS

<b>Power Consumption</b>	: 1.5A max @12V WITH EXTERNAL GPS and TWO VIDEOCAM CONNECTED
<b>Power supply</b>	: 10-35 Volt DC
<b>Interface</b>	: Input/Output Interface NMEA-0183
<b>Display</b>	: TFT Color LCD ( <i>active area 12"</i> ) sunviewable technology
<b>Display Resolution</b>	: 800 x 600 pixels
<b>Cartography</b>	: <b>C-MAP BY JEPPESEN NT*/MAX C-CARD</b>
<b>Operating Temperature range</b>	: 32°F/+131°F (0°C/+55°C)
<b>Storage Temperature</b>	: -4°F/+158°F (-20°C/+70°C)
<b>Keyboard</b>	: Silicon rubber, backlight
<b>Weight (without bracket)</b>	: 6,6 lbs (3000 gr)
<b>User Points (Marks/Waypoints)</b>	: 3000
<b>Routes</b>	: 100 (max 50 Waypoints each)
<b>Track Points</b>	: 10000 (recordable in 20 Tracks)
<b>NMEA Output sentences</b>	: GLL, VTG, BWC, WCV, APA, APB, HDG, BOD, XTE, RMA, RMB, RMC, GGA, HSC, DBT, DPT, MTW, VHW, GSA, GSV
<b>NMEA Input sentences</b>	: BWC, DBT, DPT, DSC, DSE, GGA, GLL, GSA, GSV HDG, HDM, HDT, MTW, MWD, MWV, PCMPA, PCMPD, PJRCD, PJRCF, PKODG, RMC, RTE, TLL, VDM, VHW, VTG, VWR, VWT, WPL

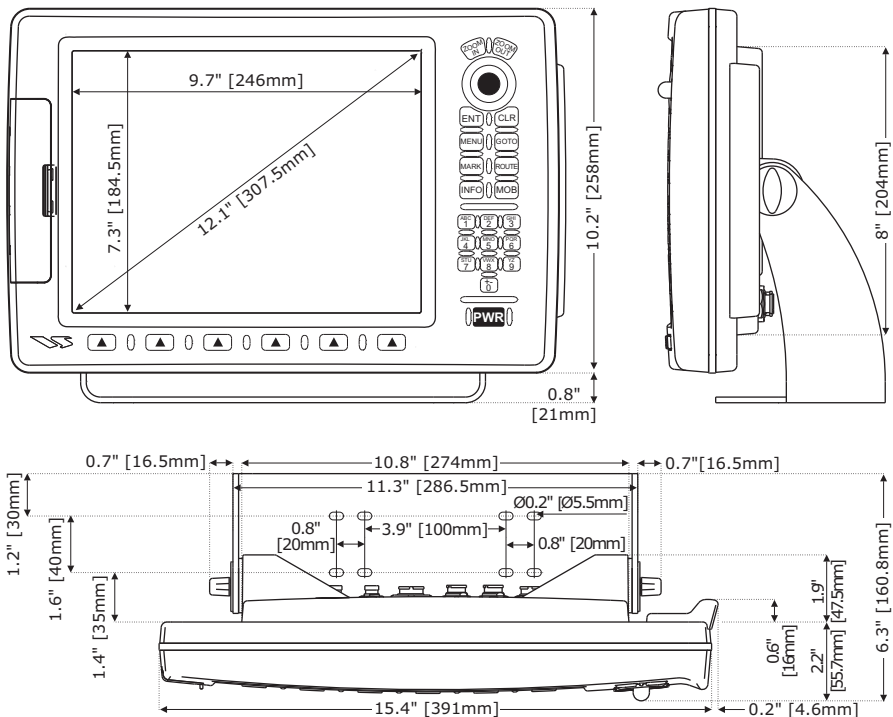

Figure 19 - CP590 Dimensions [inch/mm]

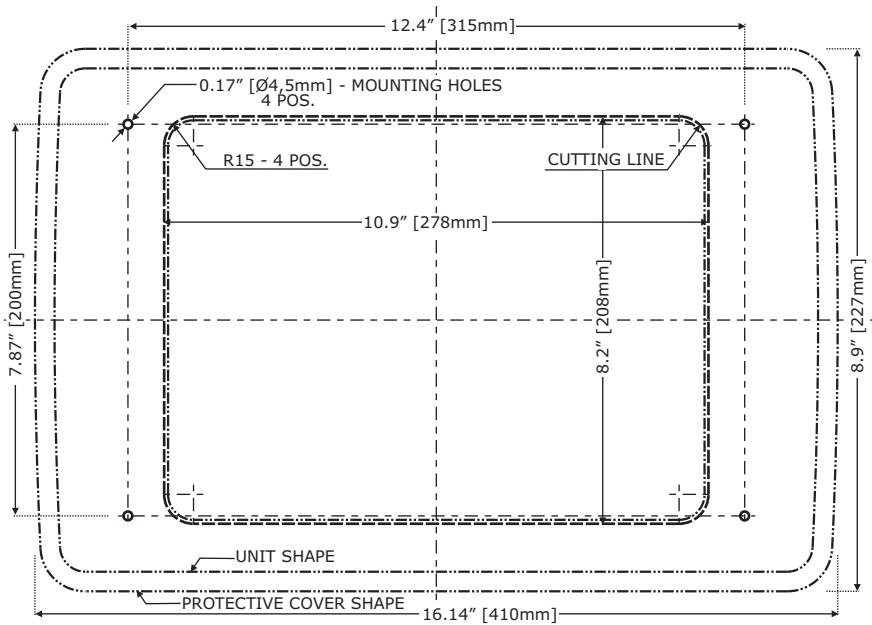

Figure 19a - CP590 Flush Mount cutout (Dimensions are in mm)

## 19.0 OPTIONAL FF525 FISH FINDER SPECIFICATIONS

<b>Power Output</b>	: 600W or 1kW depending on connected transducer
Frequency	: 50 and 200kHz
Minimum Depth	: 5Ft at 50kHz, 2.5Ft at 200kHz
Maximum Depth	: 1500Ft at 50kHz, 700Ft at 200kHz
Airmar X-DUCER ID	: Must use Standard Horizon transducers
Advanced Digital Signal Processing	
Speed & Temperature Sensor (if available on transducer)	
Alarms (shallow water, depth, Fish, temp)	
Trip Log, Fish Symbols	
STC, Interference Rejection, Automatic noise reduction	
A-Scope, White Line, Zoom x2/x4	
Auto range/gain/frequency/shift/ping rate	
16/256 colors display user selectable	

## 19.1 OPTIONAL WAAS GPS RECEIVER SPECIFICATIONS

This optional WAAS GPS Receiver is based on a ultimate GPS engine that delivers accuracy better than three meters by decoding the GPS correction signals from the satellite-based WAAS (*Wide Area Augmentation System*). The GPS engine, interface electronics and the passive antenna are enclosed inside the waterproof plastic housing. This provides advanced state of the art GPS performance in an easy to use package.

### Physical Characteristics

Color	Ivory white
Dimensions	97mm in diameter x 32mm in height (flush mounted) or 61,5mm on flag-pole mount
Weight (without cable)	0,35 lb (160 g)
Cable	white 15 meter 8x28AWG cable with 6 pins female connector

### Electrical Characteristics

Input Voltage	10 Vdc to 35 Vdc unregulated
Input Current	0.8 Wmax
GPS Receiver Sensitivity	Tracking, Navigation : -160 dBm Acquisition, Reacquisition : -160 dBm Cold Starts : -145 dBm

### GPS Performance

GNSS Systems	GPS : L1 C/A GALILEO : L1 SBAS : WAAS (North America), EGNOS (Europe), MSAS (Asia), GAGAN (Indian)
Geodetic Datum	WGS84
Channels	32 + 18

### Acquisition Time

Reacquisition	< 1 second
Hot Start	1 second
Warm Start	29 seconds
Cold Start	29 seconds

### Accuracy

GPS	< 10 Feet
with SBAS	< 2.0m

### NMEA Output

Messages	GGA, RMC, GSA, GSV, TXT
----------	-------------------------

---

## 20. APPENDIX: TERMS

---

**ALT** (Altitude) – Shows the Altitude of the GPS Antenna on the mean sea level. It is received from GPS, sentence GGA.

**APP Wind DIR SPD** (Apparent Wind Direction) – Shows the Apparent Wind Direction when an external wind instrument with NMEA is connected.

**APP Wind SPD** (Apparent Wind Speed) – Shows the Apparent Wind Speed when an external wind instrument with NMEA is connected.

**BRG** (Bearing) – The direction from your current position to a Destination point.

**COG** (Course Over Ground) – The course your vessel is heading.

**DATE** – Shows the current date received by the GPS.

**DEPTH** – Shows the water depth when the optional FF525 50/200kHz BLACK BOX FISH FINDER or Digital Depth Sounder is connected.

**DEPTH AREAS** – Depth Areas are the sea areas included in the user selectable range of minimum and maximum depth limits. The sea area that is **beyond** the selected range is filled by a uniform white color, the sea area that is **inside** the selected range is filled by ordinary multicolor shading. The Spot Soundings and Depth Contours are displayed on the range only.

**DRAUGHT** – Depth of water the vessel draws. The definition of **draught** (or **draft**) of a ship's hull is the vertical distance between the waterline and the bottom of the hull (keel). Draught determines the minimum depth of water a ship or boat can safely navigate. On the Celestial page the "**draught**" window shows the height of the tidal water during a 24hr period of time. This height is dependant on the time of day selected using the ShuttlePoint knob.

**DSC** (Digital Selective Calling) – Digital Selective Calling is a semi-automated method of establishing a VHF Radio call. DSC had also been designated as part of the Global Maritime Distress and Safety System (GMDSS). It is planned that DSC will eventually replace aural watches on distress frequencies and will be used to announce routine and urgent maritime safety information broadcasts.

**DST** (Distance) – The distance from your current position to a Destination point.

**ETA** – Estimated Time of Arrival

**GPS Constellation** – The Global Positioning System (GPS) is a space-based radio-navigation system consisting of a constellation of satellites and a network of ground stations used for monitoring and control. A minimum of 24 GPS satellites orbit the Earth at an altitude of approximately 11,000 miles providing users with accurate information on position, velocity and time anywhere in the world and in all weather conditions.

**GPS2D** – The GPS is receiving at least 3 valid satellites.

**GPS3D** – The GPS is receiving at least 4 Satellites.

**HDG** (Heading) – Shows heading from an External Flux Gate Compass when connected.

**HDOP/VDOP** – Horizontal/Vertical Dilution of Precision. It is a parameter indicating the precision of the positioning system (GPS). The smaller the HDOP/VDOP value, the more accurately the position fix is provided.

**HEIGHT** – The current tide height referred to the vertical cursor.

**HIGH WATER** – The maximum level of the tide height in 24 hours.

**LOW WATER** – The minimum level of the tide height in 24 hours.

**PINGO** – It is a mound of earth-covered ice found in the Arctic and subarctic that can reach up to 70 metres (230Ft) in Height and up to 600 metres (2.000 Ft) in diameter.

**Position Request** – Marine DSC VHF Function of transmitting a GPS position to another Marine DSC VHF. When GPS Chart Plotter is connected to STANDARD HORIZON GPS the position of another vessel is shown on the Chart page.

**SPEED** – Shows the Speed Thru the Water when a Digital Speed Log is connected.

**SOG** (Speed Over Ground) – The speed you vessel is travelling at.

**STEER** – Heading to steer to destination Waypoint.

**TIME** – Shows the current time received by the GPS.

**TRIP LOG** – Shows the distance the vessel has travelled since the trip log was reset.

**TRU Wind DIR** (True Wind Direction) – Shows the True Wind Direction when an external wind instrument with NMEA is connected.

**TRU Wind SPD** (True Wind Speed) – Shows the True Wind Speed when an external wind instrument with NMEA is connected.

**TTG** (Time To Go) – Shows time to go to reach a Destination point.

## UNITS

**Nm** Nautical Mile (1 Nm = 1.15 Sm or 1.85Km)

**Sm** Statue Mile (1Sm = 0.87Nm or 1.61Km)

**Km** Kilometer (1 Kilometer = 0062 Sm or 0.54Nm)

**Ft** Feet (1 Foot = 0.167 Fathoms or 0.305 Meters)

**FA** Fathom (1 Fathom = 6 Feet or 1.83 Meters)

**Mt** Meter (1 Meter = 3.28 Feet or 0.55 Fathoms)

**Kts** Knot (1 Knot = 1.15 MPH or 1.85 KPH)

**MPH** Miles Per Hour (1 MPH = 0.87 Knots or 1.61 KPH)

**Kmh** Kilometer Per Hour (1 KPH = 0.54 Knots or 0.62 MPH)

**VMG** – It is the destination closing Velocity. The VMG is calculated using the current speed of the vessel (SOG) and the difference between the current vessel course and the bearing to the Destination.

**WAAS 2D/3D** – The GPS is receiving a 2D or 3D position and the correction from the WAAS Satellite. WAAS consists of approximately 25 ground reference stations positioned across the United States that monitor GPS satellite data. Two master stations, located on either coast, collect data from the reference stations and create a GPS correction message. This correction accounts for GPS satellite orbit and clock drift plus signal delays caused by the atmosphere and ionosphere. The corrected differential message is then broadcast through one of two geostationary satellites, or satellites with a fixed position over the equator. The information is compatible with the basic GPS signal structure, which means any WAAS-enabled GPS receiver can read the signal.

**WATER TEMP** – Shows the sea water temperature when the FF525 50/200kHz BLACK BOX FISH FINDER or a Digital Speed Log/Temp instrument with NMEA is connected.

**XTE** (Cross Track Error) – The distance your vessel is off course (left or right) to a Destination point.

---

# ANALYTICAL INDEX

---

<b>A</b>	
ABOUT PAGE .....	31
About page .....	102
Accessories .....	10
Activation Range .....	95
Active Target .....	95
ACTIVE TRACK .....	68, 69
Adjusting Time .....	25
advanced features .....	9
Advanced Setup .....	90
AIS .....	14, 97
AIS List .....	9, 98
AIS List page .....	9, 97, 98
AIS menu .....	96
AIS NMEA message .....	14
AIS Symbols .....	96
alarm conditions .....	65
Alarm Status List .....	105
Alarms .....	92
Alaska .....	9, 41, 73
alphanumeric input .....	21
alphanumeric key .....	21
ALT .....	76
Alter .....	91
Alternate Solution .....	91
Altitude .....	29, 76, 112
Anchor Alarm .....	92
antenna .....	9, 12
APA .....	90, 109
APB .....	90, 109
Apparent Wind Direction .....	76, 112
Apparent Wind Speed .....	76, 112
ASF1/2 .....	91
assistance .....	9
Attention Areas .....	78, 79
Audible Alarm .....	92
AUTO INFO .....	30, 77, 94
Auto Position .....	94
Auto Switch .....	18
Automatic Route Check .....	66
autopilot .....	14, 15
AWD .....	76
AWS .....	76
<b>B</b>	
back up .....	70
background .....	9, 19
Backlight .....	20, 24, 108
Bahamas .....	9, 41, 73
Bathymetric .....	42
BATTERY CONNECTIONS .....	13, 14, 16
Bearing .....	22, 76, 112
Bearings .....	92
beep .....	19
BOD .....	90, 109
bracket mounting .....	11
BRG .....	22, 76, 112
BUILT-IN CHARTS .....	31, 41
Built-In Charts .....	9
Built-in Coastal maps .....	9
BWC .....	86, 90, 109
<b>C</b>	
C-CARD .....	41, 42, 43
C-CARD Connector .....	108
C-CARD Test .....	108
C-MAP .....	42
C-Weather .....	99
Calibration .....	92
Canada .....	9, 41, 73
Caribbean .....	9, 41, 73
Cartographic Data .....	43
Cartography .....	9, 109
Cartridges .....	108
Category .....	38
CAUTION .....	4
Caution page .....	21
Caution pages .....	21
CELESTIAL .....	29
Celestial page .....	18, 83, 84
Central America .....	9, 41, 73
Chain .....	26
Change Focus .....	74
change the fields .....	19
Changing date .....	83
Changing the User C-CARD .....	71
CHART .....	44
Chart Boundaries .....	78, 80
CHART CONFIGURATIONS .....	82
Chart Datum .....	91
chart details .....	19
Chart Lock .....	78, 81
CHART PAGE .....	30
Chart page .....	22
Chart Scale .....	19, 76
Chart selection menu .....	73
Chart Settings .....	80, 82
CHART/COMPASS .....	29
CHART/HIGHWAY .....	29
Chinese .....	27
Classic .....	27, 30
Clear Info .....	43
Clear View .....	43
CLR .....	18, 19, 23
COG .....	67, 73, 76, 112
Color (Route) .....	65
Color AIS Targets .....	98
color of Track .....	68
Color Targets AIS .....	9
COMPASS HEADING .....	31
Compass menu .....	92
COMPASS ROSE .....	31
Compass Rose .....	9, 82
Compass Table .....	92
Compass Tape .....	83
Connections .....	13, 101
Contrast .....	20
contrast .....	24, 107
convention .....	19
Coordinate System .....	26, 91
Coordinates .....	39
Copy From Memory Card .....	100
Course Over Ground .....	67, 76, 112
COURSE UP .....	29
Course Up .....	24
cover .....	10
CPA .....	95, 96
CPA Alarm .....	95, 96



CPA Limit .....	95, 96	Draught .....	112
Creating a Route .....	60	draught .....	84
crew monitoring system .....	101	Dredged Areas .....	65
cross hair .....	22	DSC .....	9, 18, 86, 88, 94, 109, 112
Cross Track Error .....	76, 113	DSC DIRECTORY .....	29
Cuba .....	9, 41, 73	DSC Distress Call .....	89
Currents Prediction .....	49	DSC LOG .....	29
cursor .....	19, 22, 23	DSC Log .....	89
Cursor Control .....	93	DSC POLLING .....	94
Cursor Mode .....	19, 22	DSE .....	86, 109
CURSORSPEED .....	30	DSI .....	81
Cursor Speed .....	23	DSI - Data Safety Indicator .....	47
CURSOR WINDOW .....	30	DST .....	22, 76, 112
Customizing Data Windows .....	75	DTP .....	76
CUSTOMIZING SOFT KEYS .....	29	Dual .....	73
<b>D</b>		DUAL CHART .....	29
dangerous objects .....	65	Dual chart window .....	9
dangerous Route leg .....	65	Dutch .....	27
Dangerous Target .....	95	DVD .....	9
Danish .....	27	Dynamic Currents .....	43
Data Features .....	42	Dynamic Nav-Aids .....	43, 47
Data Safety Indicator .....	81	<b>E</b>	
Data Window .....	75	EDIT .....	65
Data window layout .....	75	Edit Route .....	61
DATE .....	112	EGNOS .....	85
Date .....	76, 83	Enhanced Mixing Levels .....	43
DATE FORMAT .....	29	Enhanced Port Info .....	43, 52
DBT .....	86, 91, 109	ENT .....	19
delete a Route .....	64	Estimated Time of Arrival .....	76
Delete PTX .....	104	ETA .....	76, 112
Delete Track .....	68	External bracket .....	10
Deleting a file .....	71	External device .....	86
DELETING A MOB .....	59	Extra Large Coverage .....	42
Deleting a Track .....	68	<b>F</b>	
Deleting Mark .....	54	FA Fathom .....	113
Deleting MOB .....	59	FF MODULE .....	110
Deleting Waypoint .....	54	FF520 .....	14
Demo Mode .....	93	FF525 .....	9, 14, 29, 87, 112, 113
DEPTH .....	112	FIND .....	29
Depth .....	29, 76	Find .....	43
Depth Alarm .....	92	FIND SERVICES .....	32
Depth Area .....	112	Finnish .....	27
Depth contours .....	41	FISH FINDER .....	9, 29, 90
Depth limit .....	66	FISH FINDER 200kHz .....	29
Depth Range Max .....	78, 79	FISH FINDER 200kHz/CHART .....	29
Depth Range Min .....	78, 79	FISH FINDER 50/200kHz .....	29
Depth Settings .....	79, 82	FISH FINDER 50kHz .....	29
Depth Sounder .....	85	FISH FINDER 50kHz/CHART .....	29
DEPTH TREND .....	29	Fishing Facility .....	65
Depths .....	42	fix .....	106
destination .....	20	Fix coordinates .....	26
Diagrams .....	50	Fix Status .....	76
Differential Correction Source .....	85	Flexi-Zoom .....	43, 44
Diffusers .....	65, 78, 81	Flush Mount cutout .....	110
Digital Depth Sounder .....	87	Flush mounting .....	10, 11, 12
Digital Selective Calling .....	88	Flux gate compass .....	85
DIM Menu .....	107	forecast .....	100
Dimensions .....	109, 111	Formatting User C-CARD .....	70
Display .....	109	French .....	27
DISPLAY COLOR .....	30	FT Feet .....	113
Display Color .....	27, 85	Full Screen View .....	17
Display Mode .....	77	<b>G</b>	
Display Resolution .....	109	German .....	27
Distance .....	22, 29, 76, 112	Getting Started .....	21
Distance & Time Units (track) .....	67	GGA .....	86, 91, 109, 111, 112
Distress Call .....	89	GLL .....	86, 90, 109
Distress call .....	89	GMDSS .....	112
Download Area .....	100	GOTO .....	20, 63, 73
download weather data .....	99	GOTO CURSOR .....	57
DPT .....	86, 91, 109	GOTO MARK .....	58

Goto PTX .....	104	LANGUAGE .....	30
GOTO ROUTE .....	58	Language .....	27, 50
GPS .....	9, 12, 13, 21, 84, 111, 112	Language Selection .....	28
GPS antenna connections .....	13	Lat/Lon Grid .....	78, 80
GPS Cable .....	13	Latitude .....	26
GPS Constellation .....	112	LCD .....	9, 24, 109
GPS information .....	85	legend .....	11, 19
GPS Performance .....	111	Loading a file .....	71
GPS Receiver .....	111	locate Points Of Interest .....	38
GPS Receiver Sensitivity .....	111	locate Port .....	33
GPS Setup Menu .....	85	locate Tide Stations .....	33
GPS Status .....	29	locate Wrecks .....	34
GPS Status page .....	18, 21, 84	Longitude .....	26, 80
GPS2D .....	112	Loran .....	26
GPS3D .....	112	Loran TD .....	91
Great Lakes .....	9, 41, 73	Lost Target .....	95
Greek .....	27	LOW WATER .....	113
Grounding Alarm .....	92	Low Water .....	84
GSA .....	86, 109, 111	<b>M</b>	
GSP Status .....	76	Main Menu .....	19, 72
GSU-5H .....	10	MAN OVER BOARD .....	59
GSV .....	86, 109, 111	Marine Settings .....	78, 82
Guardian Alarm .....	43	MARK .....	20, 53
<b>H</b>		Mark .....	9, 20, 38, 53, 54, 60, 70, 109
Hawaii .....	9, 41, 73	Mark creation .....	53
HDG .....	76, 86, 90, 109, 112	MARKS/WAYPOINTS .....	29
HDM .....	86, 109	Marks/Waypoints List .....	56
HDOP .....	76, 85, 112	Max Functions Menu .....	44
HDT .....	86, 109	Max Speed .....	76
Heading .....	76	MEASURE DISTANCE .....	30
HEIGHT .....	112	MENU .....	19
HIGH WATER .....	112	Mixing Levels .....	78, 81
High Water .....	84	MMSI .....	95, 96
HIGHWAY .....	29	MMSI number .....	95
Highway page .....	18, 83	MOB .....	20, 103
Home Mode .....	19, 22	MOBILARM .....	101
Horizontal Dilution of Precision .....	76	Mooring .....	65
HSC .....	91, 109	mounting .....	11
<b>I</b>		Moving a Waypoint .....	54
ICON .....	30, 55	Moving Mark .....	54
Icon Size .....	45	MPH Miles Per Hour .....	113
INFO .....	20	Mt Meter .....	113
information .....	39, 77	MTW .....	86, 91, 109
Input .....	90	Multilanguage Support .....	43
INPUT/OUTPUT .....	90	MWD .....	109
INSERTING A WAYPOINT .....	63	MWV .....	109
Inserting C-CARD .....	41, 42	<b>N</b>	
installation .....	11	Name .....	95
Interface .....	109	Name Tags .....	78, 79
Intertidal Areas .....	65	name the Route .....	61
ISO Certification .....	42	NAME TO A ROUTE .....	61
Italian .....	27	Nav Aids & Light Sectors .....	78
<b>J</b>		NAV AIDS PRESENTATION .....	30
Japanese .....	27	Nav-Aids .....	47
<b>K</b>		nav-aids .....	41
key .....	19, 21	Nav-Aids & Light Sectors .....	79
Keyboard .....	109	Navigate menu .....	91
KEYPAD BEEP .....	29	Navigating a Route .....	93
Km Kilometer .....	113	NAVIGATION .....	29
Kmh Kilometer Per Hour .....	113	Navigation .....	18, 82
Kts Knot .....	113	NAVIGATION PAGE .....	30
<b>L</b>		Navigation page .....	82, 83
labelled key .....	19	Navigation Speed .....	85
Lake .....	35	Night .....	27, 30
Lakes By Name .....	37	night vision .....	27
Lakes Information .....	35	Nm Nautical Mile .....	113
Land Areas .....	65	NMEA .....	14, 16, 56, 85, 86, 90, 111
Land Elevation .....	42, 78, 79	NMEA CONNECTIONS .....	14
Land Elevation Values .....	78, 80	NMEA DATA .....	29
Land Settings .....	79, 82	NMEA Data .....	86

NMEA Data page .....	87
NMEA Display .....	18, 29, 85, 86
NMEA Display menu .....	86, 87, 88
NMEA Input .....	90, 109
NMEA Output .....	90, 109
NMEA RTE .....	65
NMEA-0183 .....	109
NOAA .....	27, 30
non-Latin characters .....	27
Normal .....	27, 30
NORTH UP .....	29
North Up .....	24
Norwegian .....	27
NTSC .....	9, 17
numeric input .....	21
<b>O</b>	
Object Info .....	43
Obstructions .....	35, 65, 78, 81
Off-line redraw .....	43
Official data source .....	42
Olympic Route .....	9
OPTIONAL ACCESSORIES .....	10
Ouput .....	90
Outdoor Recreational Area .....	35
Over-Zoom .....	45
<b>P</b>	
PACKING LIST .....	10
PAL .....	9, 17
panel controls .....	19
PC-Planner .....	99
PCMPA .....	109
PCMPD .....	109
Perspective View .....	43, 46
Photos & Diagrams .....	43
Picture in Picture .....	18
Pingos .....	65, 113
PIP .....	18
PJRC D .....	109
PJRC F .....	109
PKODG .....	109
Place Name Size .....	45
Place Names .....	78
Place Names size .....	45
PLACING A MOB .....	59
Points Of Interest .....	38, 78, 80
Port .....	33
Port Info .....	43, 52, 53
Port Plan .....	43
Port Services .....	32
Ports & Services .....	78, 79
Portuguese .....	27
POSITION Request .....	88
Position Request .....	89, 94, 113
Position Request Call .....	89
POSITION Send .....	88
Position Send Call .....	89
power boat .....	9
Power Consumption .....	109
Power On, Off .....	21
Power supply .....	109
Presentation Features .....	43
Production Installation .....	65
PTX .....	102
PTX information window .....	104
PTX List page .....	105
Puerto Rico .....	9, 41, 73
PWR .....	20, 24
PWR & ACC 1 Cable .....	13
PWR Cable .....	13

<b>Q</b>	
Quick Activation .....	18
Quick Info .....	43
Quick Reference Guide .....	10
<b>R</b>	
RADAR .....	9
Radar .....	9, 10
Radar Installation .....	16
Radio Call Sign .....	95
RAM Clear .....	107
RAM Menu .....	107
Real Time View .....	100
RECEIVE .....	65
replacement parts .....	10
Restart GPS .....	85
RESTORE DEFAULTS .....	18
Reverse Route .....	65
RMA .....	90, 109
RMB .....	91, 109
RMC .....	86, 91, 109, 111
Roads .....	43, 78, 80
Rocks .....	65, 78, 81
ROUTE .....	20
Route .....	9, 20, 53, 60, 70, 93, 109
Route Check .....	9
ROUTE CHECK REPORT .....	66
Route Checking .....	65
Route Report .....	61, 62, 63, 64, 65, 66
Route Width .....	66
RTE .....	15, 56, 65, 86, 109
Russian .....	27
<b>S</b>	
Safety Route Check .....	43
Safety Status Bar .....	47
sailboat .....	9
satellite .....	9, 84
Satellite Imagery .....	48
Saving Track .....	68
Scale .....	76
screen .....	4, 106
Screen display pages .....	28, 72
Seabed Type .....	78, 79
Search .....	43
Select Route .....	65
select the language .....	27
SEND .....	65
Serial Ports .....	108
Setup / Reset .....	69
Setup Menu .....	19, 85
Shallow Water .....	65
SHIP ICON .....	30
Ship icons .....	9, 23
Shoreline Constructions .....	65
ShuttlePoint knob .....	19
SI-TEX .....	10
SIM Pin .....	99
Simulation .....	93
Simulation Mode .....	93
Single .....	73
Sleeping Target .....	95, 96
Sm Statue Mile .....	113
Smart GPS Cable .....	13
Soft Key .....	18, 20
Software .....	31
SOG .....	9, 73, 76, 113
SOG TREND .....	29
SORT .....	55
Spanish .....	27
SPD .....	76
SPECIFICATIONS .....	109

Speed .....	29, 67, 76, 113
Speed Filter .....	9, 85
Speed Log .....	85, 87
Speed Over Ground .....	76
Spot Soundings .....	42
spot soundings .....	41
Standard (Zoom Type) .....	44
Standard Zoom .....	44
start a new Track .....	68
start navigating .....	20
Start-Up page .....	21
Static Navigation .....	91
STEER .....	113
Steering .....	76
stop navigation .....	20, 58
STR .....	76
Sunlight .....	27
Swedish .....	27
SWITCHING TIMEOUT .....	18
System Test .....	107
<b>T</b>	
Target .....	95
TCPA .....	95, 96
TCPA Alarm .....	95, 96
TCPA Limit .....	95, 96
TD .....	26, 91
technical support .....	9
Temp .....	76
TEMP TREND .....	29
Temperature .....	29, 109
TERMS .....	112
THICKNESS .....	65
Tidal .....	41
Tidal stream arrows .....	49
Tide .....	49, 79, 83
Tide draught .....	34
Tide Graph .....	84
Tide height .....	34, 84
Tide Stations .....	33
Tides & Currents .....	78, 79
Tides Preview .....	43
TIME .....	113
Time .....	67
time .....	76
Time Format .....	29
TIME SETUP .....	29
Time Setup menu .....	25
Time To Go .....	76, 113
TLL .....	86, 109
TLOG .....	76
Track .....	9, 73
track .....	67, 70
Track Points .....	67, 109
Tracking .....	68, 69
Tracks & Routes .....	78, 79
TRIP LOG .....	69
Trip Log .....	69, 76, 113
Trip Log selection .....	69
TROUBleshooting .....	106
True Wind Direction .....	76, 113
True Wind Speed .....	76, 113
True-Type Font .....	43
TTG .....	76, 113
turn Chart Plotter On/Off .....	20
turn the GPS Chart Plotter On .....	42
TWD .....	76
TWS .....	76
TXT .....	111
Type .....	38
Type of Data .....	100

<b>U</b>	
Under-Zoom .....	45
Underwater Ob. Limit .....	78
Underwater Object Limit .....	81
Underwater Objects Settings .....	81
Underwater Settings .....	82
UNITS .....	113
UNITS OF MEASURE .....	29
Updating Built-In Charts .....	41
US English .....	27
USA .....	9
User C-CARD .....	29, 70, 99
User C-CARD Menu .....	70
User Points .....	38, 109
Using the Trip Log .....	69
UTC .....	25
UTM .....	26, 91
<b>V</b>	
Value Added Data .....	78, 81
Variation .....	92
VDM .....	109
VDOP .....	76, 85, 112
Velocity Made Good .....	76
Vertical Dilution of Precision .....	76
vessel position .....	73
VGA .....	9, 17
VGA output .....	17
VGA Video Output .....	17
VHF Connections .....	16
VHF radio .....	88
VHW .....	86, 91, 109
Video camera .....	9
Video Input .....	17, 29
video output .....	9
VMG .....	76, 113
VTG .....	86, 90, 109
VWR .....	86, 109
VWT .....	86, 109
<b>W</b>	
WAAS .....	12, 76, 84, 111, 113
WAAS 2D/3D .....	113
Warning .....	58
Warping Facility .....	65
warranty .....	9
WATER TEMP .....	113
Water Temperature .....	67, 76
Waypoint .....	20, 53, 54, 60, 109
WCV .....	90, 109
Weather data package .....	99
Weight .....	109, 111
WGS84 .....	91, 111
Wind speed .....	85
WIND SPEED TREND .....	29
Wind Speed/Direction .....	87
Window Selections .....	75
WINDOWS SETUP .....	30
World Background .....	42
Worldwide background .....	19
WPL .....	15, 56, 86, 109
Wrecks .....	34, 41, 65, 78, 81
<b>X</b>	
XTE .....	76, 90, 92, 109, 113
XTE Alarm .....	90, 92
<b>Z</b>	
zoom .....	45
zoom factor .....	45
ZOOM IN .....	19, 44
ZOOM OUT .....	19, 44
Zoom Type .....	44

## PLEASE NOTE

**The following "Limited Warranty" is for customers that have purchased products in the United States. For Limited Warranty details outside the United States, contact the dealer in your country.**

### STANDARD HORIZON LIMITED WARRANTY

STANDARD HORIZON (a division of Vertex Standard USA) warrants, to the original purchaser only, each new Marine Product ("Product") manufactured and/or supplied by STANDARD HORIZON against defects in materials and workmanship under normal use and service for a period of 3 years from the date of purchase.

In the event of a defect, malfunction or failure of the Product during the warranty period, Standard Horizon's liability for any breach of contract or any breach of express or implied warranties in connection with the sale of Products shall be limited solely to repair or replacement, at its option, of the Product or part(s) therein which, upon examination by STANDARD HORIZON, appear to be defective or not up to factory specifications. STANDARD HORIZON may, at its option, repair or replace parts or subassemblies with or reconditioned parts and subassemblies.

To receive warranty service, the purchaser must deliver the Product, transportation and Insurance prepaid, to STANDARD HORIZON (Marine Division of Vertex Standard) - Attention Factory Service - 6125 Phyllis Drive - Cypress, CA 90630, include proof of purchase indicating model, serial number and date of purchase.

STANDARD HORIZON will not warrant installation, maintenance or service of the Products. In all instances, STANDARD HORIZON's liability for damages shall not exceed the purchase price of the defective Product. This warranty only extends to Products sold within the 50 States of the United States of America and the District of Columbia.

STANDARD HORIZON will pay all labor and replacement parts charges incurred in providing the warranty repair service except where purchaser abuse or other qualifying exceptions exist. The purchaser must pay any transportation expenses incurred in returning the Product to STANDARD HORIZON for service.

This limited warranty does not extend to any Product which has been subjected to misuse, neglect, accident, incorrect wiring by anyone other than STANDARD HORIZON, improper installation, or subjected to use in violation of instructions furnished by STANDARD HORIZON, nor does this warranty extend to Products on which the serial number has been removed, defaced, or changed. STANDARD HORIZON cannot be responsible in any way for ancillary equipment not furnished by STANDARD HORIZON which is attached to or used in connection with Products, or for the operation of the Product with any ancillary equipment, and all such equipment is expressly excluded from this warranty. STANDARD HORIZON disclaims liability for range, coverage, or operation of the Product and ancillary equipment as a whole under this warranty.

STANDARD HORIZON reserves the right to make changes or improvements in Products, during subsequent production, without incurring the obligation to install such changes or improvements on previously manufactured Products. The implied warranties which the law imposes on the sale of this Product are expressly LIMITED, in duration, to the time period specified above. STANDARD HORIZON shall not be liable under any circumstances for consequential damages resulting from the use and operation of this Product, or from the breach of this LIMITED WARRANTY, any implied warranties, or any contract with STANDARD HORIZON. IN CONNECTION WITH THE SALE OF ITS PRODUCTS, STANDARD HORIZON MAKES NO WARRANTIES, EXPRESS OR IMPLIED AS TO THE MERCHANTABILITY OR FITNESS FOR A PARTICULAR PURPOSE OR OTHERWISE, EXCEPT AS EXPRESSLY SET FORTH HEREIN.

Some states do not allow the exclusion or limitation of incidental or consequential damages, or limitation on how an implied warranty lasts, so the above limitation or exclusions may not apply. This warranty gives specific legal right, and there may be other right which may vary from state to state.