

 STANDARD HORIZON

CPN700i/CPN1010i

Multimedia Chart Plotters

Owner's Manual



Only for USA users



CPN700i



CPN1010i



WARNING!

Electronic charts displayed by the CPN Series Chart Plotter are believed to be accurate and reliable, but are not intended to be a substitute for the official charts, which should remain your main reference for all matters related to the execution of safe navigation. For this reason you should always keep the official published and approved nautical charts on board.



FCC Compliance Statement

This device complies with Part 15 of the FCC limits for Class A digital devices. This equipment generates, uses and can radiate radio frequency energy and, if not installed or used in accordance with the instructions may cause harmful interference with radio communications.

There is no guarantee that interference will not occur in a particular instance. If this equipment does cause harmful interference to other equipment, try to correct the problem by relocating the equipment.

Consult an authorized STANDARD HORIZON dealer or other qualified service technician if the problem cannot be corrected. Operation is subject to the following conditions: (1) This device cannot cause harmful interference, and (2) this device must accept any interference received, including interference that may cause undesired operation.



CAUTION

- The CPN Series Chart Plotter is designed for maritime use. To avoid water intrusion, ensure the C-MAP BY JEPPESEN SD CARD door is completely closed.*
- Extensive exposure to heat may result in damage to the CPN Series Chart Plotter.*
- The CPN Series Chart Plotter contains dangerous high-voltage circuits which only experienced technicians can handle.*
- STANDARD HORIZON will not be liable for errors contained herein, or for incidental or consequential damages in connection with the performance or use of this material.*

The **Bluetooth®** word mark and logos are owned by the Bluetooth SIG Inc., **Wi-Fi®** is a registered trademark of the Wi-Fi Alliance and any use of such name by Standard Horizon Marine Division of Vertex Standard is under license. Windows®, Windows CE®, Microsoft Internet Explorer® and Microsoft Multimedia Player® are registered trademarks of Microsoft Corporation in the United States and/ or other countries. MicroSD™ is a trademark of SanDisk or its subsidiaries.

TABLE OF CONTENTS

INTRODUCTION	10
PACKING LIST	11
OPTIONAL ACCESSORIES	12
GENERAL OPERATION	13
MANUAL CONVENTIONS	13
POWER UP SEQUENCE	13
POWERING OFF	13
BRIGHTNESS CONTROL	14
CHART PLOTTER FRONT PANEL	14
TOUCHSCREEN	15
Touchscreen Keys	16
Touchscreen Keyboard	16
Touchscreen Keyboard for Chart Plotter Mode	16
Touchscreen Keyboard for other applications	17
MENU DESCRIPTION	17
Warning Window	18
Information Window	18
SELECTING A ITEM	18
CHART PLOTTER CONTROLS	19
KEYS	19
PLAYING MUSIC IN BACKGROUND (for Chart Plotter Mode only)	21
Starting to play in background	21
Stopping to play	22
SOFT KEYS (for Chart Plotter Mode only)	22
Closing Soft Keys	23
MEMORY DEVICES SAFELY REMOVAL	23
CHART PLOTTER	24
GETTING STARTED	24
SWITCHING BETWEEN MODES	25
Default Mode	25
Home vs Cursor Mode	25
Cursor Mode	25
Switching between 2D and 3D modes	26
MENU SYSTEM	27
INITIAL SETUP	28
Cursor and Menu selection speed	28
Changing the Ship Icon	28
Selecting Course Up/North Up	29
Pages Selection	29
Assigning Page Soft Keys	31
Time Setup	31
Selecting Coordinate System	33
Loran TD	33
Changing the Display Color	33
Selecting Language	34
Chart Control Icon	35
SETTINGS IN GENERAL SETUP MENU	36
CARTOGRAPHY OVERVIEW	37
BUILT-IN CHARTS --- AVAILABLE ONLY FOR USA	37
Updating Built-In Charts	38
C-MAP 4D	40

C-MAP 4D: MAX Content	41
C-MAP 4D: FULL 4D Content	41
C-MAP 4D: Value Added Data	42
VALUE ADDED DATA MENU	42
REMOVING A SD CARD	42
USING FIND SERVICES	43
PORT SERVICES	43
PORT	44
TIDE STATIONS	45
Changing the day	45
Changing Tide Station	45
WRECKS	46
OBSTRUCTIONS	46
LAKES INFORMATIONS	47
QUICK AND FULL INFO ON LAKES	48
LAKES BY NAME	48
POINTS OF INTEREST	49
USER POINTS	49
COORDINATES	50
INFORMATIONS	50
CHART DISPLAY FUNCTIONS	51
4D FUNCTIONS	51
Chart Window	51
Display Mode	51
Overlay	52
Overlay Mode	52
Transparency	53
3D Exaggeration Factor	53
GENERAL CHART DISPLAY FUNCTIONS	53
Icon Size	53
Place Name Size	54
Safety Status Bar (DSI - Data Safety Indicator)	54
Currents Prediction	55
Chart Language	56
Course Up/North Up	56
Nav-Aids Presentation	57
Ship Icon	57
Course Time Line	57
Compass Indicator	58
Ship Icon Position	58
PICTURES & DIAGRAMS	58
How to show the Pictures or Diagrams of a Object	59
CREATING MARKS	60
CREATING A NEW MARK USING THE CHART PAGE	60
EDITING A MARK OR WAYPOINT	60
DELETING A MARK OR WAYPOINT	61
MOVING A MARK OR WAYPOINT	61
MARKS/WAYPOINTS (USER POINTS) LIST	62
CREATING/MODIFY A NEW MARK IN THE USER POINTS LIST	63
ROUTES	64
CREATING A ROUTE USING WAYPOINTS	65
CHANGING THE NAME OF A ROUTE	65
CREATING AN OLYMPIC ROUTE OR BOUNDARY	66
MAKING ADDITIONAL ROUTES	66
CREATING A ROUTE USING MARKS ON THE CHART PAGE	67
INSERTING A WAYPOINT INTO A ROUTE	67

DELETING A ROUTE	68
OTHER SETTINGS IN ROUTE MENU	68
ROUTE CHECK	68
EASY ROUTING (ER)	70
Warning Messages	72
GOTO KEY OPERATION	73
GOTO CURSOR	73
GOTO A ROUTE	74
Using GOTO to select Route	74
Using the ShuttlePoint Knob	75
GOTO MARK	75
MAN OVER BOARD (MOB) FUNCTION	76
PLACING A MOB POINT	76
DELETING A MOB POINT	76
TRACKS	77
SAVING AND STARTING A NEW TRACK	78
DELETING A TRACK	78
OTHER SETTINGS IN THE TRACK MENU	78
TRIP LOG	78
TRIP LOG SELECTION IN DATA WINDOW	78
SETUP / RESET	79
USER SD CARD	79
FORMATTING THE SD CARD	80
TRANSFERRING FILES TO THE SD CARD	80
LOADING A FILE FROM THE SD CARD	81
DELETING A FILE FROM THE SD CARD	81
REFRESHING THE SD CARD	81
MAIN MENU	82
SELECTING A PAGE OR MENU	82
CUSTOMIZING A PAGE ICON	83
CHART PAGE	83
Single	84
Dual	84
Data Window Selections	84
Customizing Data Windows	85
Collapsing Data Windows	86
Additional Functions on Chart Page: Information on Objects	87
Display Mode	88
Marine Settings	89
Depth Settings	89
Chart Settings	90
Underwater Objects Settings	91
NAVIGATION PAGES	91
Highway Page	91
Chart/Highway Page	92
Compass Page	92
GPS Status Page	93
Setup Menu	93
WAAS/EGNOS Setting	94
NMEA DATA PAGES	94
NMEA Display Page	94
Customizing data box in the NMEA Display Page	95
NMEA Data Page	95
FISH FINDER (optional FF525 required)	96
TIDE PAGE	96
Tides	96

VHF DIGITAL SELECTIVE CALLING	97
NMEA 0183 Interfacing	98
Distress Call	98
Position Request	98
DSC Directory	99
VIDEO INPUT	99
Video Input menu	99
Video adjustment mode	100
Restore Defaults	100
ADVANCED SETTINGS	101
NAVIGATE MENU	101
Loran TD	101
COMPASS (COG) SETUP	102
INPUT/OUTPUT (NMEA) CONNECTIONS	102
Input/Output	102
NMEA 0183 output sentences	103
ALARMS	103
SIMULATION	104
Navigating a Route in Simulation mode	104
DSC POLLING	105
ABOUT PAGE	105
DAM Report Page	106
AIS	107
SYSTEM DEFINITIONS	107
MENU	108
QUICK INFO ON AIS TARGET	108
LIST	109
AIS TARGET COLORS	109
CONNECTION MANAGER	111
GETTING STARTED	111
STARTING THE CONNECTION MANAGER	111
CONNECTION MANAGER OVERVIEW	112
Wi-Fi® CONNECTION	112
CONNECTION MANAGER CONTROLS	113
HOW TO CONNECT	113
AUTHENTICATION/ENCRYPTION PROTOCOLS	114
NETWORKING CONNECTION: C-MAP 4D CHARTS,NMEA & FISH FINDER DATA SHARING	115
CPN SERIES CHART PLOTTER SETUP	115
Chart Plotter 1 Setup (with C-MAP 4D CARD inserted)	116
Chart Plotter 2 Setup (no chart inserted)	118
Custom Setup	120
INTERNET BROWSER	121
GETTING STARTED	121
STARTING THE INTERNET BROWSER	121
BROWSER OVERVIEW	122
INTERNET BROWSER CONTROLS	123
HOW TO NAVIGATE	124
THE SIGNAL INDICATOR ICON	125
THE FAVORITE PAGES AND HISTORY LIST	125
FAVORITES	125
THE DOWNLOAD MANAGER	126
MEDIA PLAYER	129
GETTING STARTED	129
STARTING MEDIA PLAYER	129
MEDIA PLAYER CONTROLS	130
SAVING FILES ON A USB THUMB DRIVE	132

VIEWING AND PLAYING FILES	132
INSTALLATION	134
MOUNTING THE CPN SERIES CHART PLOTTER	134
BRACKET MOUNTING	134
FLUSH MOUNTING THE CPN SERIES CHART PLOTTER	135
MOUNTING THE OPTIONAL EXTERNAL GPS ANTENNA	137
FLUSH MOUNTING THE ANTENNA	137
CONNECTIONS	138
OVERVIEW	138
BATTERY CONNECTIONS	139
NMEA 0183 CONNECTIONS	140
PWR/ACC1 Connections	141
ACC 2 Connections	141
PORT Input selections	141
PORT Output sentences	142
CPN Series Chart Plotter to NMEA 0183 connection examples	142
VIDEO INPUT CONNECTOR	144
VIDEO INPUT CONNECTIONS for CPN700i	144
VIDEO INPUT/OUTPUT CONNECTIONS for CPN1010i	145
PRE-AMP OUTPUT - EXTERNAL AMPLIFIER/SPEAKER CONNECTIONS	145
CPN Pre-Amp connector pin out	146
OPTIONAL USB THUMB DRIVE	146
OPTIONAL EXTERNAL ALARM CONNECTION	147
OPTIONAL GPS ANTENNA	147
OPTIONAL FF525 BLACK BOX FISH FINDER	147
SECOND CPN TO SHARE C-MAP 4D CHARTS, NMEA & FF DATA	148
NMEA 2000 DEVICES and ETHERNET RADAR (for future release)	148
SPECIFICATIONS	149
CPN700i	149
DIMENSIONS	150
CPN1010i	150
DIMENSIONS	151
OPTIONAL FF525 FISH FINDER	152
OPTIONAL WAAS GPS RECEIVER	153
GPS CONNECTION IMAGE	154
TECHNICAL TESTS	155
SYSTEM TEST	155
RAM MENU (RESET)	155
RAM Clear	155
BACKLIGHT	156
CARTRIDGES (used by Standard Horizon Technicians)	156
Internal Data Base Test	156
SD CARD Test	156
SERIAL PORTS (used by Standard Horizon Technicians)	156
Change Parameters	156
Input Data Display	156
Loop-Back Test	156
SYSTEM UPDATE	157
SYSTEM UPDATE PROCEDURE	157
SYSTEM UPDATE ERROR MESSAGES	158
ERROR MESSAGES 01, 02, 03, 04, 05, 06, 07, 09	158
ERROR MESSAGE 08	159
ERROR MESSAGES 20, 21, 22	159
TERMS	161
ANALYTICAL INDEX	164

INTRODUCTION

Congratulations on your purchase of the STANDARD HORIZON CPN Series Chart Plotter. Whether this is your first Navigation device, or if you have other STANDARD HORIZON equipment, STANDARD HORIZON organization is committed to ensuring your enjoyment of this Navigation device. STANDARD HORIZON technical support personnel stand behind every product we sell. Our Product Support team invites you to contact us should you require technical advice or assistance, for USA users at 800/767-2450 or marinetech@vxstdusa.com, for European users at +44 1962 866667 or e-mail at marinetech@yaesu.co.uk.



Information in this Owner's Manual is subject to change without notice.

The CPN700i and CPN1010i are precision-crafted high-performance receivers for the Global Positioning System (WAAS GPS) constellation of satellites. The internal or optional GPS antenna provides precise location data with a host of navigation features ideal for nautical use. The CPN700i and CPN1010i are housed in rugged, impact-resistant cases with outstanding ergonomic design for effortless operation. The CPN700i and CPN1010i are IP57 waterproof.

The advanced features of the CPN Series Chart Plotter include:

- Built-In Charts² for coastal navigation of USA including Alaska, Hawaii and Great Lakes, Canada, Bahamas, Caribbean, Cuba, Mexico, Puerto Rico, and Central America. Fresh water coverage is not included. Detailed coverage and Fresh waters charts are available from Jeppesen.
- Optional C-MAP 4D cartography:
 - 3D View
 - Satellite Images
 - Raster Charts
 - Easy Routing
 - Value Added Data
- Display:
 - Sunlight viewable
 - Bonded with bright LED (1000 nits) backlight
 - CPN700i: 7" Wide VGA 800x480
 - CPN1010i: 10" Wide SVGA 1024x600
- Optional 50 channel WAAS GPS antenna with 30 Feet of cable
- Network interfaces:
 - Built-In **Wi-Fi**[®] and **Bluetooth**[®]¹ capability
 - Built-In **Internet Explorer**[®] 6.0 and **Windows Multimedia Player**[®]
 - USB 2.0 Connection compatible keyboard¹ or memory stick
 - NMEA 2000¹
- Front panel stereo and pre-amp outputs for optional audio amp
- Video Input:
 - CPN700i: 1 NTSC or PAL
 - CPN1010i: 2 NTSC or PAL

- AIS, FF525 Fish Finder and Si-Tex/Koden Radar¹ compatible capable
- Dual chart windows with independent zoom levels
- Selectable Sail boat and Power boat Ship Icons
- Compass Rose indication around Ship Icon
- Route checking
- Guardian Alarm
- Color Targets AIS
- Dedicated AIS List page
- Navigate to an Olympic Route
- Displays DSC Distress and Position Report calls received from a DSC VHF radio
- 3-years waterproof warranty

 ¹ Available in future software versions.

 ² Only for USA.













PACKING LIST

When the package containing the Navigation device is first opened, please check for the following contents. If any parts are missing, contact the dealer this Navigation device was purchased from.

Accessories and replacement parts may be ordered from STANDARD HORIZON's Parts Department for USA users at 714/827-7600 extension 6800 or e-mail at yaesuparts@vxstdusa.com, for European users at +44 1962 866667 or e-mail at marinetech@yaesu.co.uk.

PART CODE	ITEM
S8003046	External bracket (CPN700i)
S8003043	External bracket (CPN1010i)
S8003048	Bracket knob
S8003045	Dust cover (CPN700i)
S8003042	Dust cover (CPN1010i)
T9101553	PWR ACC1 & ACC2 cable
S8003044	Flush Mount Bracket
XUCMP0052	2 Amp fuse and holder
EM052U100	Owner's Manual
EM052U500	Quick Reference Guide

OPTIONAL ACCESSORIES

ACCESSORIES - PARTS NAME - ITEM			
	Q7000619A 50 Channel GPS Antenna with 30 feet rooting cable		DST521 600W Transom mount depth, speed temp Transducer
	ACVC10 Video Adapter cable		DST523 600W 2" Bronze Thru-hull depth temp Transducer
	VGAC10 VGA Adapter cable <i>(only for CPN1010i)</i>		DST525 600W In-hull Transducer
	ACAC10 Audio Output Adapter cable		DST526 600W 2" Bronze Thru-hull depth, speed temp Transducer
	FF525 50/200kHz Black Box Fish Finder		DST527 1000W In-hull depth Transducer
	DST520 600W 2" Nylon Thru-hull depth temp Transducer		DST528A 1000W Bronze long stem depth temp Transducer

GENERAL OPERATION

MANUAL CONVENTIONS

This Owner's Manual includes information for both the 7inch CPN700i and 10inch CPN1010i Multimedia Chart Plotters which are referenced to CPN Series Chart Plotters throughout this manual. In addition when a word(s) is bold and underlined it is referring to a menu selection on the display.

POWER UP SEQUENCE

1. Press the  PWR key until the display shows the Splash Screen page (see A). In case of error messages please refer to *System Update Error Messages* paragraph.





2. After about 1 minute the Splash Screen will change to show the Start Up Screen (see B). This page allows selection of the Chart Plotter, Media Player (video, audio and images), Internet Browser and Connection Manager (for **Wi-Fi**®, **Bluetooth**® and Ethernet setup). If a selection is not made within 30 seconds, the CPN Series Chart Plotter automatically changes to Chart Plotter Mode.

POWERING OFF

1. The CPN Series Chart Plotters have three operations. The GPS Chart Plotter Mode, Internet and Multimedia modes. When the CPN Series Chart Plotter is in any of these modes and the  PWR key is pressed and held, a Shut Down window will be shown:







2. To turn off the CPN Series Chart Plotter, tap on . To show the Start Up page tap on . To exit from the Shut Down menu, tap on .

BRIGHTNESS CONTROL

With the CPN Series Chart Plotter turned On, briefly press the  PWR key to show the brightness control window.











On the Brightness window, tap on  to increase or  to decrease the display backlight (or move the  ShuttlePoint Knob to the right or left); when finished, tap on  to save the selection and exit the brightness setting mode.

 The Brightness control is available also using the  Intelligent key.

CHART PLOTTER FRONT PANEL







- | | | |
|--|-------------------|--|
|  1 | Touchscreen | touch the screen to interact with the Chart Page, Menus, Internet or Multimedia modes. |
|  2 | MENU Key | selects the Main Menu |
|  3 | GOTO Key | shows the GOTO popup window and allows selection of Go To Cursor, Saved Mark or Route |
|  4 | CLEAR Key | cancels current operation |
|  5 | ROUTE Key | creates Waypoints to make a Route when on the Chart Page |
|  6 | MARK Key | places a Mark when on the Chart Page |
|  7 | ShuttlePoint Knob | moves the cursor on the Chart Page and to select items in menus |
|  8 | ZOOM Keys | change the scale of the chart to show a smaller or a wider area. |

- | | |
|--------------------|---|
| | When pressed allows the Rotary knob to be used to change zoom levels |
| 9 ROTATE Key | enables the chart to be rotated using the Rotary Knob |
| 10 CHART Key | opens a menu to change the chart from 2D to 3D and show vector, vector/sat, raster or satellite charts |
| 11 TILT Key | enables the chart to be tilted using the Rotary Knob |
| 12 Rotary Knob | used to enter a function or rotate, tilt and zoom In or Out the chart |
| 13 MOB Key | places a Man Overboard Mark |
| 14 Intelligent Key | opens a menu window to enable the Internet Browser or Media Player, and to show Brightness and Touchscreen Calibration too. |
-
- ! Internet cannot be accessed whilst in Chart Mode, however playing audio files using the multimedia player may be done simultaneously during Chart Plotter operation.
-
- | | |
|-----------------|---|
| 15 Power Key | turns On/Off the CPN Series Chart Plotter and adjust brightness |
| 16 SD Card slot | used to insert optional C-MAP 4D cartography, view pictures and listen to audio files loaded on optional card, save User Points and update software |

TOUCHSCREEN

The CPN700i and CPN1010i use a touchscreen display. Many functions are controlled by touching the display or using the dedicated keys, ShuttlePoint or Rotary Knobs.

The Touchscreen Calibration can be started from the Start Up screen by pressing and holding the  key for 5 seconds, or by pressing the  Intelligent key from any screen other than Setup. Once the calibration screen is displayed, you must tap on the center of the Cross-Hair as it moves around the screen, following the procedure shown. When completed and prompted press the ENTER key () ShuttlePoint Knob, see the following “*Selecting an item*” paragraph) to complete the calibration process and store the settings. Calibration mode may be exited without storing the settings by pressing the  key.

! Cleaning of the CPN Series Chart Plotter screen is a very important operation and must be done carefully. Since the surface is covered by an anti-reflective coating, the procedure for cleaning all the surfaces can be performed using the following procedure: use a clean, soft, lint-free cloth to clean the glass. We recommend using a micro-fiber cloth. Spray a small amount of ammonia-free cleaner (isopropyl alcohol) onto the cloth. Spraying on the cloth will prevent overspray. Fold the cloth or lens cloth into a triangular shape, moisten the tip and use the index finger behind a corner to move the cloth across the surface in overlapping side to side strokes. If the cloth is too wet, a noticeable wet film will be left in its path and you will need to repeat the process. If too dry, the cloth won't glide easily, and may damage the surface.

Below is a list of common functions accessed by touching the display:

- Menu items
- Page selection
- Keyboard input
- Page sweeping
- Scroll bar movements
- Panning the chart

- Pointing and manipulating objects on the chart (cartographic and user objects)
- Moving the cursor
- Chart rotation, Panning, Tilting and Zooming

① When touching an active object on the screen, the system provides a visual feedback to the show object has been touched (for example the object changes its color when touched).

The following gestures are recognized and interpreted:

- **Flick** (Page Sweeping): press a finger on the screen, quickly move the finger left or right, and then lift up the finger to initiate scrolling.
- **Pan/Move** (Scrolling maps, moving cursor): press and hold a finger on the screen and then drag the finger in any direction.
- **Tap** (Placing a cursor, activating Soft Keys, selecting objects/Data Boxes/options in menu): shortly press and release a finger on the screen.
- **Hold** (Opening additional related options context depended): press and hold a finger on the screen.

Touchscreen Keys

The keys that appear on the screen can be in four states:

- **NORMAL** : (BLUE BACKGROUND) key is not selected and not touched.
- **SELECTED** : (BLUE BACKGROUND WITH YELLOW FRAME) key is selected. The selection can be moved using the ShuttlePoint Knob; if the ShuttlePoint Knob or the Rotary Knob is pressed, the key related function is executed.
- **TOUCHED** : (RED BACKGROUND) key is touched with a finger. When a key is touched and released its related function is started.
- **DISABLED** : (GREY BACKGROUND) the function assigned to this key is not available at the moment.

Touchscreen Keyboard

A keyboard is used to enter/editing text of User Points or typing a URL when using the Internet Browser. The keyboard is also used for Internet Browser, MediaPlayer and Configuration Manager. The keyboard can be operated by the touchscreen or by moving the ShuttlePoint Knob. A character is entered (turns red) when the key is tapped once or when ShuttlePoint Knob is pressed.

Touchscreen Keyboard for Chart Plotter Mode

- 1 Edit line
- 2 Closes the keyboard without applying changes
- 3 Applies changes to the input sentence and closes the keyboard
- 4 Moves the selector in the edit field to the previous character in the sentence
- 5 Moves the selector in the edit field to the next character in the sentence

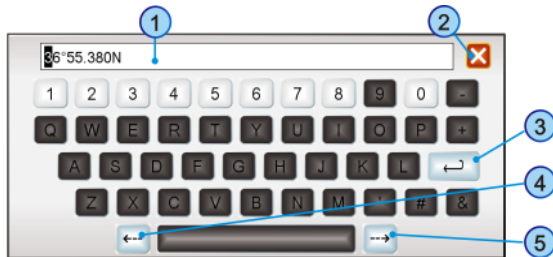

Touchscreen Keyboard for other applications

- 1 Places the Keyboard on bottom or top side of the screen
- 2 Select the character set:
(ABC abc 123 àéï)
- 3 Applies changes to the input sentence and closes the Keyboard

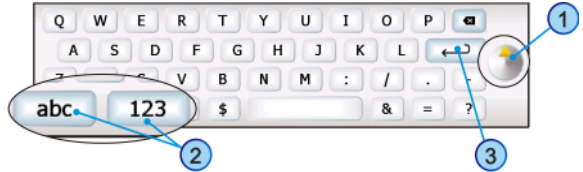

MENU DESCRIPTION

The menu window has the following elements.

- 1 8 Previous menu arrow
- 2 Menu name
- 3 Close window
- 4 Submenu selection (notice the arrow ▶)
- 5 Single menu item
- 6 Menu item list
- 7 Scroll bar

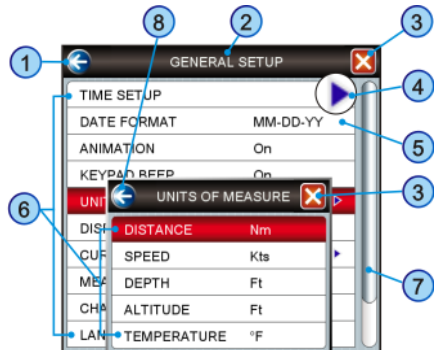

Refer to the previous picture:

- 1 and 8: a single touch on the arrow icon closes the current menu and displays the previous menu level. In the first menu level it closes the menu and goes back to the Main Menu page (in the example below 1 closes the General Setup menu and goes back to the Main Menu page. 8 closes the Units of Measure menu and displays the General Setup menu).
 - 3: when touched closes all menus.
-
- ! Touching 1 or 3 in the first menu level has no effect if there is a opened submenu.
- 6: list of all menu items present on the current menu level. There are two types of menu items: 4 opens the next menu level. 5 allows choosing one of available options.
 - 7: when touched up/down the bar, scrolls the content of the related window/page. See the following picture.

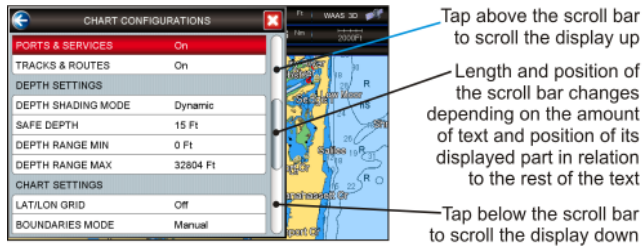

Warning Window

The Warning window will be shown to alert you of critical situations. For example:

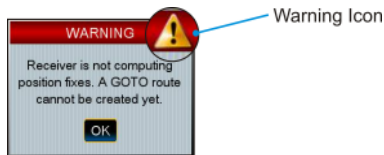

Tap on **OK** to close the Warning window.

Information Window

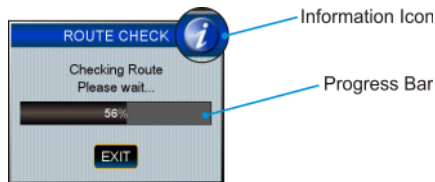

Above you can see an example of Information window that shows the CPN Series Chart Plotter is computing something. You can choose to wait until done or tap on **EXIT** on the display to exit.

SELECTING A ITEM

To select and activate a desired item:

- tap your finger on the display over the item
- or
- move the **+** ShuttlePoint Knob up/down to place cursor on the item and then press the **+** ShuttlePoint Knob (if enabled, see SHUTTLEPOINT ENTER item in “Settings in General Setup Menu” paragraph, “Chart Plotter” section)
- or
- move the **●** Rotary Knob left/right to place cursor on the item and then press the **●** Rotary Knob

Refer to the following example:

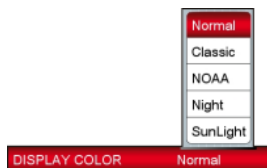

- A. Tap on **DISPLAY COLOR**. A popup window will be shown with the available options. To set Normal palette tap on **Normal**.
- or
- B. Move the **+** ShuttlePoint Knob up/down to highlight **DISPLAY COLOR** and press the **+** ShuttlePoint Knob. A popup window will be shown with the available options. To set Normal palette move the **+** ShuttlePoint Knob up/down to highlight **Normal** and press the **+** ShuttlePoint Knob.
- or
- C. Move the **●** Rotary Knob left/right to highlight **DISPLAY COLOR** and press the **●** Rotary Knob. A popup window will be shown with the available options. To set Normal palette move the **●** Rotary Knob left/right to highlight **Normal** and press the **●** Rotary Knob.

CHART PLOTTER CONTROLS

KEYS

The CPN700i and CPN1010i in addition to being able to control functions with the touch display, for your convenience dedicated keys and knobs are also provided. You will notice when a key is pressed a single beep will be produced which means the key press is valid. When a key press is not valid the CPN Series Chart Plotter will produce 3 beeps.

The key



- Press from any page in the Chart Plotter Mode to open the Main Menu.
- Press and hold for 3 seconds to allow you to change the fields contained within the data windows.
- ONLY FROM THE START UP SCREEN: Press and hold for 5 seconds to enable the Touchscreen Calibration mode.

The key

- When pressed, exits from a menu, from a selection, closes a Soft Key, changes from Cursor Mode to Home Mode or exits from a page to the Chart Page.

The key

ACTIVE ONLY IN CHART PLOTTER MODE

- While on the Chart Page, press the  key when you desire to Goto to a destination.
- When pressed, a popup window will be shown allowing you to start navigating to the position of the Cursor, a saved Mark or Route.
- To stop navigating, press the  key and tap on **STOP**.

The key

ACTIVE ONLY IN CHART PLOTTER MODE

- When a Chart Page is selected, pressing the  key places a Mark under the ship's position when in Home Mode, or under the cursors position.
- Pressing and holding for 3 seconds allows you to open the Marks/Wpt List page.

The key

ACTIVE ONLY IN CHART PLOTTER MODE









- When on Chart Page places a Waypoint under the vessel's or cursor position.
- Succeeding presses places additional Waypoints to form a Route.
- Pressing and holding for 3 seconds allows you to open the Edit Route page.

The ShuttlePoint Knob (joystick)

- Moves the cursor around the Chart Page (Cursor mode) and pans the chart.
- Used to scroll and select menu items. It changes the CPN Series Chart Plotter from Home Mode to Chart Mode on the chart screen.
- Press to select or enter a function (user selectable, see SHUTTLEPOINT ENTER item in "Settings in General Setup Menu" paragraph, "Chart Plotter" section).





The keys

ACTIVE ONLY IN CHART PLOTTER MODE

- Pressing the  key shows more detail of a smaller area, by changing the chart scale and zooming in on your display.
- Pressing the  key changes the scale and show a wider, otherwise less detailed view.
- Pressing and holding the  or  key allows for quick zoom, that is the fast change of the chart scale where only the land areas are drawn.
- the  or  key is released all map details are shown.
- the  or  key changes the Rotary Knob mode to zooming.

 The CPN Series Chart Plotters contains Built-In cartography for Alaska, Hawaii and Great Lakes, Canada, Bahamas, Caribbean, Cuba, Mexico, Puerto Rico, and Central America (Only for USA users). For more detail, a C-MAP 4D SD CARD must be purchased and installed.

The Rotary Knob

- Used to scroll and select menu items.
- Press to select or enter a function.
- Used together with the  or  key allows rotating or tilting the chart display both in 3D and in 2D mode.
- Used together with the  or  key allows zooming.

The key

ACTIVE ONLY IN CHART PLOTTER MODE

- To rotate the chart: press this key, then rotate the  Rotary Knob. The rotate angle ranges from 0 to 359 degrees.

The key

ACTIVE ONLY IN CHART PLOTTER MODE

- To tilt the chart: press this key, then rotate the  Rotary Knob. The tilt angle ranges from 90 to 11 degrees (90 is the view from the top). Clockwise rotation increases the tilt angle, counterclockwise rotation decreases the tilt angle.

The key



ACTIVE ONLY IN CHART PLOTTER MODE ON CHART PAGE ONLY

- Opens the CHART DISPLAY menu window from which you can select 2D Vector, Vector/Satellite, Raster or 3D Vector, Satellite or Raster modes.

 Optional C-MAP 4D cartography is needed to see Raster and Satellite details on the chart.

The key

ACTIVE ONLY IN CHART PLOTTER MODE

- When pressed, places a MOB (MOB = Man Over Board) mark on the Chart Page under the boat's position to aid in the rescue or a person that may have fallen aboard.
- To delete MOB, press the  key and then tap on  on the pop-up window.

The Intelligent key

- Exits the Chart Plotter Mode and shows a window to select a Internet Browser or play audio files, and to select Brightness and Touchscreen Calibration.
- PLAYING MUSIC in BACKGROUND (see following paragraph)

The PWR key (Brightness)

- Pressing and holding turns the CPN Series Chart Plotter On.
- Once On, pressing momentarily, shows the display brightness adjustment window.
- To turn Off, press and hold until the SHUTDOWN menu is shown, then tap on .

PLAYING MUSIC IN BACKGROUND (FOR CHART PLOTTER MODE ONLY)

It is possible to play audio files when in Chart Plotter Mode by pressing the  Intelligent key to access Media Player from the Chart Plotter Mode.

Once the Media Player is running as background application on the Chart Plotter Mode, the

 Intelligent key can toggle between the Chart Plotter and Media Player and back.

 The Media Player is the only application that can be activated from the Chart Plotter Mode. It is not possible to enter the Internet Browser when the Media Player and the Chart Plotter are both active.

Starting to play in background

To play music in background when running Chart Plotter Mode, follow the procedure below:

1. While Chart Plotter Mode is running, press the  Intelligent key. A pop-up window with the options Browser and Multimedia is shown.

2. Tap on Multimedia Icon . The Media Player is opened.

3. Choose a song to play, adjust the play mode and volume (see Media Player section for more information).
4. Press the **I** Intelligent key to go back to Chart Plotter Mode. The Media Player is hidden but it is active (music is playing) and the Chart Plotter Mode is shown again.
Pressing the **I** Intelligent key toggles between Media Player and Chart Plotter Modes.

Stopping to play

To stop music in background when running Chart Plotter Mode, follow the procedure below:

1. While Chart Plotter Mode is running, press the **I** Intelligent key.
2. Tap on **X** in Media Player Mode. Media Player is closed completely (without closing Chart Plotter) and the Chart Plotter Mode is shown again.

SOFT KEYS (FOR CHART PLOTTER MODE ONLY)

The CPN Series Chart Plotters have Soft Keys which are show on the display when:

- **Chart Page**

The cursor is moved over the top of a item (Mark, Waypoint, Route, chart object1...)

I Only if the Auto Info option is enabled, see the "Settings in General Setup Menu" paragraph, "Chart Plotter" section.

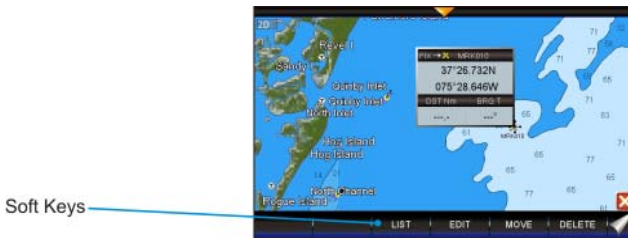

Soft Keys

- **Chart Page**

Touch and hold the Page Change Key (refer to the image below) to show Soft Keys to access other pages.



Soft Keys

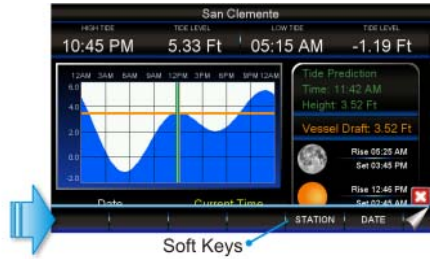

Page change Soft Key

- **Other Pages** (Tide, Highway, Compass, GPS and Fish Finder Pages)
Tap anywhere on the page to show the Soft Keys:



Closing Soft Keys

The Soft Keys are closed in the following ways while in Chart Plotter Mode:

- will automatically be removed if the display is not pressed from more than a specific timeout user selectable (see the Home Mode Revert setting in the “*Settings in General Setup Menu*” paragraph, “*Chart Plotter*” section).
- by tapping on the Close Soft Key control .
- by pressing the  key.

MEMORY DEVICES SAFELY REMOVAL

To replace an SD CARD with no chart data or a USB memory stick remove the device and wait at least 7 seconds before inserting the new one.

To remove an SD CARD with chart data during the CPN Series Chart Plotter working follow the procedure described in the Chart Plotter section.

CHART PLOTTER



GETTING STARTED

This section takes you through the most frequently used operations and shows how to customize the appearance of the CPN Series Chart Plotter.

1. Press the  PWR key until the display shows the Splash Screen page (see A). In case of error messages please refer to *System Update Error Messages* paragraph.





2. After about 1 minute the Splash Screen will change to show the Start Up Screen (see B). This page allows you to select the Chart Plotter, Connection Manager, Internet Browser or Multimedia modes.

3. To select the Chart Plotter mode, tap on the Plotter Icon .

The CPN Series Chart Plotter will automatically change to Chart Plotter Mode if a key or display is not touched for 30 seconds.

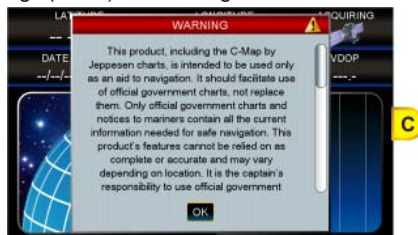
4. The Splash Screen page (see A) is shown again before the Warning page appears (see C).



Move the  ShuttlePoint Knob down or touch underneath the scroll bar to read the

Warning page. Tap on **OK** to accept the terms. Other Warning pages might appear, tap on **OK** to confirm.

! ONLY FOR USA: If Built-In Charts are out of date other warning pages are displayed.

- When a CPN Series Chart Plotter is first turned on it will take some time for the GPS to acquire a fix of your position. During this time the GPS Status Page (see *D*) will be shown. This page shows signals strengths and locations of GPS satellites. After a fix is received the page will be changed to show the vessel's position on the Chart Page (see *E*).



- After the Chart Page is shown (see *E*), the vessel will be show in the center of the display. CPN Series touch display operations:
 - Single tap: move the cursor to a location
 - Swipe (touch and drag finger): pan the chart to see a different area on the chart
 - Quick swipe (touch and quickly drag finger): change pageThe **+** ShuttlePoint Knob when moved will change the location of the cursor. When the cursor reaches the edge of the chart, the chart will pan.
- When you move the **+** ShuttlePoint Knob you will notice DST and BRG values in the Cursor window change. This shows the Distance and Bearing from the GPS Fix of your vessel to the position of the Cursor.

SWITCHING BETWEEN MODES

Default Mode

The Chart Page in 2D Vector is the default page. The Ship Icon (position fix) is in the center of the screen (Home Mode): as the ship moves through the water the vessel's position will be kept in the center of the display.

Home vs Cursor Mode

By default the CPN Series Chart Plotter shows the vessel in the center of the display which is called Home Mode. To change from Home Mode to Cursor Mode, touch the display or move the **+** ShuttlePoint Knob.

Cursor Mode

In Cursor Mode the Cross-Hair **+** is shown on the chart. To exit this mode so the Boat Icon stays in the center of the chart press the **CLEAR** key.

Cursor Mode allows you to pan around and look at areas on the chart. In this mode you can also create Marks, Routes, measure distance and bearings from your current position. The CPN Series Chart Plotter will automatically exit from Cursor Mode to Home Mode if the display or a key is not pressed for a user selectable time. The timeout depends on the Home Mode Revert setting in the General Setup menu (see “Settings in General Setup Menu” paragraph, “Chart Plotter” section). Default is 1 minute.

Switching between 2D and 3D modes

There are two methods to toggle between 2D and 3D modes:

1 From Main Menu

1. The Chart Page in 2D mode is shown (see A). Press the **MENU** key, tap on the large **Setup Menu** icon.
2. Tap on the small **DISPLAY** icon on the Desktop. The Chart Display menu appears (see B).

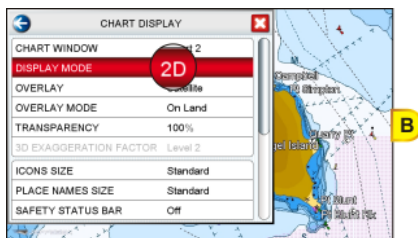
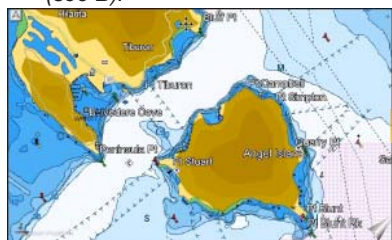

3. Tapping on **DISPLAY MODE** selects between **2D** and **3D**.
4. When 3D has been selected (see C), press the **CLEAR** key to exit from menu. The screen shows the Chart Page in 3D (see D).

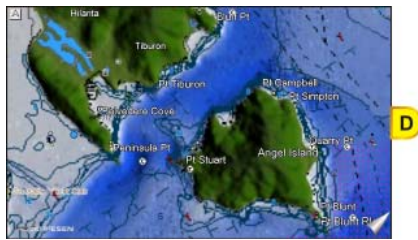

2 Using the **CHART** key

1. The Chart Page in 2D mode is shown (see A).

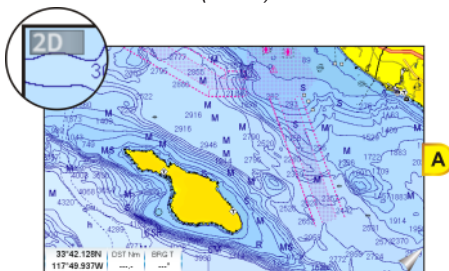

Press the **CHART** key: the following menu appears (see B).

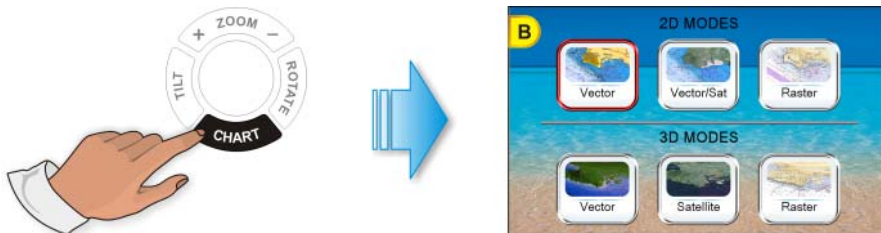

2. To select the 3D mode tap on a desired 2D or 3D icon among the available ones.
3. As soon as the desired 3D icon has been tapped (see C), the screen shows the selected Chart Page in 3D (see D).

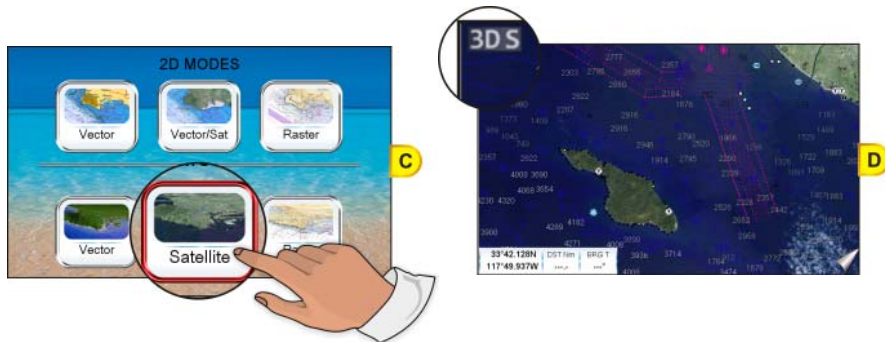

MENU SYSTEM

The CPN Series Chart Plotters have a unique menu system which allows you to select a page and see subpages on a desktop to make choices quick and easy. See the following examples of how to select a page:

1 Dual Chart example

1. Press the **MENU** key from any page.
2. Tap on the large **Chart** icon (see A) to select a page.
3. Tap on the small **DUAL** icon (see B) on the Desktop to show the Dual Chart page (see C).

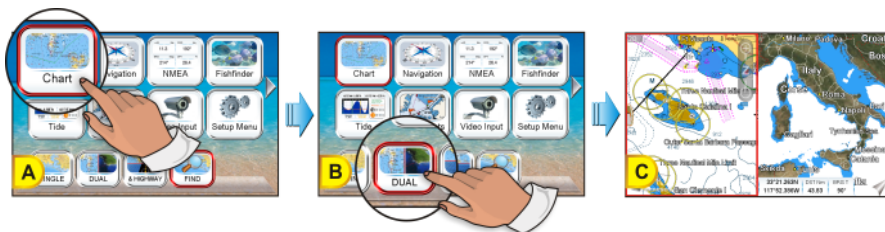

2 Setup Menu example

1. Press the **MENU** key from any page.
2. Tap on the large **Setup Menu** icon (see A) to select a page.

3. Tap on the small **GENERAL** icon (see B) on the Desktop to show the General Setup page (see C).



INITIAL SETUP

Cursor and Menu selection speed

The CPN Series Chart Plotter allows you to control the speed the Cursor moves on the chart and in menus using the **+** ShuttlePoint Knob. The default setting is Medium, to change the speed follow the procedure below:

1. Press the **MENU** key, tap on **Setup Menu** (see A).
2. Tap on **GENERAL** (see B). The General Setup menu appears (see C).



3. Tap on **CURSOR SPEED**. The menu now shows two selections, Chart and Menu which allow the Cursor Speed to be selected as High, Medium or Low on the Chart Page or within the menus.
4. Tap on **CHART** or **MENU**.

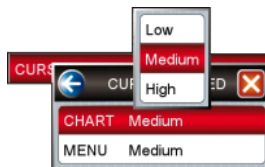

5. Tap on **Low**, **Medium** or **High** to set the desired speed.
6. Press the **CLEAN** key repeatedly until the menu disappears.
7. Move the cursor on the Chart Page and see if the speed is to your liking.

Changing the Ship Icon

The Ship Icon may be changed to one of the following icons for Sail or Power:

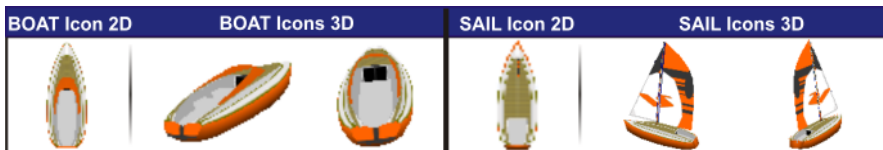

This setting also controls what type of a ship bow is displayed on the Highway page. The default setting is Power boat. To select the Ship Icon you want follow the procedure:

1. Press the **MENU** key, tap on **Setup Menu** (see A).
2. Tap on **DISPLAY** (see B). The Chart Display menu appears.
3. Move the **+** ShuttlePoint Knob down or turn the **●** Rotary Knob or touch underneath the scroll bar until **SHIP ICON** is selected (see C).



4. Tapping on **SHIP ICON** selects between **Power boat** and **Sail boat**.
5. When the item you want has been selected, press the **CLEAR** key to exit from menu.

Selecting Course Up/North Up

The default selection is Course Up: the top of the Chart Page orientated so it always shows the area ahead of the direction your vessel is travelling. Also it is possible to select North Up: the chart is shown with North toward the top of the display.

1. Press the **MENU** key, tap on **Setup Menu**.
2. Tap on **DISPLAY**. The Chart Display menu appears.
3. Move the **+** ShuttlePoint Knob down or turn the **●** Rotary Knob or touch underneath the scroll bar until **COURSE UP/NORTH UP** is selected.
4. Tap on **COURSE UP/NORTH UP** to toggle to the desired selection.
5. Press the **CLEAR** key or tap on **X** to save the selection.

Pages Selection

There are three methods to change a page:

1 From Main Menu

1. Press the **MENU** key, the Main Menu appears.
Tap on the desired Page icon (in the following example **Navigation**, see A), the related Desktop icons appears.



2. Tap on the desired Desktop icon (in the example above **COMPASS**, see B). The Compass page appears (see C).

2 Sweep

1. Press and hold a finger on the display until a double arrow icon is shown (see A).



2. Without removing your finger, slide it to the left or to the right until the arrow turns white (see B), then remove your finger from the display to change to another page (see C and D).

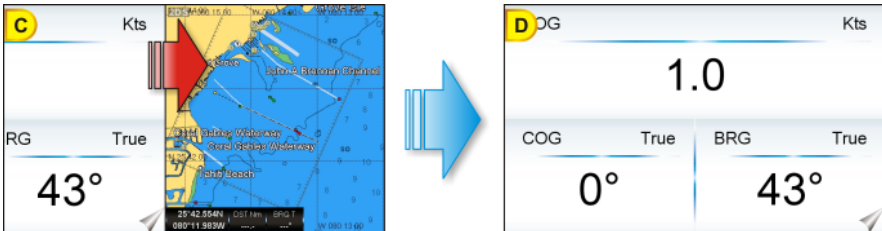

3 Page Change Icon

The Page Change Icon  is displayed on every page and it is used for two actions:

- **Single tap:** changes to the next page. In the example below a single tap on the Page Change Icon changes to the Compass page.



- **Long press:** shows the page Soft Keys. To change the page, tap on the desired Soft Key, refer to the image below: tap on the **COMPASS** Soft Key to change to the Compass page.



! The pages defined on the Soft Keys are used to define the page change cycle.

Assigning Page Soft Keys

The default pages are:

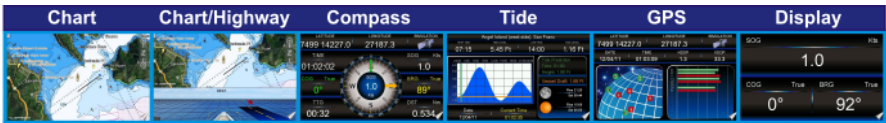

The page Soft Keys can be individually customized from the default pages:

1. To change, press and hold the Page Change Key  (see A) until Soft Keys are shown, then remove your finger.
2. Press and hold the page Soft Key you want to customize (see B). A popup window will be shown with the available pages (see C).



3. Touch the desired page to select and assign the page to the Soft Key.

Time Setup

The time information supplied by the GPS satellites is in Universal Time Coordinates (UTC or Greenwich Mean Time). To change the CPN Series Chart Plotter to read the correct time, first you must figure out the offset and if it is Daylight Saving Time. For example on the West coast of the United States or Pacific Standard Time the offset needed would be $-08:00$ or $-07:00$ for Daylight Saving Time, Eastern Standard Time $-05:00$ or $-04:00$ for Daylight Saving Time. The Time Setup menu allows you to enter a time zone offset for your location, selection to automatically adjust the time for Daylight Saving and to configure the time in 12 or 24 hour formats.

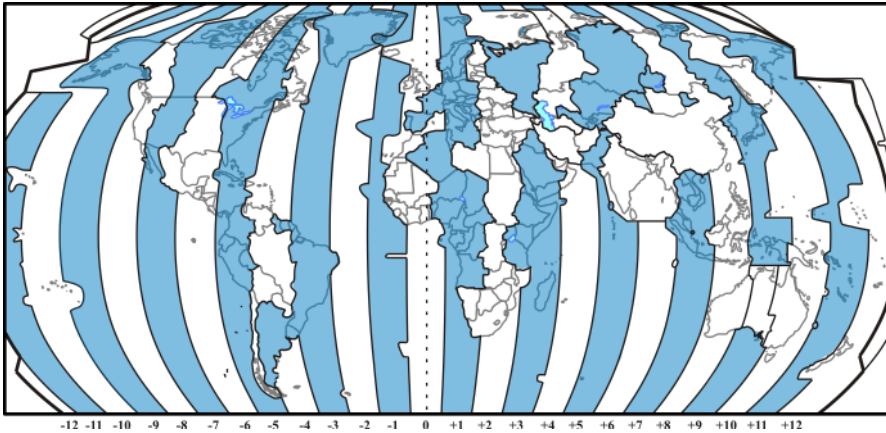

1. Press the **MENU** key, tap on **Setup Menu**.
2. Tap on **GENERAL**. The General Setup menu appears.
3. Tap on **TIME SETUP**. The Time Setup menu appears.

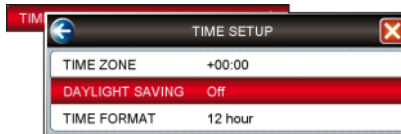

4. Tap on **TIME ZONE**.



5. Look at the table and find the time zone for your area. Tap under the bar (rotate the ● Rotary Knob or move the ⊕ ShuttlePoint Knob) to select the desired zone and tap on it.
6. Tap on **DAYLIGHT SAVINGS** to toggle between **Off** (select Off when your location does not recognize Daylight Saving Time) or **On** (select On to manually turn Daylight Saving Time On. This is the default selection).
7. Tap on **TIME FORMAT** to toggle between **12 hour** or **24 hour** (military) format.
8. Tap on **X** to exit the menu and show the last selected page.

ⓘ By setting the time in the steps above, the time shown on the Tide page is automatically set up.

Selecting Coordinate System

GPS Coordinates may be changed to show Latitude/Longitude (default ddd.mm.mmm), Loran TDs or UTM. To change the Coordinate System, follow the procedure below:

1. Press the **MENU** key, tap on **Setup Menu**.
2. Tap on **ADVANCED**. The Advanced Setup menu appears.
3. Tap on **NAVIGATE**. The Navigate menu appears.
4. Tap on **COORDINATE SYSTEM**.

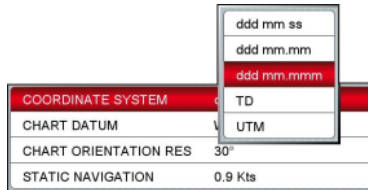

5. Tap on the desired coordinate type.
6. Press the **CLEAR** key 3 times to show the last selected page.

Loran TD

1. Press the **MENU** key, tap on **Setup Menu**.
2. Tap on **ADVANCED**. The Advanced Setup menu appears.
3. Tap on **NAVIGATE**. The Navigate menu appears.
4. Tap on **COORDINATE SYSTEM**.
5. Tap on **TD**.

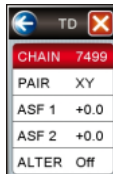

6. Tap on **CHAIN** and turn the **Rotary Knob** to select the Chain then tap on the number.
7. Tap on **PAIR** and turn the **Rotary Knob** to select the Pair then tap on the letters.
8. Press the **CLEAR** key 3 times to show the last selected page.

! If the TD numbers are not show correctly on the Chart Page, the Pair letters may be backwards. Reversing the two letters usually solves this issue. Example Y/Z change to Z/Y.

Changing the Display Color

The CPN Series Chart Plotter has preprogrammed settings allowing you to customize the look of the pages. The default is Normal.

1. Press the **MENU** key, tap on **Setup Menu**.
2. Tap on **GENERAL**. The General Setup menu appears.
3. Tap on **DISPLAY COLOR**. A popup window will be shown with the available options **Normal**, **Classic**, **NOAA**, **Night** and **Sunlight**.

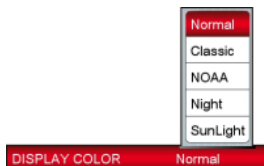

4. Tap on the desired selection.
5. Tap on  to exit the menu and show the last selected page.

In the pictures A and B you can see examples of charts and Compass page with the Display Color set to Normal.



In the pictures C and D you can see the same examples with the Display Color set to SunLight.

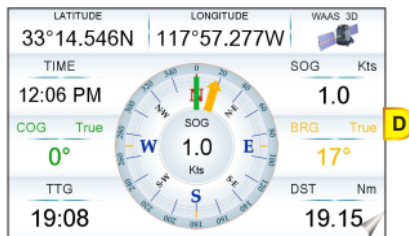

Selecting Language

To ease operation in different countries, the CPN Series Chart Plotters include translations in the following 16 Languages:

- English
- German
- Swedish
- Danish
- Finnish
- Japanese
- Italian
- Spanish
- Portuguese
- Dutch
- Russian
- French
- Norwegian
- Chinese (Traditional)
- Greek
- Chinese (Simplified)

Multilanguage will display the digitized data in the charts as long as the source paper chart was done in the national language. For instance, if a Chinese chart is done in English, the digitized data will only display in English. However, if it was done in Chinese, then the digitized data can display Chinese or English. The translations are included in menus, data pages, warning/alarm messages, full/quick info, list of objects found by find/nearest function, and on charts (such as place's names and buoy's names and so on).

To select the language you want:

1. Press the **MENU** key, tap on **Setup Menu**.
2. Tap on **GENERAL**. The General Setup menu appears.
3. Move the **+** ShuttlePoint Knob down or turn the **●** Rotary Knob or touch underneath the scroll bar until **LANGUAGE** is selected.
4. Tap on **LANGUAGE**. Another popup window will be shown with the available languages.

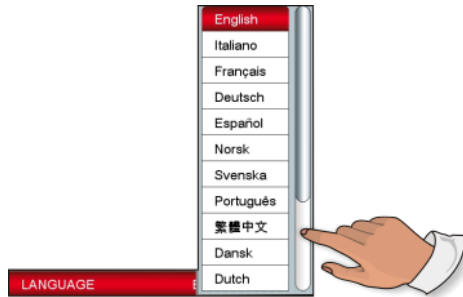

! To see additional languages, tap under bar or move the **+** ShuttlePoint Knob down or turn the **●** Rotary Knob.

5. Tap on the language you want.
6. Tap on **X** to exit the menu and show the last selected page.

! If the selected language is not available on cartographic data, English is used.

Chart Control Icon

When the Chart Page is selected a transparent icon (see A) is shown. This icon allows control of Zooming, Tilting, Rotating and controlling the Transparency and Exaggeration Factor¹ when optional C-MAP charts are used.

! Available only in 3D mode.

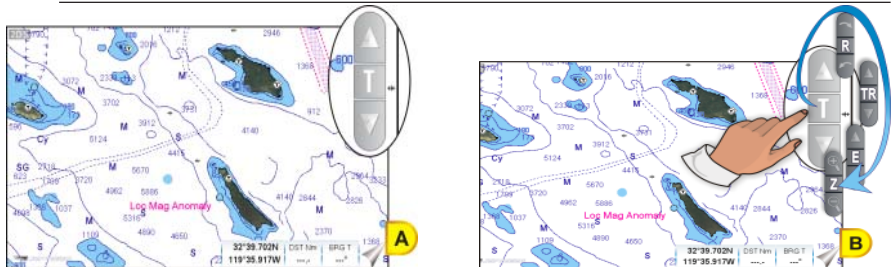

Tap on the centre of the Chart Control Icon (see B) it is possible to select the desired icon among the available ones, see the table below:

ZOOM	TILT	ROTATE	TRANSPARENCY	EXAGGERATION FACTOR

The default setting of the Chart Control Icon is Shown Permanent, however this may be changed by the procedure below:

1. Press the **MENU** key, tap on **Setup Menu**.
2. Tap on **GENERAL**. The General Setup menu appears.
3. Turn the **Rotary Knob** until **CHART CONTROL ICON** is highlighted.
4. Tap on **CHART CONTROL ICON**.
5. Tap on **SHOWN**.
6. The menu shows **Off**, **2 Seconds**, **5 Seconds**, **10 Seconds** and **Permanent**. Tap on the item you want.
7. Press the **CLEAR** key repeatedly until the menu disappears.

The default place of the Chart Control Icon is on the right top side, however this may be changed by the procedure below:

1. Press the **MENU** key, tap on **Setup Menu**.
2. Tap on **GENERAL**. The General Setup menu appears.
3. Turn the **Rotary Knob** until **CHART CONTROL ICON** is highlighted.
4. Tap on **CHART CONTROL ICON**.
5. Tapping on **LOCATION** selects between **Left** and **Right**.
6. When the item you want has been selected, press the **CLEAR** key repeatedly until the menu disappears.

SETTINGS IN GENERAL SETUP MENU

The General Setup menu has other selections that allow you to customize the display. All selections are listed in the following table:

TIME SETUP	Selects the Time Zone offset , enable or disable Daylight Savings time , selects the Time Format and switch between 12 or 24 hours time format.
DATE FORMAT	Selects the Date format among MM-DD-YY (default), DD-MM-YY or YY-MM-DD .
PAGE SWEEP	Selects among Animated (default), Normal and Off the swipe control to change page.
KEYPAD BEEP	Allows the beep produced when a key is pressed to be turned On (default) or Off .
SHUTTLE POINT ENTER	ShuttlePoint Knob press is user selectable. When set to On (default), pressing the ShuttlePoint Knob in the center is equal to confirm action. When set to Off , pressing the ShuttlePoint Knob in the center will not produce any effect.
UNITS OF MEASURE	Units of Measure can be selected for Distance , Speed , Depth , Altitude and Temperature : Distance : selections are Nm (Nautical Miles), Sm (Statue Miles), Km (Kilometers), Nm+Ft , Nm+Mt . Note when "Nm+Ft" is selected if the distance is less than 1.0 Nm, it turns to Feet. When "Nm+Mt" is selected if the distance is less than 1.0 Nm, it turns to Meters. Speed : selections are Kts (knots), MPH (miles per hour), Kmh (kilometer per hour). Depth : selections are Ft (feet), FM (fathoms) and Mt (meters). Altitude : selections are Ft (feet) and Mt (meters). Temperature : selections are F (Fahrenheit) and C (Celsius).
DISPLAY COLOR	Changes the background colors to enhance the visibility of the screen depending on the surrounding light conditions. Normal (default) is recommended when the CPN Series Chart Plotter is not exposed to the direct sunlight. When this mode is set the charts are displayed in order to use colors as similar as possible to ones used in the original paper charts. Night is recommended when the environment is dark in order to reduce the glare of the display. Sunlight is designed to enhance the visibility of the screen when the CPN Series Chart Plotter is exposed to sunlight. Classic uses vivid chart colors presentation. NOAA allows setting NOAA paper chart colors presentation.
CURSOR SPEED	Selects the speed among Low , Medium (default) and High for the cursor in the CHART page and within the MENU.

MEASURE DISTANCE

When this function is **On**, tap (or move the  ShuttlePoint Knob) on a location where you want to start measuring a distance (see *A*). Tap on a second location where you want to finish measuring a distance. A line appears between the Start and Finish points and a popup window will be shown indicating the distance and bearing from the Start and Finish points (see *B*). Tap on the **DELETE** Soft Key to delete both points. The default setting is **Off**.

START point

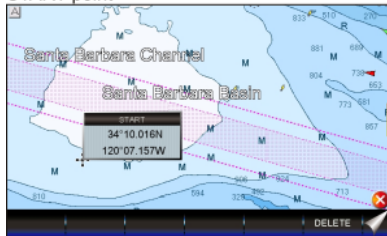

FINISH point

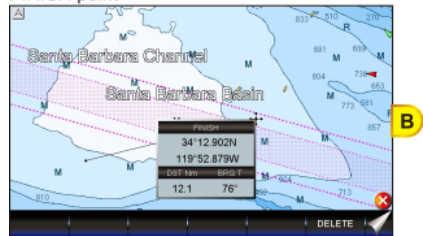

CHART PAGE WINDOW

Allows selection of data windows. Selections are **None**, **General**, **1 Line Small**, **1 Line Large** and **2 Lines Small** (default). The data windows may be customized (see “Customizing Data Windows” paragraph in “Main Menu” section) and may be collapsed or shown to show more or less chart area (see “Collapsing Data Windows” paragraph in “Main Menu” section).

LANGUAGE

Allows changing the language for menus and data screens. English is the default.

AUTO INFO

When the cursor is moved over a buoy, Mark or other item a popup window will show information of the item. This menu item allows the window to be turned **Off**, **On Points** (default) or **On All**.

HOME MODE REVERT

Sets the timeout (among **10 sec**, **30 sec**, **1 min** (default), **2 mins**, **5 mins** and **Off**) after which the CPN Series Chart Plotter goes back from Cursor Mode to Home Mode.

CURSOR WINDOW

By default when the cursor is moved on the chart a window is shown with the Lat/Lon Distance and Bearing from the vessels location to the cursor. This selection allows the window to be turned **On** (default) or **Off**. It appears only on the Chart pages (Single, Dual and Chart/Highway). The Cursor Window is automatically disabled when General is set in Chart Page Window option.

CHART CONTROL ICON

Opens a menu with two items:

SHOWN: the chart control touchscreen icon can be permanently shown (default) or it can be shown for a while (timeout) when the keyboard is touched. Select the timeout among **2 sec**, **5 sec**, **10 sec**, **Permanent** and **Off**.

LOCATION: the chart control touchscreen icon can be shown on the **Right** (default) or **Left** top side of the screen.

BUILT-IN CHARTS

AVAILABLE ONLY FOR USA Enables (**On**) or disables (**Off**) the Built-In Charts. The default is **On**.

CARTOGRAPHY OVERVIEW

BUILT-IN CHARTS --- AVAILABLE ONLY FOR USA

The CPN Series Chart Plotters have Built-In Charts for coastal navigation with the following characteristics (refer to the following image for coverage area of Built-In Charts).

- Coverage: USA including Alaska, Hawaii and Great Lakes, Canada, Bahamas, Caribbean, Cuba, Mexico, Puerto Rico, and Central America. Fresh water coverage is not included. Detailed coverage and Fresh waters charts are available from Jeppesen.
- Depth contours and Spot Soundings to 66 Feet (20 meters) on lower scale charts and

33 Feet (10 meters) on higher scale charts.

- Port Info: basic information for Marinas and the list of services symbols.
- Selectable Tide Page showing Tidal information, moon and sun rise and set times.
- All Nav-Aids with icon and description
- 2D standard nautical vector cartography
- Guardian Alarm is not available while using only the Built-In Charts

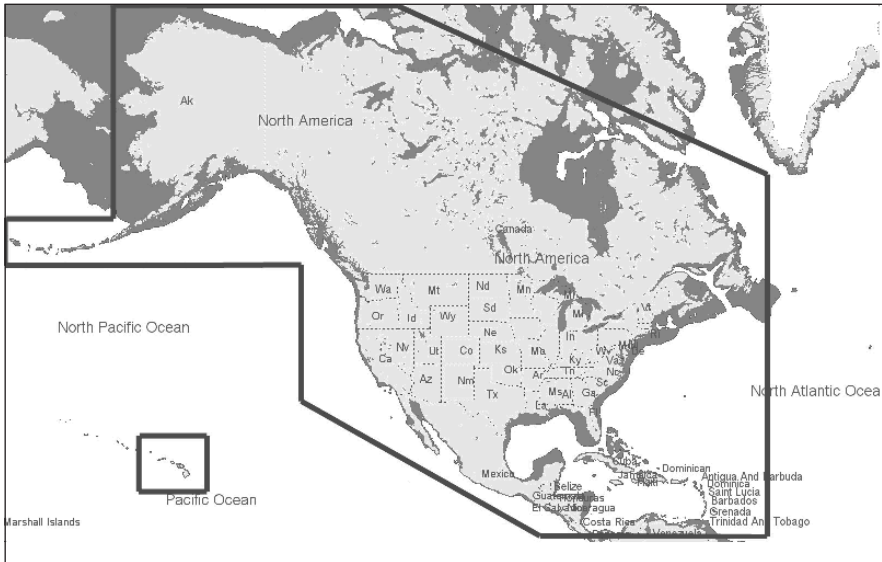

To use all Marina information along with 2D and 3D Raster and satellite imagery a C-MAP 4D CARD must be purchased and installed.

Updating Built-In Charts

The Built-In Charts can be updated by purchasing a Chart Update Card from C-MAP USA at (800) 424-2627. This Chart Update Card may be used ONE time to update the charts in a CPN Series Chart Plotter. After the updating, the Chart Update Card will not update other CPN Series Chart Plotters. To purchase the Chart Update Card you must supply the UNIT ID code. This code is found on the About Page, refer to the procedure below:

1. Press the **MENU** key, tap on **Setup Menu**.
2. Tap on the right arrow next to ADVANCED Desktop icon two times to display **ABOUT** and tap on it.
3. The About Page appears on the screen, refer to the picture below:

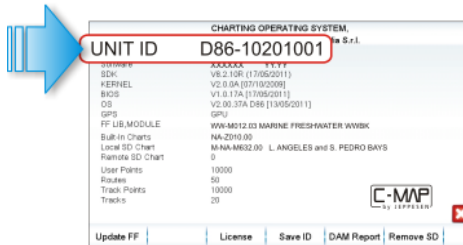



The Chart Update Card will be use ONLY on the CPN Series Chart Plotter with that UNIT ID code.

After purchasing the Chart Update Card, follow the procedure to update the charts.

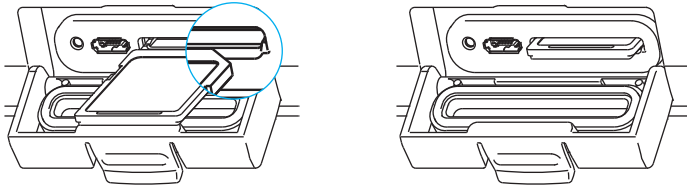
1. Press the  PWR key to turn the CPN Series Chart Plotter Off.
2. Insert the Chart Update Card into the slot.



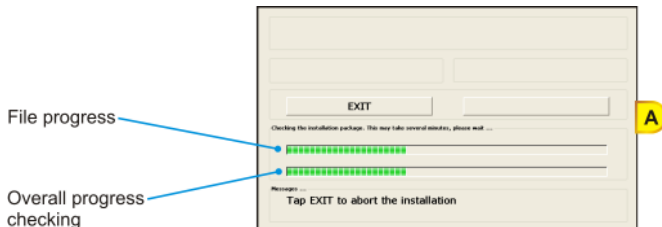

3. Press and hold the  PWR key to turn the CPN Series Chart Plotter On.
4. The package update window appears (see A). The CPN Series Chart Plotter checks the integrity of the Installation Package present on the Chart Update Card. This operation might require several minutes (if you want to abort the installation tap on ).



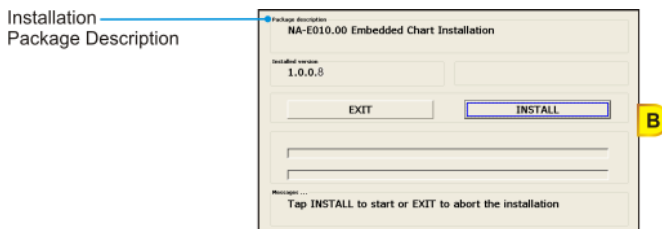

At the end of the checking, the package update window shows the following data (see B):





The  touchscreen key is now selected (it appears with blue frame).

 If case of error message, press the  PWR key to turn the CPN Series Chart Plotter Off and then follow steps 3-4 again. If the CPN Series Chart Plotter shows a error message again, contact C-MAP USA at (800) 424-2627 for assistance.

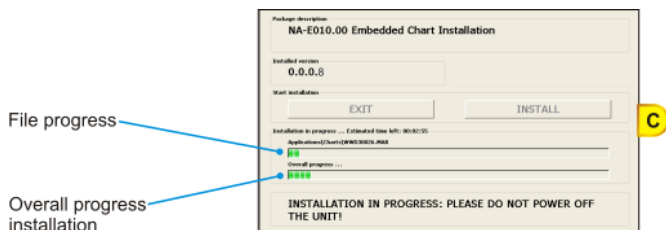
5. Tap on  to start installation (or tap on  to abort).
6. The installation process begins. Pay attention: do not turn the CPN Series Chart Plotter Off during installation. The installation status appears in the two progress bars on the bottom of the package update window (see C):



7. At the end of the installation process, the Start Up Screen is shown.
8. To complete the Built-In Charts update procedure, press the  PWR key to turn the CPN Series Chart Plotter Off and remove the Chart Update Card from the slot.
9. Then press and hold the  PWR key to turn the CPN Series Chart Plotter On: the Built-In Charts are updated and ready to use.

 In case of error messages please refer to *System Update Error Messages* paragraph.

C-MAP 4D

DIGITAL NAVIGATION CHARTS THAT GROW WITH YOUR BOATING NEEDS

To learn more go to <http://www.jepesen.com/main/corporate/no-wpr/c-map-4d/index.jsp>

C-MAP 4D is the only maritime chart plotting solution that lets you completely customize your digital navigation charts and has the capability of adding new marine chart data as it becomes available.

First, choose either the **MAX** or **Full 4D** content on your cartridge. Should you start out with MAX and decide at a later date to upgrade to the full 4D content, simply use the same cartridge to purchase and unlock the additional technology. C-MAP 4D allows you to unlock or add Value Added Data (to either MAX or 4D content) as they become available.

General Features

- **ISO Certification:** electronic chart production process with quality certification ISO 9001.
- **Official data source:** data based on use of official data sources Hydrographic Offices Release.
- **Detailed World Background:** worldwide background chart with details, satellite and 3D data on selected zoom ranges.

Data Features

- **Search & Find:** quickly locates chart contents and objects - Tide Station, Port Info, Port by Name, Wrecks, Obstructions, Lake name/info, POI.
- **Port Info:** searchable data base of service in Ports.
- **Object Info:** moving cursor over object to show restricted area details and related information.
- **Quick Info:** moving cursor over Wrecks, shoals, Nav-Aids to show restricted area details and related information and object to show details.
- **True-Type Font:** improves text on chart for optimal reading.

Presentation Features

- **Clear View:** advanced legibility techniques providing more chart data on the screen
- **Clear Info:** sophisticated "Human Dictionary" to translate Nav-Aid abbreviations found on paper charts.

- **Enhanced Mixing Levels:** seamless data presentation.

C-MAP 4D: MAX Content

- **Nav-Aids:** detailed information on Navigational Aids, including name, color, information on frequency, range of the light, etc.
- **Guardian Alarm:** the Guardian Alarm is a user defined area in front of your vessel to alert you while navigating of possible obstacles on the chart. When activated, Guardian Alarm performs an automatic forward-scanning check for obstacles.
- **Safety Status Bar:** a status bar with six boxes to show the status of certain functions. Any warning or alarm condition is identified by the red color to indicate possible risk.
- **Safe Route Check:** sophisticated function that checks for dangerous objects along your navigation route.
- **C-Marina Port Database:** complete port and marina charts with detail.
- **Multilanguage capability:** allows showing language of your choice in using proper character set for Asian and other countries.
- **Tides Preview:** allows viewing of current, future and past tide cycles from worldwide Tide Stations database.
- **Dynamic Currents:** current arrows showing speed and direction of current, future and past currents.
- **Photos & Diagrams:** high definition pictures of ports, piers, bridge diagrams and Nav-Aids.
- **Depths & Land Elevation:** color shading of sea depth and land altitude for improved chart appearance.
- **Perspective view:** for a bird's-eye view of your navigation area.
- **Points Of Interest (POIs) and road mapping:** searchable data base of detailed information that include facilities and services in ports and surrounding areas.

C-MAP 4D: FULL 4D Content

All above and in addition:

- **3 Dimensional Chart View:** the world has three dimensions. When you add the 4th dimension of time – meaning consistent, periodic updates – you combine the most detailed 3D height and depth worldwide database with a continuous update process to give you a personalized navigation experience with up-to-date data for safe navigation.
- **Satellite Images with 2D and 3D overlay:** C-MAP 4D includes a navigational perspective with high-resolution coastal imagery overlaid on the most accurate and up-to-date vector data, plus thousands of extraordinary photos for the most popular marinas and areas of interest.
- **Digital Raster Chart:** with raster charts, you have an additional reference source for navigational awareness. Get “at-a-glance” information using the nautical paper charts overlaid on 2D and 3D views on multi-dimensional shaded relief to have a new visual experience.
- **Easy Routing:** automatic creation of a Route. Enter start and end points along with specific boat parameters and automatically receive Waypoints of the shortest Route; highlights potential hazards and displays varying levels of alerts for each segment of the route, allows you to manually adjust the route.

C-MAP 4D: Value Added Data

New additional data or service to standard cartography available (High Resolution Bathymetry, weather, etc). You can enable or disable the display of the category as a whole or of each individual.

- **High Resolution Bath charts & Spot Soundings:** Data Base with high resolution bathy information for an extraordinary view of the seabed depth.

VALUE ADDED DATA MENU

The VAD Menu is a multiple options menu with the information present on the optional C-MAP 4DCARD. Value Added Data are divided into categories; inside each category there is a set of objects. Some of the VAD categories are free and some others have to be purchased. You can enable or disable the display of the category as a whole or of each individual object inside the category.

- each category has a separate submenu
- each category has a On/Off/Custom settings available:
 - **On** switches the display of all object in the category on
 - **Off** switches it off
 - **Custom** allows to set each object separately in the submenu

To select the VAD menu follow the procedure:

1. Press the **MENU** key, tap on **Setup Menu**.
2. Tap on **VAD**. The VAD menu appears on the screen.



REMOVING A SD CARD

To safely remove the SD CARD follow the procedure:

1. Press the **MENU** key, tap on **Setup Menu**.
2. Tap on the right arrow next to ADVANCED Desktop icon two times to display **ABOUT** and tap on it. The About Page appears on the screen.
3. Tap anywhere in the About Page to display Soft Keys on the bottom of the page.
4. Tap on the **REMOVE SD** Soft Key.
5. Tap on **CONFIRM** in the popup window, then on **CLOSE** on the next window.
6. Open the door, gently remove the SD CARD from the slot.
7. Press the **CLEAR** key to exit.

USING FIND SERVICES

! This function finds only the cartographic objects which are been set to visible (On) in the menu.

It is possible to search the Built-In Charts¹ and the optional C-MAP 4D SD CARD for Port Services, Ports, Tide Stations, Wrecks, Obstructions, Points Of Interest, Lakes, User Points, GPS Coordinates or Information on any point on the Chart.

! ONLY FOR USA.

! The amount of information might be due to the optional C-MAP 4D charts installed.

1. Press the **MENU** key, tap on **Chart**.
2. Tap on **FIND**. The Find Services & More menu appears.



PORT SERVICES

This feature is used to locate Port Services nearest the position of your vessel. The following table shows a list of some of the available Port Services and icons shown on the Chart Page:

HEALTH EMERGENCY	HARBOUR MASTER	COAST GUARD	ENGINE REPAIRS	FUEL STATION	WATER	PROVISIONS	CAR PARKING	SEWERAGE PUMP-OU...	PUBLIC TELEGRAPH	PUBLIC RADIO	TRANSPOR... SERVICES
ELECTRICITY	POLICE	CUSTOMS... POLICE	BOAT YARD	ACCESSOR... ELECTRON...	ELECTRICAL... REPAIRS	COMMERCIAL FISHING SE...	OTHER MARIN...	TOWING SERVICES	PORT PARTNER	BAIT/TACKLE SHOP	OFFICE SERVICE
SAILMAKER	FISHING/DI... GEAR,SCU...	PHARMACY	SLIPWAY	BOAT HOIST	CRANE	NEWSSTAND	CHARTER	LAND BASED VESSEL ST...	AIRPORT	HULL REPAIRS	SPORT ACTIVITY
CHANDLER	BOTTLE GAS	PARKING FOR BO...	YACHT CLUB	HOTEL/INN	RESTAUR...	BOAT RENTAL	FLOODOUT BERTHS	INTERNET POINT	FIRST AID	BOUTIQUE	BAR
BANK/EXC... OFFICE	SHOWERS	LAUNDRE...	PUBLIC TOILETS	PUBLIC TELEPHONE	REFUSE BIN	WATCHING SERVICE	DIVERS	MOORING SERVICE	PROMISSION DELIVERY		

1. Press the **MENU** key, tap on **Chart**.
2. Tap on **FIND**. The Find Services & More menu appears.
3. Tap on **PORT SERVICES**. A popup window will be shown with a list of different Port Services (see A).
4. Move the **+** ShuttlePoint Knob or touch the screen to highlight the desired type of

service and tap on **SELECT**. Another popup window will appear displaying the distance and position of the Port Services closest to your location (see B). Otherwise tap on **CLOSE** to exit.

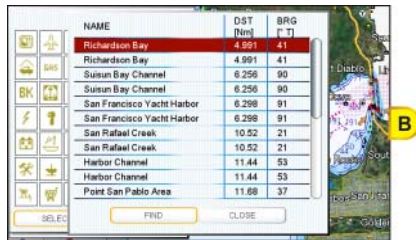

- Use the **+** ShuttlePoint Knob to highlight the desired Port Service and tap on **FIND**. This will show information about the service (see C). Otherwise tap on **CLOSE** to exit.

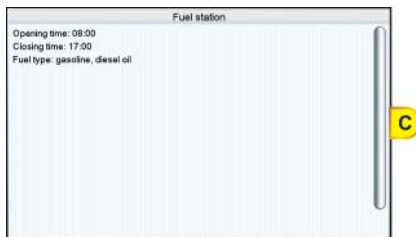

- Press the **CLEAR** key to show the actual position of the service on the Chart Page.
- Press the **CLEAR** key again at any time to return your cursor to your vessel's position.

PORT

A Port is represented with a **L** on the Chart Page. This feature is used to locate the 20 nearest Ports to the position of your vessel.





- Press the **MENU** key, tap on **Chart**.
- Tap on **FIND**. The Find Services & More menu appears.
- Tap on **PORT**. A popup window will be shown with a list of nearest Ports (see A).
- Move the **+** ShuttlePoint Knob to highlight the desired Port and tap on it.
- Tap on **FIND** to show the details of the Port (see B), otherwise tap on **PORT BY NAME** to search the Port by inserting the name. Tap on **CLOSE** to exit from Port function.







- Press the **CLEAR** key at any time to return your cursor to your vessel's position.

TIDE STATIONS

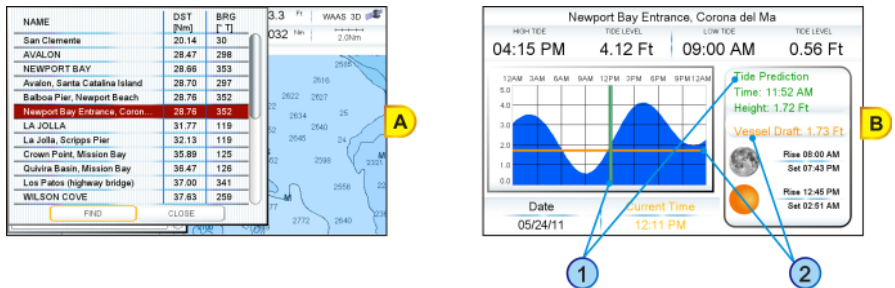
A Tide Station is represented with a  on the Chart Page. This feature is used to locate the 20 nearest Tide Stations to the position of your vessel. Once a Tide Station is selected the Tide Graph can be used to determine Tide height and draught of the Tide based on a user-specified time.

1. Press the  key, tap on **Chart**.
2. Tap on **FIND**. The Find Services & More menu appears.
3. Tap on **TIDE STATIONS**. A popup window will be shown with a list of nearest Tide Stations (see A).
4. Move the  to highlight the desired Tide Station and tap on it.
5. Tap on  to show the detail of the Tide Station (see B).
6. Press the  key at any time to return your cursor to your vessel's position.





Refer to the image (B) above. Moving the  left and right controls the Tide Prediction time  and moving the  up or down controls the Vessel Draft value .

 The Local Offset matches the Time Offset entered in the Time Setup menu.

Changing the day

1. Tap anywhere on the Tide page.
2. Tap on the **DATE** Soft Key (see C).
3. Enter the date using the touchscreen keyboard. When finished tap on , the keyboard disappears.

Changing Tide Station

1. Tap anywhere on the Tide page.
2. Tap on the **STATION** Soft Key (see C).
3. Tap on the desired Tide Station in the menu (see D).
4. Tap on  to show the new Tide information or tap on  to exit the menu.

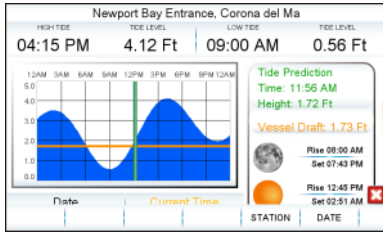

NAME	DST (Nm)	BRG (° T)	Tide Level
San Clemente	20.14	30	0.56 Ft
AVALON	28.47	298	
NEWPORT BAY	28.98	353	
Avalon, Santa Catalina Island	28.70	297	
Balboa Pier, Newport Beach	28.78	352	
Newport Bay Entrance, Corona	28.78	352	
LA JOLLA	31.77	119	
La Jolla, Scripps Pier	32.13	119	
Crown Point, Mission Bay	35.89	125	
Quivira Basin, Mission Bay	36.47	126	
Los Patos (highway bridge)	37.00	341	
WILSON COVE	37.63	258	

WRECKS

This feature is used to locate the 20 nearest Wrecks to the position of your vessel. A Wreck is represented with an icon on the chart, see the following table:

ICON	DESCRIPTION
++	non-dangerous wreck
⊕	dangerous wreck
# [Foul]	distributed remains of wreck
⊕ Masts	wreck showing mast/masts
✈	wreck showing any portion of hull or superstructure

1. Press the **MENU** key, tap on **Chart**.
2. Tap on **FIND**. The Find Services & More menu appears.
3. Tap on **WRECKS**. A popup window will be shown with a list of nearest Wrecks (see A).
4. Move the **+** ShuttlePoint Knob to highlight the desired Wreck or tap on it.
5. Tap on **FIND** to show the location of the Wreck (see B).
6. Press the **CLEAR** key 2 times to revert to your vessel's position.

NAME	DST (Nm)	BRG (° T)
Wreck	8.017	255
Wreck	8.017	255
Wreck	8.017	255

Wreck

Category of wreck: wreck (non-dangerous)
Water level: always under water/submerged

OBSTRUCTIONS

This feature is used to locate the 20 nearest Obstructions to the position of your vessel. An Obstruction is represented with an icon on the chart, see the following table:

ICON	Obstrn	Mast (1,2)	#	#	#	#	# [Foul]	Obstrn	
DESCR.	snag / stump	wellhead	diffuser	crib	fish haven	foul area	foul ground	ice boom	ground tackle

1. Press the **MENU** key, tap on **Chart**.

2. Tap on **FIND**. The Find Services & More menu appears.
3. Tap on **OBSTRUCTIONS**. A window is shown with a list of nearest Obstructions (see A).
4. Move the **+** ShuttlePoint Knob to highlight the desired Obstruction or tap on it.
5. Tap on **FIND** to show the location of the Obstruction (see B).

NAME	DST (Nm)	BRG (°T)
Obstruction	10.71	333
Obstruction	10.71	333
Obstruction	10.71	333
Obstruction	11.74	228
Obstruction	11.74	228
Obstruction	11.74	228

Obstruction
Depth: 798.22 Feet
Water level: always under water/submerged

6. Press the **CLEAR** key 2 times to revert to your vessel's position.

LAKES INFORMATIONS

A Lake Info is represented with a **i** on the Chart Page. This feature is used to find information on the 20 closest Lakes near the position of your vessel.

1. Press the **MENU** key, tap on **Chart**.
2. Tap on **FIND**. The Find Services & More menu appears.
3. Tap on **LAKES INFORMATION**. A window is shown with a list of Outdoor Recreational Area objects (see A).
4. Tap on the desired object and tap on **SELECT**. A window appears displaying the distance and position of the Lakes closest to your location (see B).

NAME	DST (Nm)	BRG (°T)
Big Bear Lake	84.03	36
Castaic Lake	91.29	338
Lake Piru	91.44	333
Lake Castias	103.8	317
Lake Cachuma	133.4	311
Isabella Lake	154.9	351
Lake Nacimiento	217.2	317
Milerton Lake	248.5	340
Camanche Reservoir	330.9	334
Folsom Lake	370.7	335

NAME	DST (Nm)	BRG (°T)
Big Bear Lake	84.03	36
Castaic Lake	91.29	338
Lake Piru	91.44	333
Lake Castias	103.8	317
Lake Cachuma	133.4	311
Isabella Lake	154.9	351
Lake Nacimiento	217.2	317
Milerton Lake	248.5	340
Camanche Reservoir	330.9	334
Folsom Lake	370.7	335

5. Move the **+** ShuttlePoint Knob to highlight the desired Lake or tap on it.
6. Tap on **FIND** to show the location of the Lake (see C).

Fishing
Information: Trout (Rainbow), Trout (Lake), Trout (Golden), Trout (Cutthroat), Trout (Bull), Trout (Brown), Trout (Brook), Salmon (Kokanee), Salmon (Coho), Salmon (Chinook), Perch (Yellow), Perch (White), Crappie (White), Crappie (Black), Catfish (White), Catfish (Flathead), Catfish (Channel), Catfish (Blue), Carp (Common), Bullhead (Yellow), Bullhead (Brown), Bullhead (Black), Bass (White), Bass (Spotted), Bass (Smallmouth), Bass (Largemouth), Arctic Grayling

7. Press the **CLEAR** key 2 times to revert to your vessel's position.

QUICK AND FULL INFO ON LAKES

Upon viewing the chart of a lake, you can tap on the Lake Info icon (see A) to query the available information immediately displayed with many details. When the cursor is placed over this icon (and the Auto Info option is allowed) the Quick Info window appears: the icons of the available services are shown (see B).

LAKES INFO Icon

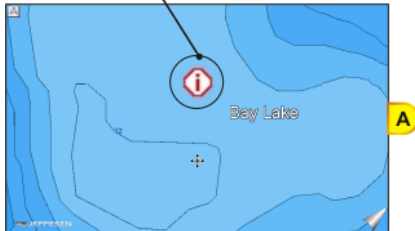

To see the "Fishing" object tap on the **IMAGE** Soft Key (see C). Tap on the **EXPAND** Soft Key to obtain the Full Info on Lakes: all available information about the cartographic point under the cursor will be shown (see D).

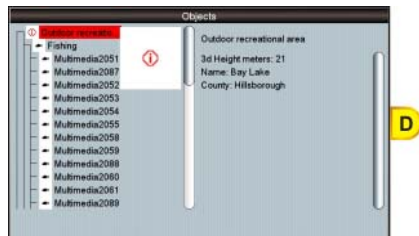
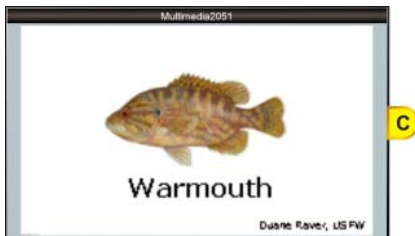

LAKES BY NAME

This feature is used to locate Lakes By Name nearest the position of your vessel.

1. Press the **MENU** key, tap on **Chart**.
2. Tap on **FIND**. The Find Services & More menu appears.
3. Tap on **LAKES BY NAME**. A window will be shown with a list of nearest Lakes (see A).



Now you can browse the list (step a) or enter the Lake name (step b):

- a. Browse the list and tap on the desired Lake.

- b. Tap on **LAKE NAME** to enter the desired Lake name. The touchscreen keyboard appears, it will allow you to enter in the name of the Lake you wish. Insert the desired name; when finished tap on **↵**, the keyboard disappears. Another window will appear displaying the distance and position of the Lake. Tap on the desired Lake.
4. Tap on **FIND** to show the Information on the Lake (see B). Tap on the **IMAGE** Soft Key or on the **EXPAND** Soft Key to obtain the Full Info on Lakes: all available information about the cartographic point under the cursor will be shown.

POINTS OF INTEREST

This feature is used to locate Points Of Interest nearest the position of your vessel.

1. Press the **MENU** key, tap on **Chart**.
2. Tap on **FIND**. The Find Services & More menu appears.
3. Tap on **POINTS OF INTEREST**. A (Category) popup window will be shown with a list of Category types (i.e. attractions, emergency, entertainment).
4. Tap on the desired Category. A (Type) popup window will be shown with a list of types (see A).
5. Tap on the desired Type. A popup window will be shown with a list of nearest Points Of Interest that fall into the Category and Type you have selected (see B).

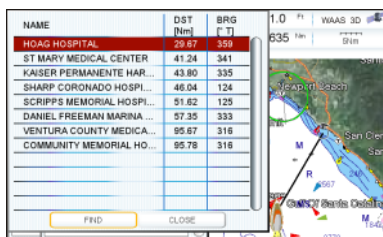

6. Tap on the desired Point Of Interest.
7. Tap on **FIND** to show the location of the Point Of Interest information (see C).

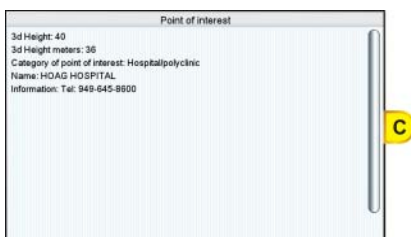

8. Press the **CLEAR** key 2 times to revert to your vessel's position.

USER POINTS

This feature is used to search for User Points (Marks and Waypoints you have created and stored) by name quickly and efficiently.

1. Press the **MENU** key, tap on **Chart**.
2. Tap on **FIND**. The Find Services & More menu appears.
3. Tap on **USER POINTS**. The touchscreen keyboard appears, it will allow you to enter in the name of the User Point you wish to locate. Insert the desired name; when finished tap on **↩**, the keyboard disappears. The screen shows the location of the User Point on the Chart Page.
4. Press the **CLEAR** key 2 times to revert to your vessel's position.

COORDINATES

This feature allows you to enter Coordinates (Latitude/Longitude) and view the entered position on the Chart Page.

1. Press the **MENU** key, tap on **Chart**.
2. Tap on **FIND**. The Find Services & More menu appears.
3. Tap on **COORDINATES**. The touchscreen keyboard appears, it will allow you to enter in a specified Latitude and Longitude. Once the Coordinates are entered tap on **↩**, the keyboard disappears. The screen shows the desired location on the Chart Page.
4. Press the **CLEAR** key 2 times to revert to your vessel's position.

INFORMATIONS

This feature allows you to obtain information on any position on the Chart page.

1. Press the **MENU** key, tap on **Chart**.
2. Tap on **FIND**. The Find Services & More menu appears.
3. Turn the **Rotary Knob** to select **INFORMATION**.
4. Tap on **INFORMATION** to show the page below:

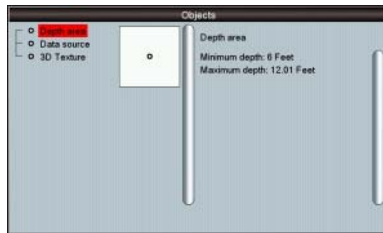

The left side of the page contains the Info Tree and the right side contains the expanded information. While tapping on the left side page moving through the Info Tree, all the relevant information of the selected object is shown on the right part of the page.

5. Press the **CLEAR** key 3 times to exit to the Chart Page.

CHART DISPLAY FUNCTIONS

The Chart functions menu can be accessed using the Main Menu as shown below:

1. Press the **MENU** key, tap on **Setup Menu** (see A).
2. Tap on **DISPLAY** (see B). The Chart Display setup appears (see C) divided in two sections, one related to the 4D functions and another for generic chart display.



4D FUNCTIONS

Chart Window

This function selects the window that will be affected by the 4D related settings (see the following paragraphs). Each chart window has its own settings so, when Chart Window item is changed, all relevant settings are updated accordingly. The two available selections are Chart1 (default, applies to Single Chart and to the left chart window in Dual Chart) and Chart2 (applies to the right chart window in Dual Chart).

To activate this function follow the procedure:

1. Press the **MENU** key, tap on **Setup Menu**.
2. Tap on **DISPLAY**. The Chart Display menu appears.
3. Tapping on **CHART WINDOW** selects between **Chart1** or **Chart2**.
4. Once the window is selected the options can be set for that chart. Tap on **X** to exit from menu.

Display Mode

This function allows to toggle among the (default) 2D (see A) and 3D (see B) modes to display the chart on the screen:

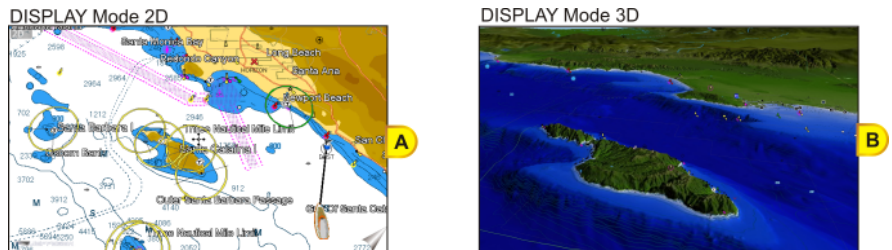

To activate this function follow the procedure:

1. Press the **MENU** key, tap on **Setup Menu**.
2. Tap on **DISPLAY**. The Chart Display menu appears.
3. Tapping on **DISPLAY MODE** selects between **2D** or **3D**.
4. When the item you want has been selected, tap on **X** to exit from menu.

Overlay

This function allows to overlay Satellite (default) image (see B), Raster Charts (see C), Vector (see A) or Chart Shading (see D) for background charts.

DISPLAY MODE 2D OVERLAY Vector



DISPLAY MODE 2D OVERLAY Satellite



DISPLAY MODE 2D OVERLAY Raster Charts

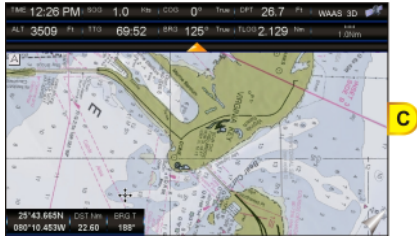

DISPLAY MODE 2D OVERLAY Chart Shading



! Chart Shading is available only in Display Mode 2D.

To activate this function follow the procedure:

1. Press the **MENU** key, tap on **Setup Menu**.
2. Tap on **DISPLAY**. The Chart Display menu appears.
3. Tap on **OVERLAY**.
4. The menu shows **Satellite**, **Raster Charts**, **Chart Shading** or **Vector**. Tap on the item you want.
5. Tap on **X** to exit to the Chart Page.

Overlay Mode

This function sets the overlay area of Satellite and Raster images. To activate this function follow the procedure:

1. Press the **MENU** key, tap on **Setup Menu**.
2. Tap on **DISPLAY**. The Chart Display menu appears.
3. Tap on **OVERLAY MODE**.
4. The menu shows **On Land** (default), **On Sea** and **On All**. Tap on the item you want.





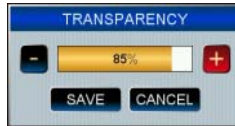

5. Tap on  to exit to the Chart Page.

Transparency

This function sets the transparency value between the vector chart and the layer over it (raster or satellite). To activate this function follow the procedure:

1. Press the  key, tap on **Setup Menu**.
2. Tap on **DISPLAY**. The Chart Display menu appears.
3. Tap on **TRANSPARENCY**.





4. A new window appears to insert the desired value (0 - 100). Tap on  or  to reach the desired value, then tap on  (tap on  otherwise). You can use the  to cycle between bar,  or .

 Available only if Overlay is Satellite or Raster Chart.

3D Exaggeration Factor

This function vertically stretches the land elevations and depths. It sets the 3D Exaggeration Factor among 5 levels. To activate this function follow the procedure:



1. Press the  key, tap on **Setup Menu**.
2. Tap on **DISPLAY**. The Chart Display menu appears.
3. Tap on **3D EXAGGERATION FACTOR**.
4. The menu shows **Level1**, **Level2**, **Level3**, **Level4** and **Level5**. Tap on the item you want.
5. Tap on  to exit to the Chart Page.

 Available only in 3D mode.

GENERAL CHART DISPLAY FUNCTIONS

Icon Size

It is possible to set the size of all icons drawn on the charts, selecting between Standard (default) and Large size. To activate this function follow the procedure:

1. Press the  key, tap on **Setup Menu**.
2. Tap on **DISPLAY**. The Chart Display menu appears.
3. Tapping on **ICONS SIZE** selects between **Standard** or **Large**.
4. When the item you want has been selected, tap on  to exit from menu.

ICON SIZE Standard

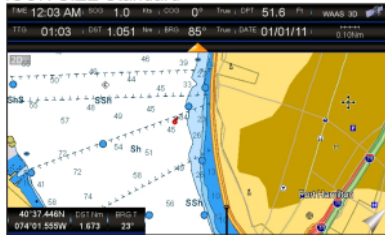

ICON SIZE Large



Place Name Size

It is possible to set the size of all names drawn on the charts, selecting between default Standard (see A), Medium (see B) and Large (see C) size.

PLACE NAMES SIZE standard



PLACE NAMES SIZE medium



PLACE NAMES SIZE large



To activate this function follow the procedure:

1. Press the **MENU** key, tap on **Setup Menu**.
2. Tap on **DISPLAY**. The Chart Display menu appears.
3. Tap on **PLACE NAMES SIZE**.
4. The menu shows **Standard**, **Medium** or **Large**. Tap on the item you want.
5. Tap on **X** to exit to the Chart Page.

Safety Status Bar (DSI - Data Safety Indicator)

When the Safety Status Bar is enabled, a status bar with six boxes shows the status of certain functions. Any warning or alarm condition is identified by the red color to indicate possible risk.



1 Normal: when the chart is displayed at normal scale.

U. Zoom: red when the chart is under-zoomed out more than twice normal scale, gray otherwise.

O. Zoom: red when the chart is over-zoomed in more than twice normal scale, gray otherwise.

No Chart: red when the chart is zoomed in more than twice normal scale, gray otherwise.



2 Red when a more detailed chart is available under the cursor position.

3 Red when at least one of the following objects or layers is turned off (by the user) Depths/soundings; Wrecks/obstructions; Tracks/routes; Attention Areas; Nav-Aids.

4 Displays red when clearing overlapping objects.

5 Red when "Guardian Technology" detects one of the following objects: Land, Intertidal, Depth Area, Rocks, Obstructions, Shoreline Constructions, Fishing Facility, Wrecks, Draged area, Diffusion area, Mooring facilities, Pingos and Production installations.

6 Red when "Guardian Technology" detects cautionary or restricted area.

To activate this function follow the procedure:

1. Press the **MENU** key, tap on **Setup Menu**.
2. Tap on **DISPLAY**. The Chart Display menu appears.
3. Tap on **SAFETY STATUS BAR**.
4. The menu now shows the following selections:
 - On:** The Safety Status Bar is shown
 - Off:** The Safety Status Bar is not shown
5. Tap on the desired selection.
6. Tap on **X** to exit to the Chart Page.

Icon: In this mode the Safety Status Bar is not shown, rather a Warning Icon  will be shown in the top right corner on the chart page when an alarm condition is met.

Currents Prediction

This feature only operates in areas where tidal buoys are present and when the CPN Series Chart Plotter has a GPS fix. Tidal stream arrows are shown on the charts, indicating the direction and strength of the Tide:



The color of the arrow denotes the strength of the current as follows:

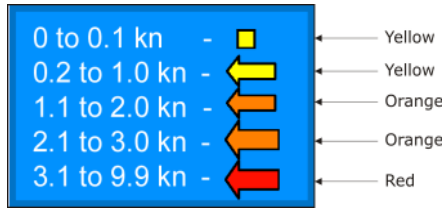

When the CPN Series Chart Plotter receives a valid position fix, the Tide icons are shown on the charts on the basis of the current date and time: the screen displays and changes arrows as date/time changes.

It is possible to see the variation of the Tidal arrows on the selected area at any given time.

To activate this function follow the procedure:

1. Press the **MENU** key, tap on **Setup Menu**.
2. Tap on **DISPLAY**. The Chart Display menu appears.
3. Turn the **Rotary Knob** to select **CURRENTS PREDICTION**.
4. Tap on **CURRENTS PREDICTION**.
5. Tap on the **SET TIME** Soft Key to set the date and time manually, and on the **INCR. TIME** / **DECR. TIME** Soft Keys to increase/decrease time; tap on the **EXIT** Soft Key to exit.

Chart Language

The CPN Series Chart Plotter may be customized to show the local language of the chart. To select the Chart Language you want:

1. Press the **MENU** key, tap on **Setup Menu**.
2. Tap on **DISPLAY**. The Chart Display menu appears.
3. Turn the **Rotary Knob** to select **CHART LANGUAGE**.
4. Tap on **CHART LANGUAGE**. A new window will appear with available functions described in the table.

Language	: Allows setting the language to display chart information. The language is chosen among the list of languages available on the cartographic data (data cartridge or embedded charts).
Mode	: Defines how objects are translated. Selections are: Off : Enables the language chosen in the Language menu above. If the selected language is not present on the objects information, English is used. English : Always uses English. Local : Uses the Local language present on C-MAP By JEPPESEN SD CARD. If no Local language is available, English is used.

5. Tap on **X** to exit to the Chart Page.

- !** a. When the Chart Language is changed, the following settings are automatically selected: MODE is set to Off and Chart Language is set to your selection.
 b. If the SD CARD is removed or changed, the Chart Language should be confirmed and changed if necessary.

Course Up/North Up

The default selection is Course Up: the top of the Chart Page oriented so it will always show the area ahead of the direction your vessel is travelling. Also it is possible to select North Up: the chart is shown with North upwards.

1. Press the **MENU** key, tap on **Setup Menu**.
2. Tap on **DISPLAY**. The Chart Display menu appears.
3. Turn the **Rotary Knob** to select **COURSE UP/NORTH UP**.
4. Tapping on **COURSE UP/NORTH UP** selects between **North Up** and **Course Up**.
5. When the item you want has been selected, tap on **X** to exit to the Chart Page.

Nav-Aids Presentation

Allows the Nav-Aids Presentation to be drawn using NOAA symbology when **US** (default) is selected or International symbols when **International** is selected. When selected these functions affect how the icons for Lights, Signals, Buoys and Beacons are displayed.

To activate this function follow the procedure:

1. Press the **MENU** key, tap on **Setup Menu**.
2. Tap on **DISPLAY**. The Chart Display menu appears.
3. Turn the **Rotary Knob** to select **NAV AIDS PRESENTATION**.
4. Tapping on **NAV AIDS PRESENTATION** selects between **ON** and **International**.
5. When the item you want has been selected, tap on **X** to exit to the Chart Page.

Ship Icon

This setting controls the type of a ship icon drawn on the Chart Page and the ship bow displayed on the Highway Page, and also sets the fix icon type displayed on the Chart Pages. The default setting is Power boat. See the following examples of Ship Icons:

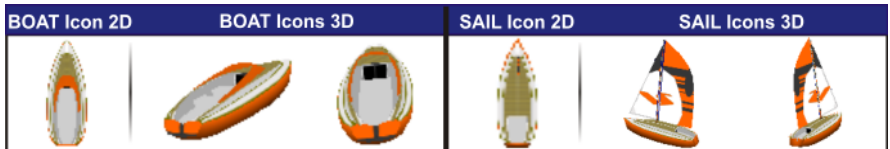

To select the Ship Icon you want follow the procedure:

1. Press the **MENU** key, tap on **Setup Menu**.
2. Tap on **DISPLAY**. The Chart Display menu appears.
3. Turn the **Rotary Knob** to select **SHIP ICON**.
4. Tapping on **SHIP ICON** selects between **Power boat** and **Sail boat**.
5. When the item you want has been selected, tap on **X** to exit to the Chart Page.

Course Time Line

It is a line projected from the ship icon which indicates the distance your vessel will travel at the current speed. Selections are 2, 10 (default), 30 minutes, 1, 2 hours and Infinite.



To activate this function follow the procedure:

1. Press the **MENU** key, tap on **Setup Menu**.
2. Tap on **DISPLAY**. The Chart Display menu appears.
3. Turn the **Rotary Knob** to select **COURSE TIME LINE**.
4. Tap on **COURSE TIME LINE**.
5. Tap on the item you want.
6. When the item you want has been selected, tap on **X** to exit to the Chart Page.

Compass Indicator

Allows selection of compass direction indication around ship icon. The default is Off.



To activate this function follow the procedure:

1. Press the **MENU** key, tap on **Setup Menu**.
2. Tap on **DISPLAY**. The Chart Display menu appears.
3. Turn the **Rotary Knob** to select **COMPASS INDICATOR**.
4. Tapping on **COMPASS INDICATOR** selects between **On** or **Off**.
5. When the item you want has been selected, tap on **X** to exit to the Chart Page.

Ship Icon Position

The position of the ship icon can be customized so it is centered in the middle (if **Center** selected, default setting) or centered on the bottom of the Chart page (if **Bottom** selected). It applies only to Home Mode.

To activate this function follow the procedure:



1. Press the **MENU** key, tap on **Setup Menu**.
2. Tap on **DISPLAY**. The Chart Display menu appears.
3. Turn the **Rotary Knob** to select **SHIP ICON POSITION**.
4. Tapping on **SHIP ICON POSITION** selects between **Center** or **Bottom**.
5. When the item you want has been selected, tap on **X** to exit to the Chart Page.

PICTURES & DIAGRAMS

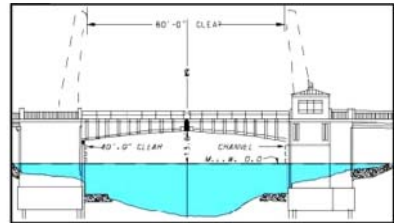
Using optional C-MAP BY JEPPESEN data SD CARDS allows you to show pictures or diagrams on the CPN Series Chart Plotter display. These *Pictures* are typically used to facilitate the identification of cartographic objects or places around the map: they can be the landscape layout nearby a harbor, the shape of a bridge or of a buoy etc. On some objects, such as bridges, the image associated can represent the *Diagram* representing the shape of the objects and the various characteristics (length, height, type of bridge etc.).



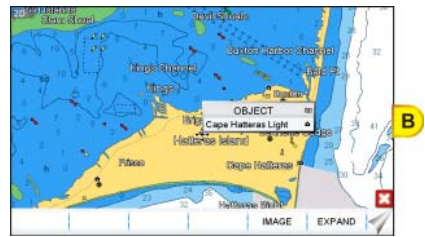

How to show the Pictures or Diagrams of a Object

They are shown on the Chart Page with the camera icon  (see A). Move the cursor over the camera icon by tapping on the display or using the  ShuttlePoint Knob. A Object popup window will be shown (see B).

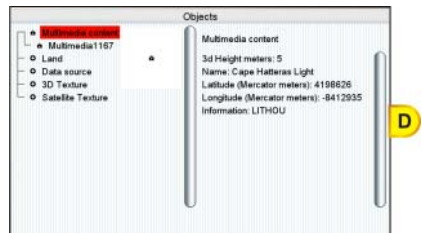

Tap on the **IMAGE** SoftKey to display the image on the screen (see C) or tap on the **EXPAND** Soft Key to open the Full Info on the object (see D).



Note that on the Full Info, there is the small camera icon on a corner of the square containing the object icon. To see the picture tap on the **IMAGE** SoftKey when the object with a picture is highlighted. When the picture is shown, tapping on it shows the associated Soft Keys. If there are more pictures to show, there will be the **NEXT** and/or **PREVIOUS** Soft Keys. Tap on the **CLOSE** Soft Key to exit, otherwise tapping on  the Soft Keys disappear.

CREATING MARKS

A User Point is an object that you can place on the charts to mark a specific point. The CPN Series Chart Plotter features two types of User Points: Marks and Waypoints.

- Mark can be a stand alone position or be linked to a Route. A Mark is place on the Chart Page using the **MARK** key or by entering in information in the Marks/Waypoints List page and tapping on **NEW MARK**.
- Waypoints are always liked to a Route. Are placed on the Chart Page using the **ROUTE** key.

- ❗ The difference between a Mark and a Waypoint is:
- a. when a Route is created using Waypoints and the Route is deleted the Waypoints are also deleted.
 - b. if a Route is created using Marks and the Route is deleted the Marks remain.

CREATING A NEW MARK USING THE CHART PAGE

1. Move the **+** ShuttlePoint Knob or tap the screen to the desired or approx. Lat/Lon and press the **MARK** key.
2. You will notice a Mark is placed under the location of the cursor and a popup window is shown with the exact Lat/Lon of the Mark.
3. If the position is incorrect, tap on the **EDIT** Soft Key which allows changing of the position, Mark name and icon type by tap on the position, Mark name or icon.

- 1 Mark placed under Cursor
- 2 Lat/Lon of Mark, DST/BRG from vessel location
- 3 Soft key to delete, to move, to edit a Mark or to show the Marks/Waypoint List (Directory)





- ❗ After entering in all the Marks it is a good practice to back up the points to a SD CARD.

EDITING A MARK OR WAYPOINT

1. Tap on the Mark or Waypoint you want to edit.
2. Tap on the **EDIT** Soft Key shows the Mark Edit popup window.



3. The Mark Icon appears selected, tap on it. The Mark Icons popup window appears.
4. Tap on the desired Mark Icon to select it. The Mark Icons window disappears.
5. Tap on the Mark Name. The touchscreen keyboard appears. Insert the desired name; when finished tap on , the keyboard disappears.
6. Tap on the Lat/Lon field. Again the touchscreen keyboard appears. Insert the desired coordinates; when finished tap on , the keyboard disappears.
7. Tap on  to store the Mark.

DELETING A MARK OR WAYPOINT

1. Tap on the Mark or Waypoint you want to delete.
2. Tap on the **DELETE** Soft Key. A warning popup window will be shown to confirm deleting the point.





3. Tap on  to confirm.

MOVING A MARK OR WAYPOINT

1. Tap on the Mark or Waypoint you want to move (see A).



2. Tap on the **MOVE** Soft Key.
3. Use the  ShuttlePoint Knob to move the cursor. A dotted line, connecting the previous Mark or Waypoint position to the new position, is shown (see B).
4. Tap on the new position (the  key to abort the move), the Mark or Waypoint appears (see C).

- ! There is also an easier way to start moving a Mark or Waypoint: press the **MARK** or the **ROUTE** key while cursor is over a Mark point or a Waypoint. Then tap on the desired position and press the **+** ShuttlePoint Knob.

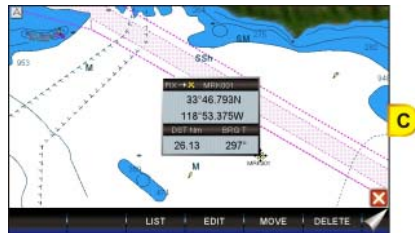

- ! If the CPN Series Chart Plotter was in 3D mode, it will automatically change to 2D mode and remain there after the change has been made.

MARKS/WAYPOINTS (USER POINTS) LIST

The Marks/Waypoints List page shows all the Marks and Waypoints that have been stored into the CPN Series Chart Plotter. To show the User Points List:

1. Press the **MENU** key, tap on **User Points**.
2. Tap on **MARKS**. The Marks/Waypoints List page will be shown.

MARKS / WAYPOINTS					
SYM	NAME	TYPE	LATITUDE	LONGITUDE	MODE
M	CHK003	MARK	33°58.843N	17.87	SHOWN
M	MRK001	MARK	118°50.200W	302°	SHOWN
M	MRK002	MARK	33°41.237N	48.85	SHOWN
M	MRK004	MARK	33°21.878N	7.382	SHOWN
M	MRK006	MARK	33°28.866N	2.185	SHOWN
M	MRK008	MARK	118°12.851W	189°	SHOWN
M	DEST	MARK	33°28.019N	5.713	SHOWN
			118°19.179W	205°	

ICON FIND LOCATE EDIT SORT NEW MARK
MODE DELETE DEL ALL SEND RECEIVE

This page also allows you to:

- ICON** Allows sorting by icon type. Selections are:
SELECT: only User Points with the selected icon are shown
ALL: all User Points are shown
- FIND** Searches through the Marks or Waypoints to find a point by name. The touchscreen keyboard appears to insert the desired name.
- LOCATE** Shows (locates) the position of a Mark or Waypoint on the Chart Page
- EDIT** Allows you to edit a previous stored Mark or Waypoint
- SORT** Allows sorting the name of User Points. Selections are:
A-Z ASCENDING: sorts the name of the Mark or Waypoint in ascending order
Z-A DESCENDING: sorts the name of the Mark or Waypoint in descending order
- NEW MARK** Creates a new Mark under the cursor position.
- MODE** This selection controls how the Marks or Waypoints are shown on the Chart Page. Selections are:
SHOW: icon and name are shown
ICON: only icon (no name) is shown
HIDE: Mark or Waypoint is hidden
SHOW ALL: all Marks or Waypoints are shown
ICON ALL: all Icons are shown without name

HIDE ALL: all Marks or Waypoints are hidden

- DELETE** Allows deleting the selected point. Tap on **YES** to confirm.
- DELETE ALL** Allows deleting all stored points. Tap on **YES** to confirm.
- SEND** Sends the stored points to an external device (PC) capable of listening to NMEA WPL and RTE sentences. A information window appears after sending completed. Tap on **OK** to confirm.
- RECEIVE** When selected, receives points from an external device (PC) that is capable of sending NMEA WPL sentence. A information window appears after receiving completed. Tap on **OK** to confirm.

! The SEND and RECEIVE functions are usually used by navigation programs running on a PC.

CREATING/MODIFY A NEW MARK IN THE USER POINTS LIST

! This function is very useful if you have a list of Marks that you want to enter into the CPN Series Chart Plotter.

1. Press the **MENU** key, tap on **User Points**.
2. Tap on **MARKS**. The Marks/Waypoints List page will be shown.
3. To create a New Mark, tap on **NEW MARK**. A row is added (see A).
4. Tap on **EDIT**. The Mark Icon appears selected (see B).

NEW ROW

MARKS / WAYPOINTS					
SYM	NAME	TYPE	LATITUDE LONGITUDE	DST(H) BRG(D)	MODE
+	MRK001	MARK	33°20.568N 117°58.100W	12.58 0°	SHOWN
+	MRK002	MARK	33°20.568N 117°58.408W	12.58 10°	SHOWN
+	MRK005	MARK	33°08.306N 117°41.142W	14.20 60°	SHOWN
+	WPT003	WPT	33°14.109N 118°41.705W	38.96 273°	SHOWN
+	WPT004	WPT	33°10.329N 119°00.415W	52.21 273°	SHOWN

ICONS: FIND, LOCATE, NEW MARK, MODE, DELETE, DEL ALL

MARKS / WAYPOINTS					
SYM	NAME	TYPE	LATITUDE LONGITUDE	DST(H) BRG(D)	MODE
+	MRK001	MARK	33°20.568N 117°58.100W	12.58 0°	SHOWN
+	MRK002	MARK	33°20.568N 117°58.408W	12.58 10°	SHOWN
+	MRK005	MARK	33°08.306N 117°41.142W	14.20 60°	SHOWN
+	WPT003	WPT	33°14.109N 118°41.705W	38.96 273°	SHOWN
+	WPT004	WPT	33°10.329N 119°00.415W	52.21 273°	SHOWN

ICONS: EDIT, SORT, NEW MARK, MODE, RECEIVE

5. Press the **Rotary Knob**¹. The Mark Icons popup window appears.
6. Tap on the desired Mark Icon (see C). The Mark Icons window disappears.
7. Turn the **Rotary Knob** to the right to select the Mark Name field and press the **Rotary Knob**. The touchscreen keyboard appears. Insert the desired name (see D); when finished tap on **↩**, the keyboard disappears.

MARKS / WAYPOINTS					
SYM	NAME	TYPE	LATITUDE LONGITUDE	DST(H) BRG(D)	MODE
+	MRK001	MARK	33°20.568N 117°58.100W	12.58 0°	SHOWN
+	MRK002	MARK	33°20.568N 117°58.408W	12.58 10°	SHOWN
+	MRK005	MARK	33°08.306N 117°41.142W	14.20 60°	SHOWN
+	WPT003	WPT	33°14.109N 118°41.705W	38.96 273°	SHOWN
+	WPT004	WPT	33°10.329N 119°00.415W	52.21 273°	SHOWN

ICONS: EDIT, SORT, NEW MARK, MODE, DELETE, DEL ALL, SEND, RECEIVE

MARKS / WAYPOINTS					
SYM	NAME	TYPE	LATITUDE LONGITUDE	DST(H) BRG(D)	MODE
+	SHARK	MARK	33°20.568N 117°58.100W	12.58 0°	SHOWN

QWERTY keyboard with ↩ key

8. Turn the **Rotary Knob** to the right to select the Latitude/Longitude field and press the **Rotary Knob**. Again the touchscreen keyboard appears. Insert the desired coordinates; when finished tap on **↩**, the keyboard disappears.

9. Turn the **Rotary Knob** to the right to select the Mode field and press the **Rotary Knob**.

! It is possible to use the **ShuttlePoint Knob** in place of the **Rotary Knob**. Make sure that the **SHUTTLEPOINT ENTER** item (in "Settings in General Setup Menu" paragraph, "Chart Plotter" section) is set to On, so pressing the **ShuttlePoint Knob** in the center is equal to confirm action.

10. You can choose among **SHOW** to show on the chart the name and icon of Mark, **ICON** to show on the chart only the icon of Mark or **HIDE** to hide on the Chart Page the created Mark. Tap on the desired mode to show the Mark.

11. Press the **CLEAR** key to save the created Mark.

12. Press the **CLEAR** key again and the new Mark appears on the Chart Page (see E).



! After entering in a Mark it is a good practice to backup the points to a SD CARD.

ROUTES

A Route can consist of Waypoints or Marks. The difference is when a Route is made using Waypoints and the Route is deleted the Waypoints are also deleted. However if a Route is made of Marks and the Route is deleted the Marks stay in memory.

See the example below that shows how the CPN Series Chart Plotter switches from one Waypoint to another.

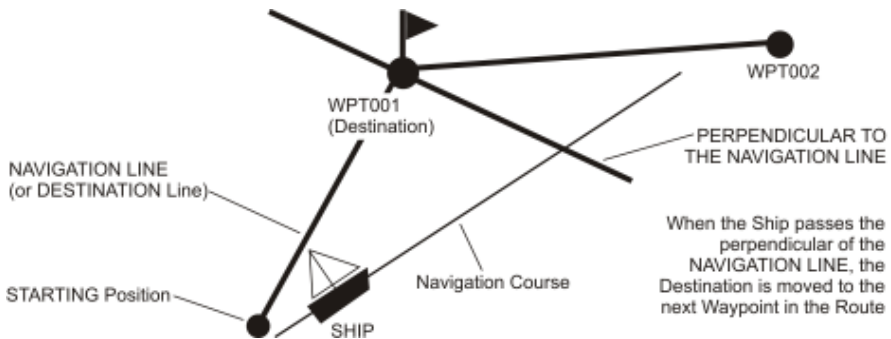

CREATING A ROUTE USING WAYPOINTS

1. On the Chart Page move the **+** ShuttlePoint Knob or touch the screen to the Lat/Lon of the starting Waypoint in the Route.
2. Press the **ROUTE** key, you will notice the Starting Waypoint **⊕** will be placed under the cursor.
3. Move the **+** ShuttlePoint Knob or touch the screen to the second Lat/Lon of the next leg in the Route.
4. Press the **ROUTE** key. You will notice another Waypoint is shown under the cursor and a line joins the Starting Waypoint to the Second Waypoint.
5. Repeat steps 3 and 4 until all Waypoints are entered into the Route.



- !** At this point the Route is saved as ROUTE01. If you would like to save the Route under a specific name follow the next steps.

CHANGING THE NAME OF A ROUTE

1. To name the Route move the **+** ShuttlePoint Knob or touch the screen on the Route (on Waypoint or on leg). For example if you touch on Waypoint this screen appears:

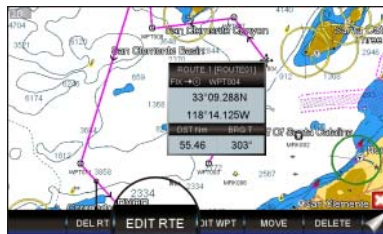

2. Tap on the **EDIT RTE** Soft Key. The Edit Route page appears:



EDIT ROUTE						
ROUTE: 1	NAME: ROUTE01	SPEED: 10.0 Kts	FUEL: 10.0 h			
WAYPOINT	LAT/LON	BEG	LDST	TDST	TIME	FUEL
	LONGITUDE	T	Time	Time		
WPT003	33°01.558N					
WPT004	117°42.256W	286°	27.72	27.72	002:46	27.7
WPT007	33°09.288N	220°	12.49	40.21	004:01	40.2
WPT008	118°14.125W	180°	19.61	59.72	005:58	59.7
WPT009	118°03.370W	253°	18.74	78.47	007:50	78.4
WPT010	32°41.451N	94°	53.23	131.7	013:10	131.
WPT011	117°34.045W	34°	19.62	151.3	015:07	151.
WPT012	32°38.423N					
	117°03.859W					

SELECT **NAME** COLOR INVERT CLEAR SPEED FUEL

- Tap on **NAME**. The touchscreen keyboard appears. Insert the desired Route name; when finished tap on , the keyboard disappears.
- Press the **CLEAR** key to show the Chart Page.

CREATING AN OLYMPIC ROUTE OR BOUNDARY

This feature allows the starting point in a Route to be saved as the final destination point.

- On the Chart Page move the  ShuttlePoint Knob or touch the screen to the Lat/Lon of the starting Waypoint in the Route.
- Press the **ROUTE** key, the starting Waypoint will be placed under the cursor.
- Move the  ShuttlePoint Knob or touch the screen to the second Lat/Lon of the next leg in the Route.
- Press the **ROUTE** key. Another Waypoint is shown under the cursor and a line joins the starting Waypoint to the second Waypoint.
- Repeat steps 3 and 4 until all Waypoints are entered into the Route (see A).



- Then move the  ShuttlePoint Knob or touch the screen to the last Waypoint.
- Tap on the **OLYMPIC** Soft Key. A line joins the starting Waypoint and the last Waypoint (see B and C).

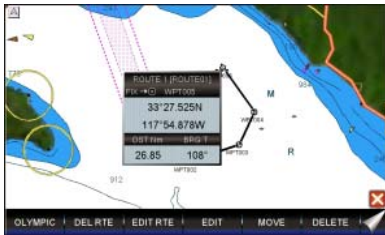

MAKING ADDITIONAL ROUTES

To create another Route the CPN Series Chart Plotter must be told that you want to create a second Route.

- Move the  ShuttlePoint Knob or touch the screen to the top of one of the Waypoints in a Route and tap on the **EDIT RTE** Soft Key. The Edit Route page will be shown.
- Tap on **SELECT**.
- Tap on an open Route number (example, Route 2).

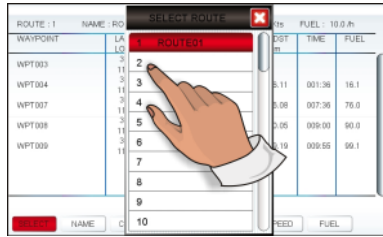

4. Press the **CLEAR** key.
5. To create the new Route, follow now the steps in the previous section "Creating a Route using Waypoints".

CREATING A ROUTE USING MARKS ON THE CHART PAGE

To create a Route containing Marks you first must create the Marks and show them on the Chart Page.

1. Move the **+** ShuttlePoint Knob over the top of a Mark that you wish to be the starting point in the Route and press the **ROUTE** key.



2. Next move the **+** ShuttlePoint Knob until the cursor is over the Mark that you want to be the next leg in the Route.
3. Press the **ROUTE** key. You will notice a bearing line joins the first and second Mark which means these Marks are selected into the Route.
4. Repeat steps 3 and 4 until all Marks are entered into the Route.

! You can touch the Mark on the display instead of using the **+** ShuttlePoint Knob.

INSERTING A WAYPOINT INTO A ROUTE

1. Touch or move the **+** ShuttlePoint Knob to the navigation line between two Waypoints and tap on the **INSERT** Soft Key (see A).



- The line between the two Waypoints is turned into a dotted line.
- Move the **+** ShuttlePoint Knob or touch the display in the desired location for the new Waypoint: the line will “rubber-band”, drawing a dotted line between the previous Waypoint and the cursor, and another dotted line between the cursor and the next Waypoint (see B). Once you have positioned the cursor at the location you want, tap on it or press the **●** Rotary Knob or the **+** ShuttlePoint Knob (if enabled) (see C).

! When in 3D mode, the 2D mode is automatically triggered. When a Waypoint is placed, the CPN Series Chart Plotter remains in 2D mode.

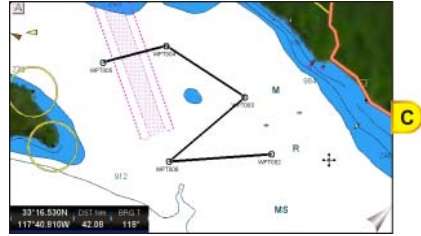
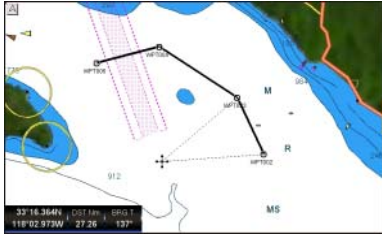

DELETING A ROUTE

To delete a Route follow the procedure below:

- Press the **MENU** key, tap on **User Points**.
- Tap on **ROUTE**.
- Tap on **DELETE**.
- A Warning message appears to confirm. Tap on **YES**. The Route has been deleted.

W An active Route (one that you are navigating to) cannot be deleted until you stop navigating to the Route.

OTHER SETTINGS IN ROUTE MENU

You will notice the **ROUTE** menu has other selections.

SELECT	Chooses an available Route to create or chooses a stored Route to show and follow on the Chart Page.
REVERSE	Reverses the Route, when chosen Starting point is at the end of the Route.
COLOR	Changes the color of the navigation lines between each leg in the Route.
EDIT ROUTE	Shows details of the Waypoints contained within the Route (Edit Route page). This menu also allows you to enter in your average speed and fuel consumption and calculate the approximate fuel used when following the Route.
SEND	Sends the stored points to a external device (PC) capable of listening to NMEA RTE sentence.
RECEIVE	Receive the points from an external device (PC) capable of sending NMEA RTE sentence.
THICKNESS	Selection that allows the Route line to be easily seen; default selection is Thin.

ROUTE CHECK

The Route Check function is used after you have created a Route to ensure you and your vessel will not have problems while navigating. This is done by the CPN Series Chart Plotter by reviewing the Route and looking for the following hazards that may effect safe navigation.

- Land Areas
- Shallow Water

- Intertidal Areas (*areas emerged at low tide*)
- Rocks
- Wrecks
- Obstructions
- Shoreline Constructions
- Fishing Facility
- Dredged Areas
- Diffusers (*submarine pipeline*)
- Mooring/Warping Facility
- Production Installation (*an installation for the exploitation of natural resources*)
- Pingos (*small conical hills having a large central core of ice formed from the encroachment of permafrost and the resulting hydrostatic pressure*)
- No Data Available (*no adequate data coverage*)

! This function checks the objects that belong to the standard charts. It does not check the objects belong to the VAD categories.

If any of these alarm conditions is detected, the function returns the list of dangerous objects (see B) and the relative dangerous Route leg, that is drawn with a different color (see A).

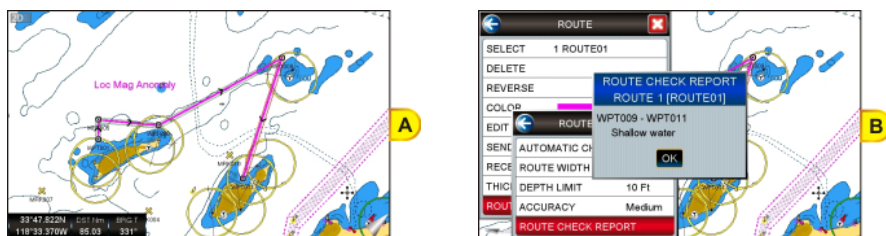

- Route legs which were classified as dangerous are displayed in RED. It means that there is at least one dangerous object in the vicinity of this leg and it has been found.
- Route legs which were classified as safe are displayed in GREEN. It means that the data was checked on detailed chart levels and no problems were found for all segments of the leg.
- Route legs for which there was not sufficient data to be checked are displayed in YELLOW. It means that no problems were found but the data was not sufficient or not available at all to classify such a leg as safe.

To activate the Route Check function:

1. Press the **MENU** key, tap on **User Points**.
2. Tap on **ROUTE**. The Route menu appears.
3. Tap on **ROUTE CHECK**. The Route Check menu appears. See the following table.

AUTOMATIC CHECK	Turns the Route Checking feature On or Off. Turn the Automatic Route Check on after you have created a new Route, or if you inserted a new Waypoint, deleted, moved or edited any Waypoint in a saved Route to confirm the Route can be safely navigated.
ROUTE WIDTH	Allows you to select the width from the left and right of the Route leg where the CPN Series Chart Plotter will check to confirm navigation threats. See the picture below. The default for this selection is 0.04NM.
DEPTH LIMIT	Allows you to select the water depth in the Route width area so the CPN Series Chart Plotter can check and confirm underwater threats. It checks if some objects with the depth attribute (like Shallow Water, Dredged Areas, Diffusers, Obstructions, Pingos, Production Installation and Wrecks) are above this depth level. Only if the depth attribute is above the depth limit are they found and considered as dangerous. See the picture below. The default setting is 10FT.

ACCURACY

Defines a segment length into which a leg of the Route is divided in order to execute the search for dangerous objects with better accuracy. When accuracy is maximal, a segment length is the shortest. When accuracy is minimal, a segment length is the longest. Selects among Minimum, Low, Medium, High and Maximum. See the picture below. The default setting is Medium.

ROUTE CHECK REPORT Shows the list of the dangerous objects found on the charts crossed by the Route.

ⓘ Although the functionality is called Route Check, it can also be activated when the navigation is set to a single point (like DSC, MOB, Mark). In the case of checking a single point towards which the navigation is started, the leg for which the Route Check is executed is defined by the current position (the leg's starting point) and the destination point (the leg's ending point).

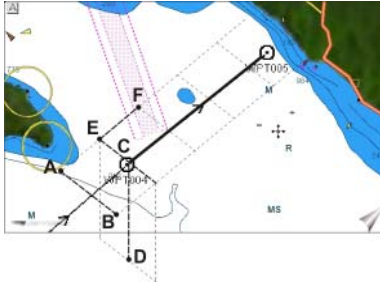

A-B = Width
C-D = Depth
E-F = Accuracy

EASY ROUTING (ER)

ⓘ ONLY AVAILABLE WITH OPTIONAL C-MAP BY JEPPESEN CARTOGRAPHY

Easy Routing calculates the shortest safe Route between two chosen points (sometimes the calculation of complex Routes can be time consuming).

With Easy Routing giving a Start Point and End Point the CPN Series Chart Plotter will automatically propose you a safe a shortest Route connecting the two points. The calculation of the Route depends of a few parameters (boat length, wide and keel, mast height and precaution to sail close to the coastline) which define your boat and the precautions you want to keep for navigating. While calculating the Route the Easy Routing will avoid obstacles (likes Nav-Aids, Rocks, Obstruction, Shallow waters, Bridges) and draw the final and proposed Route with different colors highlighting the possible hazards:

- A RED color usually indicates a condition of unsafe navigation like in case a Route is crossing a very shallow water.
- A YELLOW color shows legs where maximum attention should be taken: for example a bridge is present along the leg but its vertical clearance it not know from data.
- In case of a GREEN color the leg is safe: there are no known hazards along the leg considering the parameters used.
- In certain case, due to the complexity of the earth at the Start/End point the Easy Routing will shift the point and place it in a safer condition. This leg is indicated with a GRAY color.

Please pay attention that Easy Routing, due to data in input, could not avoid on crossing hazard areas to reach the final destination producing in this case RED and YELLOW legs. In this case the Captain should review the proposed Route and in case modified it accordingly.

ⓘ The accuracy of Easy Routing is limited by availability of electronic charts loaded on your navigation system and the accuracy of original source material used in producing such charts. Always remember that you should navigate with the most detailed and up-to-date chart data available from Jeppesen, and that

new information from National Hydrographic Offices may render your charts obsolete at any time. Easy Routing will now calculate and save the best suggested Route between your Start and End points (over a maximum total distance of 100Nm), based on parameters set by you.

Easy Routing is only an aid to navigation and must be used in conjunction with conventional navigation practices.

As the navigator of your vessel, you are responsible for reviewing the suggested Route against the official publications and situational awareness. You must edit and/or approve the suggested Route before using it for navigation purposes.

To activate this function:

1. Press the **MENU** key, tap on **User Points**.
2. Tap on **ER**. The Easy Routing menu window appears on the screen:



It allows setting of the parameters for the function. See the table below.

SAFE DEPTH	Takes in consideration boat's draught while making a Route. The default setting is 6.5 Ft (2 Mt).
SAFE HEIGHT	Takes in consideration boat's height while making a Route. The default setting is 39 Ft (12 Mt).
SAFE CORRIDOR	Takes in consideration boat's width while making a Route. The default setting is 0.002 NM (4 Ft).
SAFE MARGIN	This is an On/Off setting which enables to calculate a Route at a distance greater than 300 meters from the coast. The default setting is On.
RESPECT DRAUGHT	When On, discards areas with a depth lower than the Safe Depth. The default setting is Off.
TIMEOUT	Sets the timeout after which the function exits automatically (if Route calculation is not yet completed). The default setting is 5 Minutes.

3. When all parameters are set, tap on **START EASY ROUTING**. A Warning window appears (see A). Move the **+** ShuttlePoint Knob up/down or turn the **●** Rotary Knob to left/right or touch the scroll bar up/down to go from one page to another.
4. Tap on **OK** to start the Easy Routing steps for defining the Start (start point for the path) and End (destination point for the path) points (otherwise tap on **EXIT** to abort). The Select Route window appears, to select a Route in which the calculated ER Route will be saved (see B).

! Start and End points can be defined not only under the current cursor position but also on a chosen User Point or geographical position or Port Service/POI.

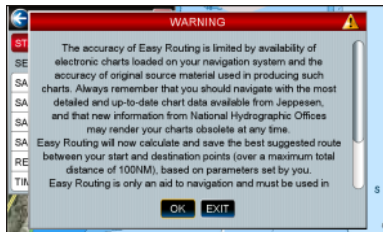

5. Select the desired row by turning the **Rotary Knob** to left/right or touching the scroll bar up/down and tap on it (otherwise tap on **X** to close the window and abort the Easy Routing function). The Chart Page appears.
6. Anywhere on the Chart Page move the **ShuttlePoint Knob** or tap on the display to select the starting point, (see C) and then tap on the **ER START** Soft Key, to define the Start point. A new window appears (see D).

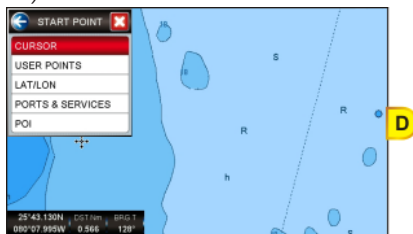
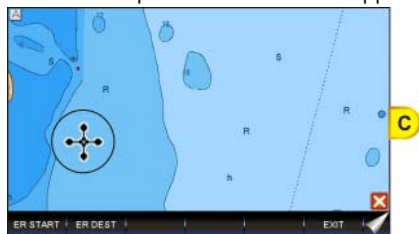

7. Tap on **CURSOR**. The Start point is set on the cursor position (see E).
8. Then move the **ShuttlePoint Knob** or tap on the display to select the destination point and then tap on the **ER DEST** Soft Key, to define the End point. A new window appears.
9. Tap on **CURSOR**. The End point is set on the cursor position (see F).

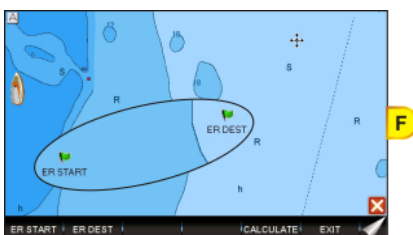

10. Tap on the **CALCULATE** Soft key, to start the Easy Routing calculation.
11. The message “Calculating the Route ...” appears. When calculation is completed, the report on the new Route appears (see G).
12. Tap on **DETAILS** to see more information. Otherwise tap on **OK**. The path between the two points appears on the screen (see H).



Warning Messages

The following are the messages of warning which could appear during Easy Routing operations.

- **Distance between Start and Destination points exceeded allowed limit of 100Nm. Calculation cannot be started.**
Displayed when the Start or End points are too distant.
- **Start and Destination points placed at the same position. Route has not been calculated.**
Displayed when the Start or End points have been set at the same position.
- **Timeout has been exceeded. Route has not been calculated.**
Displayed when the Route generation operation took more time than was allowed.
- **Latitude of the defined points is greater than 80 degrees. Route has not been calculated.**
Displayed when the Start and/or End points Latitude is over 80 degrees N/S.
- **Start or Destination point of Route cannot be moved to a navigable position on water. Route has not been calculated.**
Displayed when one or both the ends of the Route cannot be moved on water.
- **Route calculation has been halted.**
Displayed when the Route generation was aborted by a user.
- **Route has not been calculated.**
Displayed in all other error situations.
- **Route is too complex, calculation could not complete.**
Displayed when the Route to be calculated is too complex and there are memory problems to calculate it.
- **Destination present on a Route. Navigation will be stopped before Easy Routing begins.**
Displayed when the Destination is present on a Route.
- **Selected Route will be overwritten with results of Easy Routing. Do you want to proceed?**
Displayed when the Route can be overwritten,
- **No charts with Easy Routing data found. Calculation cannot be started.**
Displayed when there is no Easy Routing data on the charts.

The following touchscreen keys might appear to handling these warning situations:

- tap on **NEW** to define the Start and End points again
- tap on **CONTINUE** to start the Easy Route steps in which you can define the Start and End points
- tap on **EXIT** to exit from Easy Routing functionality

GOTO KEY OPERATION

The CPN Series Chart Plotter can easily be set to start navigating to the Cursor on the Chart Page, a saved Mark or a Route that was created.

GOTO CURSOR

1. Tap or move the  ShuttlePoint Knob to the exact position on the chart you want to

navigate to.

- Press the **GOTO** key and a GOTO popup window will be shown (see A).

ⓘ If an Easy Routing has been creating, there is **ER** item too.

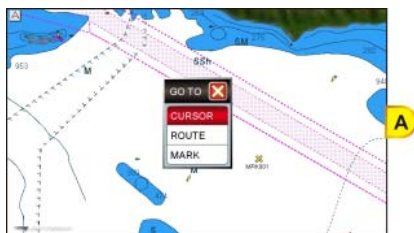

- Tap on **CURSOR**.
- The CPN Series Chart Plotter is now navigating from your current position to the location selected at step 1. A bearing line between the vessels location and the destination point is shown. A popup window shows the Distance (DST) and Bearing (BRG) from the vessels location to the destination point (see B and C).



- The CPN Series Chart Plotter is in Cursor Mode, to switch to Home Mode press the **CLEAR** key so the vessel will stay in the center of the page.

ⓘ It will also automatically switch to Home Mode after the timeout set in Home Mode Revert.

- Soft Keys are also shown that allow you to quickly switch to the Highway Page or to Stop navigation.
- To Stop Navigation, press the **GOTO** key and a Warning Window is shown. Tap on **STOP**.



GOTO A ROUTE

After you have created a few Routes, you can choose one of them to GOTO.

Using **GOTO** to select Route

- Tap on an open position (no buoy, warning etc. under the cursor) on the Chart Page.
- Press the **GOTO** key to show the GOTO popup window (see A).

3. Tap on **ROUTE**.
4. The SELECT ROUTE window will be shown (see B).



5. Select the desired Route by moving the **+** ShuttlePoint Knob up/down or turning the **●** Rotary Knob to left/right or touching the scroll bar up/down and tap on it.

! If an empty row has been selected, a Warning window appears, tap on **OK**.

6. On the Chart Page, a circle with a Flag is shown on the first leg of the Route you chose and a navigation line is shown, indicating the CPN Series Chart Plotter is navigating to the first Waypoint in the Route (see C).

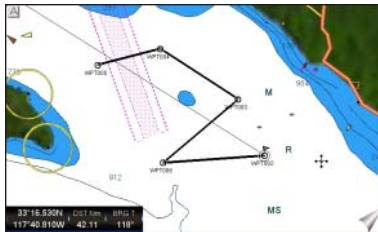

Using the **+** ShuttlePoint Knob

1. On the Chart Page move the **+** ShuttlePoint Knob until the cursor reaches the starting point (or any Waypoint in the Route) of the Route.
2. Press the **GOTO** key to start following the Route.
3. Press the **CLEAR** key twice to revert to Home mode.

GOTO MARK

1. Move the **+** ShuttlePoint Knob to an open position no buoy, waning etc. under the cursor on the Chart Page.
2. Press the **GOTO** key to show the GOTO popup window.
3. Tap on **MARK** to show the **MARKS/WAYPOINTS** List.
4. Tap on the desired Mark or Waypoint and press the **GOTO** key.
5. You will notice a circle is drawn around the Icon Symbol. This means the CPN Series Chart Plotter is now navigating to the point.
6. Press the **CLEAR** key to close the Marks/Waypoints page.

! The CPN Series Chart Plotters can start navigating to the cursor location, a saved Mark or any Waypoint in a Route simply by touching the display or moving the cursor using the **+** ShuttlePoint Knob or tapping on the display to a location or on the top of a Mark or Waypoint on the chart and pressing the **GOTO** key.

MAN OVER BOARD (MOB) FUNCTION

During navigation, the “MOB” feature provides a one-touch method of storing a location, such as a point where a crew member fell overboard. In this mode, the CPN Series Chart Plotter places a MOB point on the Chart Page and all the navigation data shown is related to navigating back to this point, allowing you to retrace your path to the MOB point efficiently.

PLACING A MOB POINT

1. On the Chart Page, press the **MOB** key to start navigating back to the point. A Warning window appears to advise that the MOB function has been activated, tap on **OK**.
2. Press the **CLEAR** key. You will notice a MOB Mark will be on the Chart Page and all navigation is referring back to this point (see A).



3. To stop navigating to the MOB point, press the **GOTO** key and tap on **STOP** (see B).

DELETING A MOB POINT

1. After stopping navigating to the MOB point, tap on the top of the MOB icon. The Soft Keys appear (see A).



2. Tap on the **DELETE** Soft Key. A popup window will be shown to confirm deleting the MOB point (see B).
3. Tap on **YES**.

⚠ Pressing the **MOB** key again allows deleting a previous MOB. A Warning window appears to advise that MOB is already present, tap on **DELETE**. This allows to stop navigating to the MOB point and also deleting it.

TRACKS

The CPN Series Chart Plotter has the capability to store 20 individual tracks and record up to 10,000 Track Points.

ⓘ Please note the Track point memory is 10,000 points. This means for a long journey you may have to adjust the time or distance to be able to track your journey. It should be noted when the 10,000 Track points are used up, the first Track point layed down will be deleted when a new point is placed on the chart.

Before using the Track function you will need to setup the Track function that suits your boat. The Track function records your tracks your vessels location as it moves through the water. The Track function can be setup to lay down a Track for a predetermined time or distance interval. If you have a fast moving boat you may want to setup the CPN Series Chart Plotter to record a Track point every 0.5NM or if you have a Sail boat you may want to setup to lay down a Track point once ever 1 minute.

To set the time or distance interval you want follow the procedure:

1. Press the **MENU** key, tap on **User Points**.
2. Tap on **TRACK**. The Track menu appears.



3. Tapping on **STEP UNIT** selects between **Dist** or **Time**.
4. Tap on **DISTANCE** or **TIME** step interval.
5. Tap on the desired step value and tap on it.
6. Press the **CLEAR** key or tap on **X** in the Track window to exit the menu.



When using the Tracking feature you will notice every time a Track Point is layed down on the Chart Page a small filled in circle is shown on the Track line.







If you move the cursor over the top of the circle a popup window will be shown with the Time, Water Temperature, Speed and Course Over Ground (COG). This is very useful if you are fishing and want to review the conditions where the fish were being caught.

SAVING AND STARTING A NEW TRACK

A Track can be saved and retained in memory when the power is turned off. To start a new Track:

1. Press the  key, tap on **User Points**.
2. Tap on **TRACK**.
3. Tap on **ACTIVE TRACK**.
4. Enter the next Track number using the touchscreen keyboard. Tap on  to select the new Track.
5. Tap on **TRACKING** to start laying down Track points.
6. Tap on  to exit the menu to the Chart Page.

DELETING A TRACK

1. Press the  key, tap on **User Points**.
2. Tap on **TRACK**.
3. Tap on **ACTIVE TRACK**.
4. Enter the Track number using the touchscreen keyboard. Tap on .
4. Tap on **DELETE**.
5. A warning window will be shown to confirm if you want to reset the Track. Tap on . The Track is now deleted.
6. Tap on  to exit the menu to the Chart Page.

OTHER SETTINGS IN THE TRACK MENU

You will notice the Track Menu has other selections:

TRACKING	Allows turning On or Off (default) the tracking function.
ACTIVE TRACK	Allows saving a Track to one of the 5 Tracks available. Track 1 is the default.
VISIBLE	Shows (On) or hides (default, Off) a Track selected in ACTIVE TRACK menu.
LINE COLOR	Selects the color of the Track line.
DELETE	Deletes a Track selected in the ACTIVE TRACK menu.
STEP UNIT	Allowable selection are Distance (default) or Time .
DISTANCE	User adjustable Distance interval of when Track point is laid down on the Chart Page. 0.1 Nm is the default setting.
TIME	User adjustable Time interval of when Track point is laid down on the Chart Page. 5 min is the default setting.

TRIP LOG

TRIP LOG SELECTION IN DATA WINDOW

On the Chart, Navigation, Highway and NMEA Data pages the windows may be customized to show Trip Log information.

1. Select one of the pages listed above, press and hold the  key. You will notice one

of the data boxes will be highlighted in yellow.

2. Tap on the yellow highlighted window to show a selection popup window.
3. Tap on **TLOG**.
4. A window will be shown with **Nm** (Nautical Mile), **Sm** (Statute Mile), **Km** (Kilometer), **Nm+Ft**, **Nm+Mt** and **RESET**. Tap on the desired units of measure.

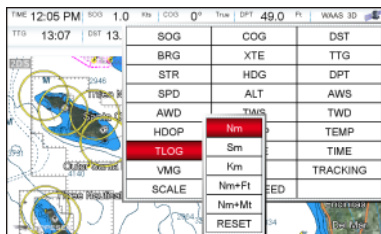

5. Press the **CLEAR** key one time so yellow highlight is removed from the data window.

SETUP / RESET

When Trip Log is selected in one of the data windows and you want to reset the log:

1. Press and hold the **MENU** key until a field is highlighted (it will be shown in a yellow frame).
2. Tap on **TLOG**.
3. A window will be shown. Tap on **TLOG**.
4. Another window will be shown. Tap on **RESET**.
5. A Warning window will be shown to confirm if you want to reset the Trip Log. Tap on **YES**. The Trip Log is now reset.



6. Press the **CLEAR** key three times to store and exit the editing mode.

USER SD CARD

An optional SD CARD can be used to backup Marks, Routes, and Tracks stored in your CPN Series Chart Plotter's memory. In this case the SD CARD is similar to a backup disk used with a PC. The SD CARD is useful to backup User Points when the RAM has to be cleared to resolve an issue or load new software, or if you would like to transfer Waypoint, Track and Route information from one STANDARD HORIZON CPN Series Chart Plotter to

another.

The information shown below will assist you to transfer the User Points, Routes and Track history to the SD CARD.

- 1 Time of file creation
- 2 Date of file creation
- 3 Type of data contained in the file (Mark file, Waypoint file...)
- 4 File name
- 5 Number of Selected file
- 6 Information on stored User Points on Internal Memory

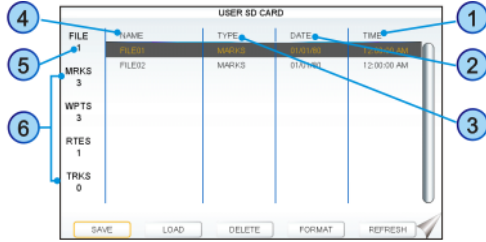

FORMATTING THE SD CARD

! If there is a C-MAP 4D CARD inserted into the slot, before formatting procedure, please safely remove it using the following steps:

1. Press the **MENU** key, tap on **Setup Menu**.
2. Tap on the right arrow next to ADVANCED Desktop icon two times to display **ABOUT** and tap on it.
3. Tap anywhere in the About Page to display Soft Keys.
4. Tap on the **REMOVE SD** Soft Key. A message is shown for informing you that it is possible to remove the cartridge from the slot.
5. Tap on **CONFIRM** in the popup window, then on **CLOSE** on the next window.
6. Open the door, gently remove the SD CARD from the slot.
7. Press the **CLEAR** key repeatedly to exit.

1. Open the SD CARD door and insert a optional SD CARD.
2. Press the **MENU** key, tap on **User Points**.
3. Tap on the right arrow next to DSC DIR Desktop icon two times to display USER CARD.
4. Tap on **USER CARD**. The USER SD CARD page appears.
5. Tap on the **FORMAT** Soft Key.
6. A Warning window appears to confirm you want to format the SD CARD.
7. Tap on **YES** to confirm (or press the **CLEAR** key). The format of SD CARD prepares the SD CARD to receive and store information.
8. Tap on **OK** to confirm.

! Formatting permanently erases all files previously saved on the SD CARD.

TRANSFERRING FILES TO THE SD CARD

1. Insert the SD CARD into the slot.
2. Press the **MENU** key, tap on **User Points**.
3. Tap on the right arrow next to DSC DIR Desktop icon two times to display USER CARD.
4. Tap on **USER CARD**. The USER SD CARD page appears.
5. Tap on the **SAVE** Soft Key.

6. A popup **SAVE FILE** window appears. In this window you can change the name and the file type tapping on it.
7. To save the file, tap on **SAVE** in window. The Information window is momentarily be shown *SAVING* then shows *SAVING...OK*.
8. Tap on **OK** to confirm.

LOADING A FILE FROM THE SD CARD

If you have a problem and accidentally loose the User Points in the CPN Series Chart Plotter, with a SD CARD it is possible to load the data back into the CPN Series Chart Plotter using the following procedure:

1. Press the **MENU** key, tap on **User Points**.
2. Tap on the right arrow next to DSC DIR Desktop icon two times to display USER CARD.
3. Tap on **USER CARD**. The USER SD CARD page appears.
4. Select the saved file from the USER SD CARD list by tapping on it.
5. Tap on the **LOAD** Soft Key. The Information window *LOADING...OK* appears when loading is complete.
6. Tap on **OK** to confirm.

DELETING A FILE FROM THE SD CARD

You may want to delete a saved file on the SD CARD inserted in the slot.

1. Press the **MENU** key, tap on **User Points**.
2. Tap on the right arrow next to DSC DIR Desktop icon two times to display USER CARD.
3. Tap on **USER CARD**. The USER SD CARD page appears.
4. Select the saved file from the USER SD CARD list by tapping on it.
5. Tap on the **DELETE** Soft Key. The Warning window appears to confirm you want to delete the file.
6. Tap on **YES** to confirm.

REFRESHING THE SD CARD

You may want to change the SD CARD inserted in the slot with a new one.

1. Press the **MENU** key, tap on **User Points**.
2. Tap on the right arrow next to DSC DIR Desktop icon two times to display USER CARD.
3. Tap on **USER CARD**. The USER SD CARD page appears.
4. Open the door, remove the SD CARD from the slot and insert another SD CARD into the same slot.
5. Tap on the **REFRESH** Soft Key. This "new" SD CARD is now ready to receive and store information.

MAIN MENU

The Main Menu allows quick and easy Page Selection and setup of CPN Series Chart Plotter. Press the  key from any page to show the Main Menu. This display consists of two parts:

- ① Page Icons
- ① Desktop Icons



- the page selection area with the **Page Icons** ①. There are 9 Page Icons specified: Chart, Navigation, NMEA, Fish Finder (only active when FF connected), Tide, User Points, Video Input (only active when Video Camera connected), Setup Menu and AIS.
- the desktop area with the **Desktop Icons** ②. Each Page Icon has a defined related set of Desktop Icons.

Only 8 Page Icons can be displayed on the screen at one time. To scroll to the next column of Page Icons, the right hand arrow (or top right hand arrow if two are displayed) can be tapped. It will be active as long as there are more Page Icons to be displayed. In order to display the previous set of Page Icons the top left arrow has to be tapped. It is active as long as the initial set of icons is displayed.



The same scrolling mechanism is applied to the Desktop area.

The selected Page Icon and Desktop Icon are graphically marked.

- ⓘ Refer to the previous image you will notice right arrows which when pressed will show additional Page Icons or Desktop Icons depending on the arrow pressed. To display a previous set of Page or Desktop Icons tap on the left arrow.

SELECTING A PAGE OR MENU

1. Press the  key to show the Main Menu.
2. Tap on the desired Page Icon. The related set of Desktop Icons is displayed in the Desktop area on the bottom of the page.

- ⓘ  ShuttlePoint Knob
Page icons may be selected by moving the  ShuttlePoint Knob up/down or left/right.

3. Tap on the desired Desktop Icon to change the display.

- ⓘ  Rotary Knob
Desktop Icons may be chosen and selected by rotating the  Rotary Knob and pressing it in.

For example, to select the Dual Chart page:

1. Press the **MENU** key.
2. Tap on **Chart** Page Icon. In the bottom of the page the available Desktop Icons appear (see A).
3. Tap on **DUAL** Desktop Icon (see B). The Dual Chart page appears (see C).



CUSTOMIZING A PAGE ICON

1. Tap on the icon to be changed.
2. Press and hold the **MENU** key to show the Page Icons Selection menu:



3. Tap on a page name to switch the location of the two icons.

CHART PAGE

The Chart Page is the main page of the CPN Series Chart Plotter. From this page the user can zoom in/out, pan around the chart, show information about cartographic objects, see the exact vessel position with the COG and SOG, place points, GOTO a destination point, show Track history etc.

1. Press the **MENU** key, tap on **Chart**. In the bottom of the page the available icons appear: **SINGLE** opens the Chart Page, **DUAL** opens the Dual Chart Page, **& HIGHWAY** opens the Chart/Highway Page and **FIND** opens the Find Services & More menu.

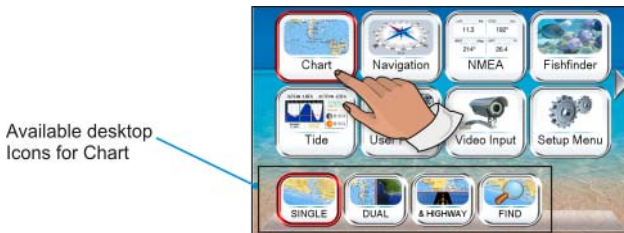

① For **& HIGHWAY** please see “Chart/Highway” in the “Navigation Pages” section, and for **FIND** see “Using Find Services” section.

Single

To show a single chart, follow the procedure below:

1. Press the **MENU** key, tap on **Chart**.
2. Tap on **SINGLE**.



① Time
② Speed Over Ground
③ Course Over Ground
④ Depth
⑤ Fix status
⑥ Time To Go (If plotter is not navigating to a point TTG will show --:--)
⑦ Distance from Fix to Destination (If plotter is not navigating to a point DST will show ---)
⑧ Bearing from Fix to Destination (If plotter is not navigating to a point BRG will show ---°)
⑨ Cursor Coordinates
⑩ Distance/Bearings from Fix to Cursor
⑪ Chart Scale
⑫ Trip Log

Dual

Selecting this page will show two chart windows, both of which the chart may be independently setup:

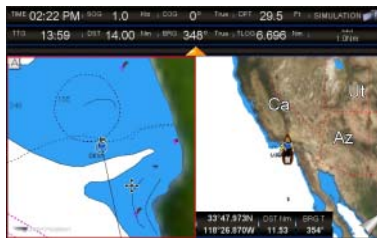

1. Press the **MENU** key, tap on **Chart**.
2. Tap on **DUAL**.



When Dual Chart is selected, you will notice one of the chart windows will have a red boarder around it. This red boarder indicates which chart window the CPN Series Chart Plotter has the focus on, meaning if the **+** ShuttlePoint Knob is moved the cursor on chart window will move. The focus may be changed to the other chart window by tapping on the desired screen: the red boarder around the window is moved from active window to the other.

Data Window Selections

The CPN Series Chart Plotter windows may be changed on CHART and DUAL CHART pages by the following procedure.

1. To change, press the  key, tap on **Setup Menu**.
2. Tap on **GENERAL**.
3. Tap on **CHART PAGE WINDOW**.
4. Tap on the desired selection. The default is the 2 Lines Small window.
5. Tap on  to exit to the Chart Page.

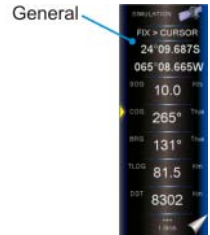

Customizing Data Windows

The data fields contained on the General, 1 Line Small/Large and 2 Lines Small data windows can be changed to the following selections:

- SOG = Speed Over Ground
- COG = Course Over Ground
- DST = Distance to Destination
- BRG = Bearing to Destination¹
- XTE = Cross Track Error
- TTG = Time To Go
- STR = Steering
- HDG = Heading from Electronic Compass
- DTP = Depth
- SPD = Speed
- ALT = Altitude
- AWS = Apparent Wind Speed
- AWD = Apparent Wind Direction
- TWS = True Wind Speed
- TWD = True Wind Direction
- HDOP = Horizontal Dilution of Precision
- VDOP = Vertical Dilution of Precision
- TEMP = Water Temperature
- TLOG = Trip Log
- DATE = Current Date
- TIME = Current Time
- VMG = Velocity Made Good
- ETA = Estimated Time of Arrival
- TRACKING = Tracking
- SCALE = Chart Scale²
- MAX SPEED = Max Speed
- POSITION³

 ¹ When the GENERAL window is selected and the CPN Series Chart Plotter is in Home Mode, the BRG will show ---, unless the CPN Series Chart Plotter is navigating to a point. When in Cursor Mode, the BRG shows the Bearing from the ship's position to the cursor location.

!² Chart Scale is available only for chart pages (1 Line Small, 2 Lines Small, 1 Line Large) and is always displayed in the General Chart window (it is not customizable there).

!³ Available only on the Highway Page/Chart Page 1 Line Large.

To select the desired field, follow the procedure:

1. Press and hold the **MENU** key until a field is highlighted (it will be shown in a yellow frame, see A).
2. Tap on the desired data field (the yellow frame is moved to the desired data field). The popup window will be shown (see B).

! For Data Boxes which can be displayed in different units, units can be also selected.

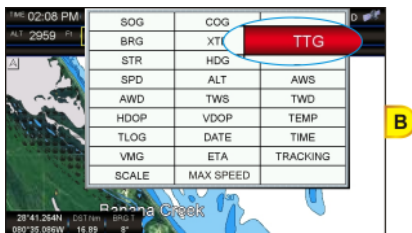

3. Tap on the desired setting (see C).



4. Press the **CLEAR** key to store and exit the editing mode.



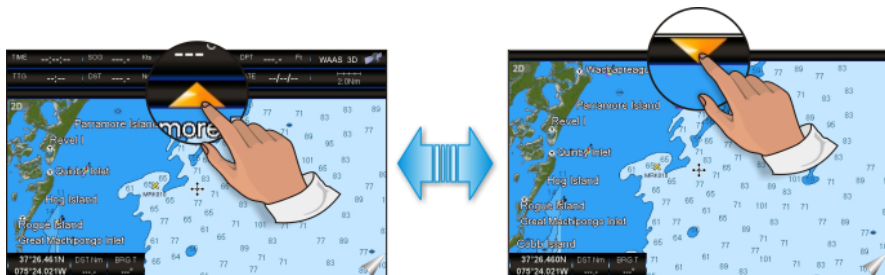

! Data window on the Compass, Highway, GPS Status, NMEA Display and Fish Finder pages may be customized in the above manner.

Collapsing Data Windows

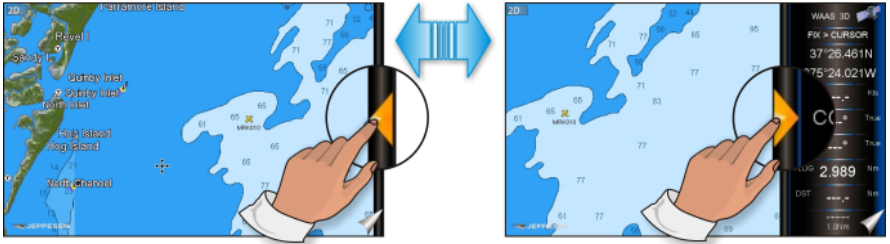
A data window may be collapsed or shown to show more or less chart area. To collapse or expand a window, tap on the arrow key as show on the image below.





- If the Data Window is enlarged, touching the icon  collapses the 1 Line Large / 1 Line Small / 2 Lines Small Data Window and touching the icon  collapses the General Data Window.
- If the Data Window is collapsed, touching  expands the Data Window back to 1 Line Large / 1 Line Small / 2 Lines Small or touching  expands the General.

Additional Functions on Chart Page: Information on Objects

When on the Chart Page you will notice icons of Buoys, Towers, Lights, Wrecks, Tide Stations, Port Icons, and so on. If the cursor is moved over the top of these icons a popup window will be shown containing information about the icon (this is possible only if the Auto Info function is enabled).

The CPN Series Chart Plotter allows you to see information **On All** cartographic objects shown on the screen (see A), or only **On Points** (see B) or to turn this function Off, in this case no popup window is shown when the cursor is placed on a cartographic object (see C). The default setting is On Points.

AUTO INFO On All

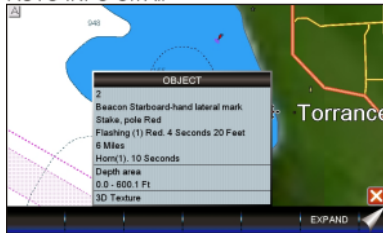

AUTO INFO On Points

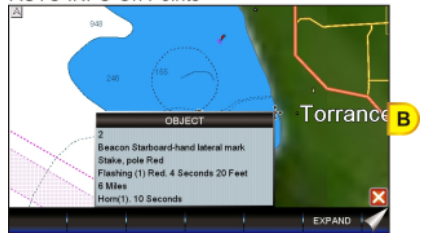

AUTO INFO Off



To select the information displayed on Objects follow the procedure:

1. Press the **MENU** key, tap on **Setup Menu**.
2. Tap on **GENERAL**.
3. Turn the **Rotary Knob** to select **AUTO INFO** and tap on it.
4. Tap on **Off**, **On Points** or **On All**.
5. When the item you want has been selected, press the **CLEAR** key to exit the menu.

Display Mode

Selects from a pre-defined table what cartographic objects are displayed and which display options are set. Pre-programmed settings are user selectable from Full, Medium, Low, Radar (reduces the information on the display to simulate items that would be shown on a RADAR display. Please note this function is not actually showing RADAR information it is only showing what typically would be shown by a separate dedicated RADAR display), Tides, Custom (default mode). To change to one of the pre-programmed settings

1. Press the **MENU** key, tap on **Setup Menu**.
2. Tap on **CHART**. The Chart Configurations menu appears.
3. Tap on **DISPLAY MODE**.

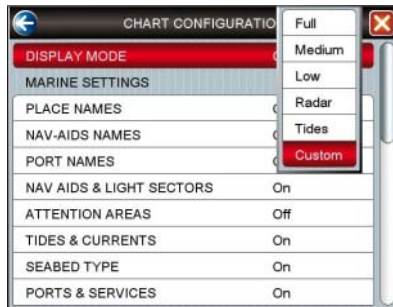

4. Tap on the desired preset among **Full**, **Medium**, **Low**, **Radar**, **Tides** and **Custom**.
5. Tap on **X** to exit to the Chart Page.

The following table shows the selections for each mode:

Setting	Full	Medium	Low	Radar	Tides	Custom (Default values)
Place Names	On	On	On	On	On	On
Nav-Aids Names	On	Off	Off	Off	Off	Off
Port Names	On	Off	Off	Off	Off	Off
Nav Aids & Light Sectors	On	No Sectors	No Sectors	No Sectors	Off	On
Attention Areas	On	On	Off	Off	Off	On
Tides & Currents	On	Off	Off	Off	On	On
Seabed Type	On	Off	Off	Off	Off	On
Ports & Services	On	On	Off	On	Off	On
Tracks & Routes	On	Off	Off	Off	Off	On
Depth Shading Mode	Dynamic	Dynamic	Dynamic	Dynamic	Dynamic	Dynamic
Safe Depth	15FT	15FT	15FT	15FT	15FT	15FT
Depth Range Min	0FT	0FT	0FT	0FT	0FT	0 Ft
Depth Range Max	32804FT	32804FT	32804FT	32804FT	32804FT	32804FT
Lat/Lon Grid	On	Off	Off	Off	Off	Off
Boundaries Mode	Auto	Auto	Auto	Auto	Auto	Auto
Chart Boundaries	On	Off	Off	Off	Off	Off
VAD Boundaries	On	Off	Off	Off	On	On
Chart Lock	On	On	On	On	On	On
Underwater Ob. Limit	1000FT	32FT	32FT	32FT	32FT	1000FT

Rocks	Icon + Depth	Icon	Icon	Icon	Icon	Icon
Obstructions	Icon + Depth	Icon	Icon	Icon	Icon	Icon
Diffusers	Icon + Depth	Icon	Icon	Icon	Icon	Icon
Wrecks	Icon + Depth	Icon	Icon	Icon	Icon	Icon

Marine Settings

To control the display on the chart of the marine features.

Place Names	: Turns the local area names On or Off .
Nav-Aids Names	: Turns the Nav Aids names On or Off .
Port Names	: Turns the Port names On or Off .
Nav Aids & Light Sectors:	Turns the presentation of Lights, Signals, Buoys and Beacons On (Nav Aids & Light Sectors are shown), Off (Nav Aids & Light Sectors are not shown) or No Sectors (Nav Aids are shown, Light Sectors are hidden).
Attention Areas	: Turns the Attention Areas (areas in which special attention by the mariner is required because of natural or man-made hazards sailing regulations and restrictions) On or Off .
Tides & Currents	: Turns the Tides and Currents On or Off . When data/time is available, Tidal stream arrows are shown on the charts, indicating the direction and strength of the Tide. If no data/time is available from the GPS or the CPN Series Chart Plotter is not in Simulation mode, the icon on the chart is generic one. The color of the arrow denotes the strength of the current as follows:

0 to 0.1 kn -	Yellow
0.2 to 1.0 kn -	Yellow
1.1 to 2.0 kn -	Orange
2.1 to 3.0 kn -	Orange
3.1 to 9.9 kn -	Red

When the CPN Series Chart Plotter receives a valid position fix, the Tide icons are shown on the charts on the basis of the current date and time: the screen displays and changes arrows as date/time changes.

Seabed Type	: Turns the Seabed Type On or Off .
Ports & Services	: Turns the Ports and Service icons On or Off . Areas along the shore with facilities for mooring, downloading and uploading of ships, generally sheltered from waves and winds. Port installations are piers, wharves, pontoons, dry docks, cranes....
Tracks & Routes	: Turns the Tracks and Routes objects (recommended and established routes for ships at sea, including traffic separation schemes, deep water routes) On or Off .

Depth Settings

Controls the depth information on the Chart page.

Depth Shading Mode	: Selects among three different Depth Shading Modes: Safe , Dynamic and Dynamic Inverted . Each shading method presents the depth area, and the color used to display it, according a different rule. In Dynamic and Dynamic Inverted modes, it's possible to highlight particular depth area selecting a depth interval; you can choose a particular depth range and each depth area which overlaps these values will be highlighted with a defined color. Dynamic : When shading mode is set to Dynamic, the depth areas are drawn using a color defined dynamically according the deepness of the other areas that have to be displayed. It's possible to summarize the behavior of this mode in these few steps: first of all, any deepness will be collected in a ordered list, then 32 different blue colors from dark blue to white are assigned to these values. White is used to draw the highest depth area. Dynamic Inverted : Dynamic Inverted mode is similar to Dynamic mode, the only difference is that dark blue will be used for the highest depth area and white for the lowest depth area. Safe : Safe mode permits to identify the areas with a deepness above a value specified by user (see Safe Depth option). This shading mode is very important to identify the map region where the deepness is greater than a specified value and for this reason the shading can be considered safe.
---------------------------	---

Safe Depth : In Safe mode, it's necessary to set the value for the Safe Depth to identify safe and unsafe area. If this value isn't set, all depth areas appear with the same color. Sets the value in the range 0 - 1000Ft. The default setting is 15Ft.

Depth Range Min : Sets the minimum depth limit for Spot Soundings and Depth Contours.

Depth Range Max : Sets the maximum depth limit for Spot Soundings and Depth Contours.

0-1000 Ft



50-100 Ft

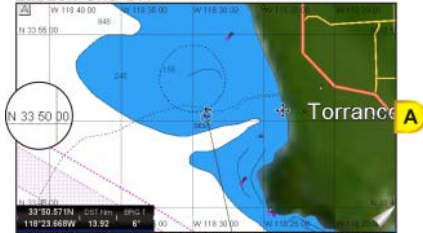

Chart Settings

Settings that control how the chart features will be shown on the Chart Page of the CPN Series Chart Plotter.

Lat/Lon Grid : Turns the Latitude and Longitude grid lines **On** (see A) or **Off** (see B) on the Chart Page.

Lat/Lon Grid ON



Lat/Lon Grid OFF



Boundaries Mode : Selects the Boundaries Mode **Auto** (only the boundaries of the four next levels are shown) or **Manual** (all boundaries are shown). Boundaries Mode applies both to the standard Chart Boundaries and to VAD Boundaries.

Chart Boundaries : Turns the Chart Boundaries **On** (see A) or **Off** (see B). The Chart Boundaries are the "ticked" boxes surround the coastline. Each box indicates an area where more detail is available. The Chart Boundaries are shown with a C-MAP 4D SD CARD or without (shows coverage area of Built-In Charts!).

! ONLY FOR USA.

! While the Boundaries Mode and Chart Boundaries settings are set to Manual and On, respectively, depending on the chart area being displayed and the current zoom level, some degradation in the performance of the CPN Series Chart Plotter may be experienced. If this occurs, it will also be visible as reduced response when using the menus: for example, when a menu item is selected the item might not respond for several seconds: The Boundaries Mode setting of Auto, with Chart Boundaries set to On, provides a combination believed to be adequate for the majority of situations where you want to display the Chart Boundaries.

Chart Boundaries ON



Chart Boundaries OFF



VAD Boundaries : Turns the Value Added Data Boundaries **On** or **Off**. The Value Added Data (VAD) is a collection of additional cartographic objects which are not present on the original paper chart. These objects have been obtained from other sources and then merged to the C-MAP 4D charts in order to provide more information useful for the navigation.



Chart Lock : Turns the chart function **On/Off**. When Chart Lock is On, the available zoom scales are only the ones containing cartographic data. Instead when Chart Lock is Off, it is possible to zoom down into zoom scales not covered by cartographic data. The Safety Status Bar DSI (Data Safety Indicator) window, if present, will show "NO CHART", when the CPN Series Chart Plotter is zoomed into a chart level which does not contain cartographic data.

Underwater Objects Settings

The following selections are used to control which Underwater Objects are shown on the Chart Page.

Underwater Object Limit¹ : Selects the max depth value to display Underwater Objects. If value is set to 0 Ft, the Underwater Objects are not shown on the chart display. If the depth value is set more than 0 Ft (i.e. 10 Ft), depth information will be shown on the chart display from 0 Ft to the selected depth.

Rocks : Sets **Icon/Icon+Depth²** the displaying of the Rocks.

Obstructions : Sets **Icon/Icon+Depth²** the displaying of the Obstructions.

Diffusers : Sets **Icon/Icon+Depth²** the displaying of Diffusers (a Diffuser is a structure usually found on top of a submerged pipe that helps diffuse material into the water, i.e. discharge or wastewater and can be an obstruction to navigation).

Wrecks : Sets **Icon/Icon+Depth²** the displaying of Wrecks.

1 The Underwater Objects shown on the chart display could be up to 3 Ft deeper than the entered value to guarantee a safety tolerance margin.

2 Selections: **ICON** (the object icon is visible, in the range selected from "Underwater Object Depth Limit" option); **ICON+DEPTH** (the object icon and the depth are visible, in the range selected from "Underwater Object Depth Limit" option).

NAVIGATION PAGES

Pages contained on the Navigation Desktop are useful for navigating to a Waypoint or viewing the status of GPS signals.

1. Press the **MENU** key, tap on **Navigation**. In the bottom of the page the available selections appear: **HIGHWAY** opens the Highway Page, **COMPASS** opens the Compass Page and **GPS** opens the GPS Status Page.

Highway Page

Shows a 3D Highway view of the vessel travelling through the water only when navigating

to a destination point, Mark or following a Route.

1. Press the **MENU** key, tap on **Navigation**.
2. Tap on **HIGHWAY**. The Highway Page appears. Data Boxes on the Highway Page can be customized, except for GPS Status (see **8** in the following picture).
3. In the bottom left corner of the Highway page there is a small gray window (see **2** in the following picture) which shows the Scale (width) of the Highway. The default width is 0.2Nm however this may be changed by tapping a finger anywhere on the display to show two Soft Keys. Tap on the **SCALE -** Soft Key or on the **SCALE +** Soft Key to change the scale of the Highway.

- 1 Highway Display
- 2 Highway Scale
- 3 Speed Over Ground
- 4 Course Over Ground
- 5 Bearing to Destination
- 6 Distance to Destination
- 7 Time To Go
- 8 WAAS/GPS Icon

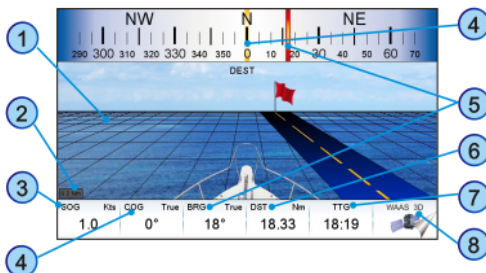

Chart/Highway Page

It is possible to set the Chart Page and the Highway Page on the same screen:

1. Press the **MENU** key, tap on **Chart**.
2. Tap on **& HIGHWAY**.



Compass Page

This page is useful to show information when heading to a destination, following a compass heading or navigating to a Mark or a Route.

1. Press the **MENU** key, tap on **Navigation**.
2. Tap on **COMPASS**. The Compass Page appears. Data Boxes on the Compass Page can be customized, except for Latitude, Longitude, GPS Status, COG and BRG. Tapping anywhere on the screen brings up the **GPS SETUP** Soft Key.

- 1 Fix position
- 2 Time
- 3 Course Over Ground
- 4 Time To Go
- 5 WAAS/GPS Icon
- 6 Speed over Ground
- 7 Bearing to Destination
- 8 Distance to Destination
- 9 Compass Rose

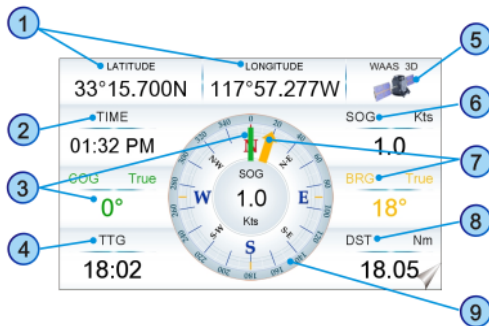

GPS Status Page

This page is used as a reference to see how well the GPS is receiving satellites.

1. Press the **MENU** key, tap on **Navigation**.
2. Tap on **GPS**. The GPS Status Page appears. Data Boxes can be customized, except for Latitude, Longitude and GPS Status.

- 1 Ship's Coordinates
- 2 Date and Time
- 3 WAAS/GPS Icon
- 4 Vertical Dilution of Precision
Horizontal Dilution of Precision
- 5 Tracked, but not used, Satellite
- 6 Used Satellite

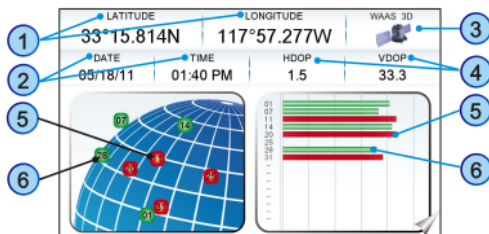

The WAAS/GPS Icon Area **3** may change due to the satellite reception:

ACQUIRING : the GPS is trying to receive a valid position fix.

GPS2D : The GPS is receiving at least 2 valid Satellites.

GPS3D : the GPS is receiving at least 3 Satellites.

WAAS 2D/3D : the GPS is receiving a 2D or 3D position and the correction from the WAAS Satellite.

Setup Menu

From this page it is possible to activate the GPS Setup menu following this procedure:

1. Firstly a tap anywhere on the screen for the Soft Keys to appear is needed (they are not displayed on the page by default and permanently). Then tapping on the **GPS SETUP** Soft Key brings up the GPS Setup menu*. See the following table:

GPS Source	: Allows setting the GPS Source among Internal Antenna , External Antenna and Second CPN . The default setting is Internal Antenna.
Restart GPS	: Restarts all GPS processes. Once executed, the message "Done" is shown.
Navigation Speed	: Allows setting the Navigation Speed (SOG update) among Low and High . The default setting is High.
Speed Filter	: Allows to resolve erratic speed readings in rough seas. Available values are Off , Low , Medium , High . The default setting is Off.

Diff Correction Source : Allows setting what kind of Differential Correction will be used by the GPS between **WAAS/EGNOS** and **None**. The default setting is WAAS/EGNOS.

2. Tap on the preferred item.
3. Press the **CLEAR** key to exit the menu.

!* The GPS Setup menu changes depending if the internal or external GPS is detected and switched on, and also can be different depending on the type of the external GPS used.

WAAS/EGNOS Setting

From the GPS Status page it is possible to disable the WAAS/EGNOS setting following this procedure:

1. Tap anywhere on the screen and then tap on the **GPS SETUP** Soft Key: the GPS Setup menu appears.
2. Tap on **DIFF CORRECTION SOURCE** to select **None** (to disable).
3. Press the **CLEAR** key to exit the menu.

NMEA DATA PAGES

1. Press the **MENU** key, tap on **NMEA**. In the bottom of the page the available selections appear: **DISPLAY** and **DATA**.

NMEA Display Page

The CPN Series Chart Plotter is capable of displaying information in the customizable data windows from external NMEA 0183 devices. Depth sounder, Speed Log with temp, Wind speed and direction, Flux gate compass, and GPS information can be shown in any of the boxes. The NMEA sentences read from external devices are: BWC, DSC, DSE, GGA, GLL, GSA, GSV, HDG, HDM, HDT, RMC, VHW, VTG, DPT, DBT, MTW, VWR, VWT, TLL, WPL, RTE.

1. Press the **MENU** key, tap on **NMEA**.
2. Tap on **DISPLAY**. The 5 NMEA pages can be displayed in circles, from 1 to 6 data boxes pages. Each data box can be customized. The default NMEA Display shows 3 windows:

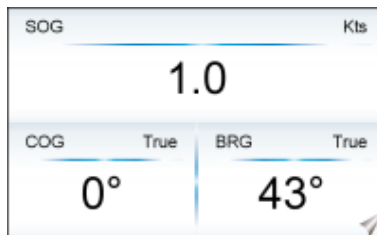

3. Move the **+** ShuttlePoint Knob to the left/right to scroll through all NMEA pages, otherwise tap anywhere on this page for the Soft Keys to appear, and then tap on the desired Soft Key to select the NMEA Display Page you want, for example tap on the **6 BOXES** Soft Key to open NMEA Display Page with six boxes. See the following picture.

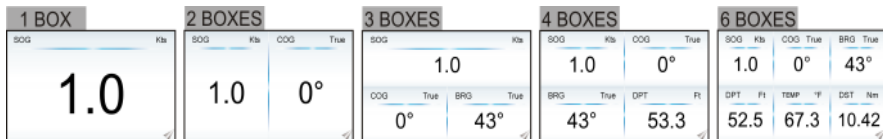

When going to a destination, 3 BOXES is useful to navigate as to get to the destination keep the Course Over Ground (COG) and Bearing (BRG) figures the same.

Customizing data box in the NMEA Display Page

To customize data box please follow the procedure below:

1. Select a NMEA Display page, then press and hold the **MENU** key. One of the data boxes will be highlighted in yellow, release the **MENU** key.
2. Tap on the window to be changed to show a selection popup window.
3. Tap on desired selection.
4. A window will be shown with available options. Tap on the desired option.

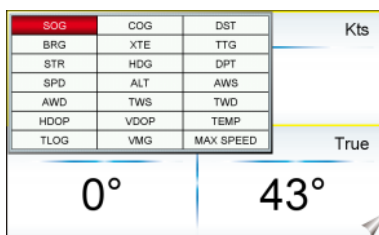

5. Press the **CLEAR** key one time so yellow highlight is removed from the data window.

NMEA Data Page

The NMEA Data page is very useful to see if a external device (example: Depth Sounder) is transmitting NMEA sentences to the CPN Series Chart Plotter. This page can also be used to see if the CPN Series Chart Plotter NMEA output is being loaded down by a external NMEA device the CPN Series Chart Plotter is connected to.

Scenario: VHF Radio connected but the Radio is not receiving a GPS Position. Usually the VHF Radio will be connected to the Green and Brown wires.

To check to see if the CPN Series Chart Plotter is transmitting the sentences:

1. Connect the BLUE Wire on the CPN Series Chart Plotter to the junction of the Brown wire and the VHF wire.
2. Press the **MENU** key, tap on **NMEA**.
3. Tap on **DATA**. The display should look similar to the following picture.

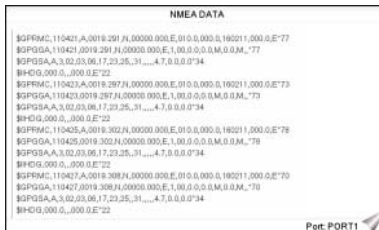

- To freeze the data on the display so it is easy to read and understand, press the **+** ShuttlePoint Knob or the **●** Rotary Knob.
- To unfreeze the data, the **+** ShuttlePoint Knob must be pressed again.
- View data from a device connected to another data port, tap anywhere on this page for the Soft Keys to appear, and then tap on the **PORT** Soft Key: an option window with available ports will appear.

FISH FINDER (OPTIONAL FF525 REQUIRED)

The Fish Finder Icon and page selections may be accessed only when an optional FF525 is connected. After connection the following displays may be shown.

- Press the **MENU** key, tap on **Fishfinder**. In the bottom of the page the available selections appear.
- Tap on the right or left bottom arrow to scroll the Desktop Icons to display the desired icon. From the left:
 - FULL 200kHz** opens the Fish Finder 200kHz Full page
 - FULL 50kHz** opens the Fish Finder 50kHz Full page
 - 200kHz & CHART** opens the Fish Finder 200kHz page on the right side and the Chart page on the left
 - 50kHz & CHART** opens the Fish Finder 50kHz page on the right side and the Chart page on the left
 - DUAL** opens the Fish Finder 200kHz page on the right side and the 50kHz page on the left
 - ZOOM 200kHz** opens the Fish Finder 200kHz Zoom page
 - ZOOM 50kHz** opens the Fish Finder 50kHz Zoom page
 - AUTO** opens the Fish Finder 50/200kHz Zoom page.
- Tap on the desired display. See the example below. For basic connections refer to Connections section. For detailed installation and connections refer to the manual supplied with the FF525.



TIDE PAGE

- Press the **MENU** key, tap on **Tide**. In the bottom of the page 2 available selection appear: **TIDE** and **FIND**.

Tides

The Tide page contains Tide information critical for safe navigation. It is also useful for boaters that are concerned about the height of the water under a bridge or by fisherman that

wish to know the tide and moon phase of a specific date.

1. Press the **MENU** key, tap on **Tide**.
2. Tap on **TIDE**. The page appears and includes information on the moon phase with image, rise and set times and also rise and set times of the sun with an image of the sun.

Moving the **+** ShuttlePoint Knob left and right controls the Tide Prediction time **1** (see the green vertical line which moves as the **+** ShuttlePoint Knob moves) and moving the **+** ShuttlePoint Knob up or down controls the Vessel Draft value **3** (see the orange horizontal line which moves as the **+** ShuttlePoint Knob moves). The yellow vertical line **4** indicates current time and it is displayed only a fix is receiving.

- 1** Tide Prediction Time
- 2** Currently selected date
- 3** Vessel Draft value
- 4** Current Time

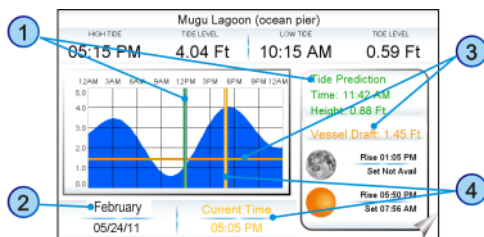

3. Tap anywhere on the screen for the Soft Keys to appear. Tap on the **STATION** Soft Key to open the Find Tide Stations which should find the 20 nearest Tide Stations. When a Tide Station is selected, the related information is displayed on the Tide page. Tap on the **DATE** Soft Key to enter the desired date.

! When activated from the Page Selection menu it displays information related to the fix position or to the cursor position.

None of the data boxes on this page can be customized.

VHF DIGITAL SELECTIVE CALLING

Digital Selective Calling is a semi-automated method of establishing a VHF radio call. DSC had also been designated as part of the Global Maritime Distress and Safety System (GMDSS).

This system allow mariners to instantly send a distress call with GPS position (when connected to the transceiver) to the Coast Guard or other vessels within range of the transmission. DSC will also allow mariners to initiate POSITION Request, POSITION Report calls to or from another vessel equipped with a suitable DSC transceiver.

Compatible VHF Marine Radios with Digital Selective Calling are able to be interfaced with the CPN Series Chart Plotter which feeds GPS data to the VHF and listens for DSC calls from the VHF. By connecting a few wires between the compatible DSC VHF radios and the CPN Series Chart Plotter it will receive:

1. a vessel that has transmitted a DSC Distress call
2. a vessel that has transmitted a DSC Position Send Call
3. The position of a vessel that transmitted a DSC Position Request Call

3. Tap on **ACTIVATE VIDEO** to select the video image type. See the following tables:

Video image types for CPN700i

Full Screen View	: Shows the image from the video camera at full screen.
PIP View	: Shows the image from the video camera on the selected page.

Video image types for CPN1010i

Full Screen View 1	: Shows the image from the video camera 1 at full screen.
Full Screen View 2	: Shows the image from the video camera 2 at full screen.
PIP View 1	: Shows the image from the video camera 1 on the selected page.
PIP View 2	: Shows the image from the video camera 2 on the selected page.

2 Video Input Menu from Video Page Icon





1. Press the  key, tap on Page Icon **Video Input**.
2. Select the video image type: for CPN700i tap on **VIEW1** or **PIP1**, for CPN1010i tap on **VIEW1**, **VIEW2**, **PIP1** or **PIP2** as you want.

After video image type has been selected, the CPN Series Chart Plotter will show a Warning message with the instructions to adjust the image from the Video Input: tap on  to close the Warning window and activate the video in.

- If Full Screen View was selected, the image from the video input will be shown.
- If **Picture in Picture (PiP) View** was selected, a Video Input image is shown on a window and placed over the selected page at full screen. By moving the  ShuttlePoint Knob the PiP image is moved. Press any key to close the PiP image.



Video adjustment mode

Once the Video Input Mode is active, press the  key to enable the video adjustment mode and then use the following keys to adjust video settings:

- press the  key to adjust backlight
- move the  ShuttlePoint Knob up/down to adjust brightness and left/right to adjust contrast
- Press the  key to adjust hue phase
- Press the  key to adjust saturation colors
- Any other key to exit Video Input Mode

Restore Defaults

The video default settings can be restored following the procedure below:

1. Press the  key, tap on **Setup Menu**.
2. Turn the  Rotary Knob or tap on the right bottom arrow to scroll the Desktop Icons to select **VIDEO** and tap on it. The Video Input menu appears.
3. Tap on **RESTORE DEFAULTS**.

ADVANCED SETTINGS

The Advanced Setup menu allows customization of many GPS functions, Alarms and NMEA interfacing.

1. Press the  key, tap on **Setup Menu**.
2. Tap on **ADVANCED**. While in this menu you will see many selections which are described in the next sections.

NAVIGATE MENU

The Navigate menu allows customization of the Coordinate System (Loran TD's), Chart Datum, Chart Orientation Resolution (angle the vessel has to change before the chart is redrawn) and Static Navigation. See the following table:

COORDINATE SYSTEM:	Selections are: a. TD : Time Difference, based on Loran b. UTM : Universal Transverse Mercator Grid c. ddd mm.mmm : Degrees Minutes and Thousands of Minutes d. ddd mm.mm : Degrees Minutes and Hundredths of Minutes e. ddd mm.ss : Degrees Minutes and Seconds
CHART DATUM:	Allows selection of Chart Datums. The default Datum is WGS 1984 as C-MAP by JEPPESEN cartography has been compiled using the WGS84 Datum. A datum is a mathematical model of the earth which approximates the shape of the earth, and enables calculations such as position and area to be carried out in a consistent and accurate manner.
CHART ORIENTATION RES:	Sets the angle the vessel has to change before the chart is redrawn. The default setting is 30 degrees. Example: if the vessel is heading 000T at a speed of 25 Knots, the display will redraw: a. In Home Mode the CPN Series Chart Plotter centers the location of the vessel in the center of the display while it is displayed in the center or on the bottom of the screen (depending on the setting). To keep the vessel in the center of the display the CPN Series Chart Plotter will occasionally redraw. b. If the vessel changes course greater than 330T or more than 30T the chart will be redrawn.
STATIC NAVIGATION:	Sets up a threshold for the speed. When the speed received from the GPS is under the selected value, the CPN Series Chart Plotter displays zero.

Loran TD

The Loran TD selection allows the CPN Series Chart Plotter to be set up so the user can enter in LORAN TD's directly into the CPN Series Chart Plotter. After the TD's have been entered, and the user changes to ddd mm.sss (Degrees Minutes and Seconds) the TD's will be converted to Lat / Lon coordinates. To use the TD Coordinate System the user must setup the Chain and Pair information of the TD's. If you do not know this information, refer to paper charts that show the Chain and Pair information. See the following table:

CHAIN:	Selects the Chain.
PAIR:	Selects the Pair.
ASF1/2:	Additional Secondary phase Factor Correction to TD1/2 values which can be inserted by the user to take in account the additional signal propagation delay over a mixed land/seawater path compared to on all-seawater path. Normally the user does not enter a ASF value. However for experienced users this function allows entering of signal delay values to fine adjust the calculated position. The user should enter delay values to fine adjust the position calculated.

Alter:

Alternate Solution

Parameter selected by the user that is applied in the conversion of geographical coordinates Lat/Lon to TD values. To be used if the position displayed is roughly not correct.

COMPASS (COG) SETUP

The CPN Series Chart Plotter computes compass direction from the constellation of GPS Satellites. For the CPN Series Chart Plotter to compute direction the vessel must be moving through the water to show a COG value. To show the vessels heading when the vessel is not moving a Optional NMEA Heading Sensor (fluxgate compass) must be connected. The Compass menu allows the CPN Series Chart Plotter to customize the following selections:

BEARINGS: Selects between **True** and **Magnetic**. When Magnetic bearings is enabled, the CPN Series Chart Plotter applies the selected Magnetic Variation (Auto or Manual, see next item) to compute Magnetic bearing.

VARIATION: Allows the user to select **Auto** or **manual**. When Auto mode is selected the CPN Series Chart Plotter computes the offset by the current GPS fixed location. Manual mode allows the user to enter in a magnetic variation that is applied in the True conversion.

CALIBRATION: Allows a user to enter a offset for areas that the vessel may cruise instead of entering in a manual offset for one location. This offset is useful for cruising vessels or vessels that travel internationally often.



INPUT/OUTPUT (NMEA) CONNECTIONS

Refer to Connection section for wire description and connection examples.

Input/Output

The CPN Series Chart Plotter has 3 NMEA inputs and 4 NMEA outputs. These Ports may be set up to receive and output the following:

- **NMEA0183** - NMEA devices* set to 4800 Baud (default setting)
- **GPS Auto** - select this option in case of WAAS reception problem with your external GPS Antenna. When this option is set, the Autopilot Output on pin 8 of ACC1 cannot be used anymore (because the output Baud Rate could not be 4800)
- **Fish Finder FF525 50/200kHz BLACK BOX**** - refer to Fish Finder Owner's Manual
- **AIS 38400** - AIS Receiver
- **Disabled** - allows the port to be disabled.

! * RS232 not opto-isolated electrical interface.

! ** Not available on Port 4.

NMEA 0183 output sentences

The ports may be setup to output NMEA sentences. The table below shows the default setting each port:

Sentence	Port1	Port2	Port3	Port4
GLL	On	On	On	On
VTG	Off	Off	Off	Off
BWC	Off	Off	Off	Off
WCV	Off	Off	Off	Off
APA	Off	Off	On	Off
APB	Off	Off	On	Off
HDG	Off	Off	Off	Off
BOD	Off	Off	On	Off
XTE	On	On	On	On
RMA	Off	Off	Off	Off
RMB	Off	Off	Off	Off
RMC	On	On	On	On
GGA	On	On	On	On
HSC	Off	Off	Off	Off
DBT	On	Off	Off	Off
DPT	On	Off	Off	Off
MTW	On	Off	Off	Off
VHW	On	Off	Off	Off
GSA	On	Off	Off	Off
GSV	On	Off	Off	Off

ALARMS

This menu is used to select and setup audible and visual alarms. See the following table:

Arrival Alarm:	Alerts when the vessel is approaching a single destination point or when arriving at a leg in a Route. Available selections: 0.00 to 9.99NM.
XTE Alarm:	Alerts when the vessel is deviating from a defined course. Available selections: 0.00 to 9.99NM.
Depth Alarm:	Alerts when the received depth value from the optional FF525 50/200kHz BLACK BOX FISH FINDER or Depth Finder inputting NMEA data into the CPN Series Chart Plotter is lower than the selected value. Available selections: 0000 to 3000FT.
Anchor Alarm:	Alerts when the ships moves off a selected locations by a selected distance. Available selections: 0.00 to 9.99NM.
Audible Alarm:	Enables or disables the alarm beep.
External Alarm:	Enables or disables the External Alarm. When any alarm condition occurs the red wire is switched from High Impedance to Ground. When purchasing the optional buzzer, choose a 12VDC type with a Max current 400mA or less.
Grounding Alarm:	Looks ahead of the vessels heading to see if a potential danger exists. When the Grounding Alarm is enabled the CPN Series Chart Plotter will draw a triangle in front of the vessel on the Chart Page showing the area that is being searched as shown below. The depth and range (distance) of the area the CPN Series Chart Plotter looks ahead for a shallow area can be set using this function.
Grounding Alarm Range:	Sets the length of the sector to be detected among 0.25 Nm, 0.5 Nm and 1.0 Nm.
Grounding Alarm Report:	Displays the report of the dangerous objects currently detected. When any of the searched objects is found in the scanned area, a tick marker is printed on the relative box to identify which dangerous objects have been currently detected. Once the alarm condition is no longer present, the relative tick marker is removed.



- ⓘ The Grounding Alarm function checks the objects that belong to the standard charts. It does not check the objects belong to the VAD categories.

- ⓘ The Grounding Alarm function is available only if a C-MAP 4D SD CARD is inserted. It also affects the screen redraw speed so we suggest to disable it when not used.

- ⓘ When any of the objects checked are found for the first time, the CPN Series Chart Plotter shows a pop up window to alert the user of the possible danger. The name of each new dangerous object found is reported in the warning window. In the Grounding Alarm Report page the relative item has a tick marker next to it, to identify the dangerous object currently detected. If in the next search cycle the same objects are found again, the alarm window will not be shown. Instead, if in the next searches the objects found before are no longer detected, their relevant item in the Grounding Alarm Report page is cleared (note that in this case, if the same object type is found again later, the Alarm will be shown). The CPN Series Chart Plotter shows an icon on the charts that identifies when a Grounding Alarm is detected.

SIMULATION



The built-in Simulator function allows you to become proficient in the use of the CPN Series Chart Plotter. No current position fix is required because the CPN Series Chart Plotter simulates position data internally.

Simulation Mode:	Three selections: Off: turns the Simulation Mode off On: enables the Simulation Mode, where the speed and course are adjusted by entering in values in the Course and Speed selection discussed later in this table Route: allows you to navigate to a saved Route
Course:	Allows entry of simulated course.
Speed:	Allows entry of simulated speed.
Date:	Allows entry of simulated date.
Time:	Allows entry of simulated time.
Cursor Control:	Enables (On)/disables (Off) the Cursor Control. Moving the  ShuttlePoint Knob up or down will change the SOG and left or right will change the COG of the simulated vessel.
Demo Mode:	In Demo mode the CPN Series Chart Plotter automatically places a Destination point on the Chart page in the cursor location and simulates navigation to the point. Also, the page changes automatically every 10 seconds. The pages are shown in the following order: Main Menu pages, General Chart Page, Highway Page, Compass Page, Tide Page, Chart/Fish Finder, GPS Status Page, chart pages. Once the Demo mode is enabled, pressing any key it is possible to temporally exit and returns to CPN Series Chart Plotter normal operation, but if you do not touch any key for 30 seconds Demo mode restarts.

Navigating a Route in Simulation mode

This selection allows you to navigate to a saved Route to see how data windows on the Chart Page and operation of the Compass and Highway pages.

1. Create a Route.

2. Press the  key, tap on **Setup Menu**.
3. Tap on **ADVANCED**. The Advanced Setup menu appears.
4. Tap on **SIMULATION**. The simulation menu appears.
5. Tap on **SIMULATION MODE**.
6. Tap on **Route**. A window with the Route(s) that are stored in the CPN Series Chart Plotter's memory appears.
7. Tap on the desired Route.
8. Tap on **SPEED**.
9. The touchscreen keyboard appears. Enter in the speed you want to vessel to travel at in simulation mode; when finished tap on , the keyboard disappears.
10. Tap on  to exit to the last selected page.

DSC POLLING

This menu is used to enable or disable features related to the DSC function.

Auto Position:	Selects between Manual or Auto. When Auto Position item is set to Manual and the CPN Series Chart Plotter receives a DSC Position Request or Distress Call from a connected VHF radio, a popup window will not be displayed. When the Auto Position is set to Auto , the CPN Series Chart Plotter works as follows: <ol style="list-style-type: none"> a : when receiving the DSC Distress or Position Request, a popup window is displayed; b : if VIEW ON CHART is selected, the position is indicated on the chart marked with "P" or "D". The cursor is moved to the point "P" and shows the point in the center of the screen; c : when moving the cursor from "P", the location can be confirmed. At this time, the same MMSI Position Request data that were received before are remaining and displayed.
Auto Info:	Enables or disables the Auto Info. This selection is available only when Auto Position is set to Manual. If Auto Info is set to On, when receiving the Position Request it is possible to center the cursor over the top of the Position Request icon and show the Position Request popup window

ABOUT PAGE

The About page contains Software, Chart and optional devices information. To select the About Page follow the procedure below:

1. Press the  key, tap on **Setup Menu**.
2. Tap on the right bottom arrow to scroll the Desktop Icons to display **ABOUT** and tap on it. The About page appears on the screen (see A).
3. Tap anywhere on the screen to display the Soft Keys on the bottom of the page (see B):
 - the **UPDATE FF** Soft Key starts Fish Finder firmware update procedure.
 - the **LICENSE** Soft Key opens the License Page which lists the legal information as copyright and license type. Use the **PREV** and **NEXT** Soft keys to scroll the page and the **CLOSE** Soft Key to exit and return to the About page.
 - ONLY FOR USA: the **SAVE ID** Soft Key saves the Built-In Chart to a optional SD CARD for updating purposes.
 - the **DAM REPORT** Soft Key opens the Data Access Manager Report Page
 - the **REMOVE SD** Soft Key starts the Safety Remove Data Cartridge procedure.

UNIT ID code for updating Built-In Charts Software System Information Cartography Information

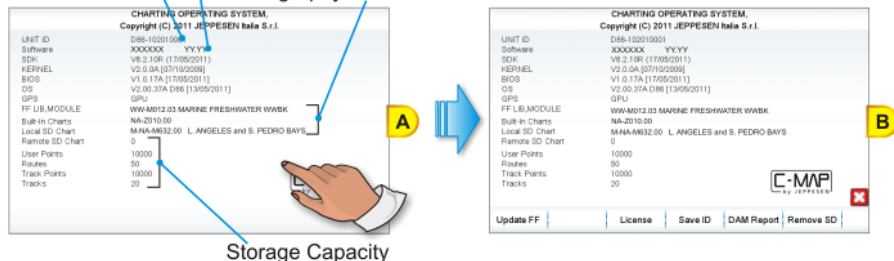

⚠ In the picture above UNIT ID code is ONLY FOR USA.

4. Press the **CLEAR** key to close the About Page.

DAM Report Page

The DAM (Data Access Manager Report for Optional 4D cartography) Report Page contains details about the Subscription, Expiration Date and Data/Features Segmentation status of the C-MAP 4D data cartridge.

1. From About page with Soft Keys shown, tap on the **DAM REPORT** Soft Key (see A): the Data Access Manager Report Page appears (see B).

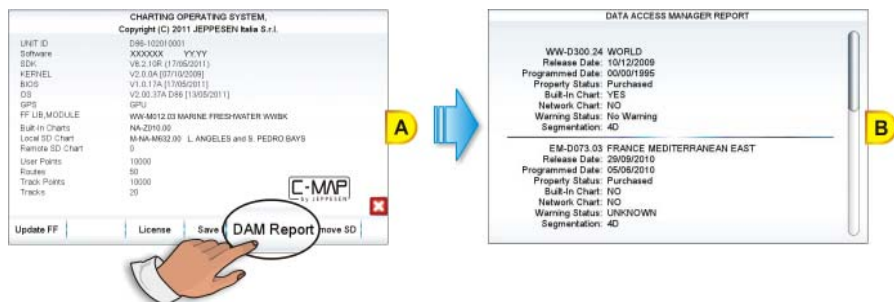

2. Press the **CLEAR** key to close the DAM Report Page and to go back the About Page. In the DAM Report Page the following information are displayed for each chart:

- **Code and Name:** shows the unique code and the name of the chart.
- **Release Date:** is the date when the chart was produced and issued.
- **Programmed Date:** is the date when the chart was programmed on the memory support and the relative chart License was generated.
- **Property Status:** indicates if the chart is rented or sold or other:
 - Purchased** (the cartridge is always enabled)
 - Rental** (the cartridge is enabled until it expires)
 - None** (the purchase type is not defined)
- **Built-In Charts!:**
 - Yes** (the chart is stored in the CPN Series Chart Plotter memory, it could be also in the remote CPN Series Chart Plotter)

- **No** (the chart is on an external device, i.e. SD CARD)
- **Networked Chart:**
 - **Yes** (the chart is on the remote CPN Series Chart Plotter)
 - **No** (the chart is on the local CPN Series Chart Plotter)
- **Warning Status:** reports the specific warning message about the chart's data.
- **Segmentation:** is the kind of data available: 4D, MAX, BASE, invalid chart, currently content not supported.

 ONLY FOR USA.

AIS

AIS is an Automatic Identification System. It has been introduced to improve the safety of navigation by assisting in the efficient operation of ship-to-ship location reporting and VTS applications. The system should enable operators to obtain information from the ship automatically, requiring a minimum of involvement of ship's personnel, and should have a high level of availability. AIS transponders installed on IMO vessels use VHF frequencies to:

- Transmit details of their own vessel
- Receive details from other vessels or navigation aids within VHF range.

CPN Series Chart Plotters are able to display AIS target (for collision avoidance) on the Chart Page and AIS list pages when connected to a AIS receiver (GX2100 or GX2150 STANDARD HORIZON VHF/AIS transceiver) or transponders which output NMEA 0183 VDM sentence at 38400 or 4800 baud. The CPN Series Chart Plotters are able to show targets from both Class A (commercial) and Class B targets.

SYSTEM DEFINITIONS

- **Target:** vessel equipped with AIS. Information about the targets is being received by AIS Receiver and displayed on the screen.
- **CPA** (*Closest Point of Approach*): the closest distance that will be achieved between your vessel and the tracked target, based on your vessel's speed and direction and the target's speed and direction.
- **CPA Limit:** distance from your vessel that a target may reach before a target is deemed a threat.
- **CPA Alarm:** occurs if CPA is less or equal to CPA Limit. This test is done for active targets only.
- **TCPA** (*Time to Closest Point of Approach*): time remaining until the CPA will occur.
- **TCPA Limit:** time remaining before the CPA is reached.
- **TCPA Alarm:** occurs if TCPA is less or equal to TCPA Limit. This test is done for active targets only and if CPA value is less or equal to CPA Limit.
- **Radio Call Sign:** international call sign assigned to vessel, often used on voice radio.
- **Name:** name of ship, 20 characters.
- **MMSI** (*Maritime Mobile Service Identity*) **number:** a unique 9 digit number that is assigned to a DSC radio station. It primarily registers the boat information in the U.S.

Coast Guard's national distress database for use in emergency situations.

- **Active Target:** Target located within the Activation Range. Active target is represented by oriented triangle with COG and Heading vectors. Rate of turn may also be displayed.
- **Dangerous Target:** Target detected by CPA or TCPA Alarm. Dangerous target is Active Target by definition. For better visibility Dangerous Target symbol is flashing.
- **Sleeping Target:** Target located outside the Activation Range. Sleeping target is represented by a small oriented triangle.
- **Lost Target:** When the AIS info is not received from that vessel for 3.5 minutes. The presentation will be a flashing black triangle with a cross through.
- **Activation Range:** Range around your boat where targets become active. AIS target become active within this range. Activation Range should be greater than CPA Limit by definition.



A Target is removed from the screen if data is not received for 10 minutes. The maximum number of tracked Class A or B targets is 200. This information is updated every 3 seconds to 6 minutes depending on speed and rate of turn, enabling the track of the vessels in range to be plotted.

TARGET STATUS	DESCRIPTION	SYMBOL
ACTIVE TARGET	Target located within the Activation Range.	
DANGEROUS TARGET	Target detected by CPA or TCPA Alarm. Dangerous Target is Active Target by definition.	
SLEEPING TARGET	Target located outside the Activation Range.	
LOST TARGET	Ais info is not received from that vessel for 3.5 minutes.	

MENU

To configure the CPN Series Chart Plotter to receive AIS data, follow the procedure:

1. Press the key, move the ShuttlePoint Knob or tap on the right top arrow to scroll the Pages Icons to display **AIS** and tap on it.
2. Tap on **AIS SETUP**. The AIS menu appears. The available functions are described in the following table:

Display	: Turns the display of AIS Targets overlay on the cartography On or Off.
Activation Range	: Defines the range from the fix within which the AIS Target becomes active. The values allowed are from 0.1 to 20 Nm.
CPA Alarm	: Turns On or Off the alarm.
CPA Limit	: The values allowed are from 0.1 to 10 Nm.
TCPA Alarm	: Turns On or Off the alarm.
TCPA Limit	: The values allowed are from 1 to 30 Min.

QUICK INFO ON AIS TARGET

Tap on a AIS Target icon, the following information is displayed.



The selected AIS Target icon is surrounded by a square frame when user places the cursor over the icon.

- 1 Vessel name
- 2 MMSI number
- 3 Speed Over Ground
- 4 Closest Point of Approach
- 5 Radio Call Sign
- 6 Course over Ground
- 7 Time to Closest Point of Approach
- 8 Vessel Type

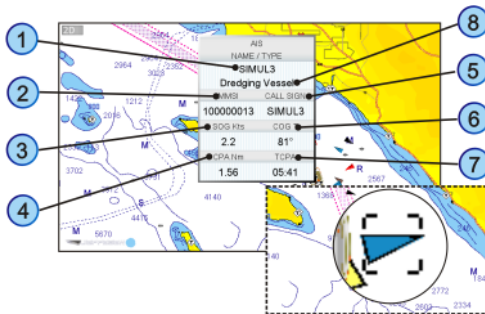

LIST

It is possible to display the AIS List page that shows basic information of the Target ship with the ability to select a Target ship and locate it on the chart.

To select this page follow the procedure:

1. Press the **MENU** key, move the **+** ShuttlePoint Knob or tap on the right top arrow to scroll the Pages Icons to display **AIS** and tap on it.
2. Tap on **AIS LIST**. The AIS List page appears:

AIS LIST							
NAME	CALL SIGN	MMSI	IMO NUMBER	SOG Kts	COG T	CPA Nm	TCPA
SIMUL5	SIMUL5	100000005	100000008	2.0	199°	0.96	---
SIMUL5	SIMUL5	100000008	100000011	2.0	142°	1.10	05:48
SIMUL4	SIMUL4	100000004	100000007	1.3	148°	2.88	---
SIMUL5	SIMUL5	100000000	100000003	1.8	39°	---	---
SIMUL1	SIMUL1	100000001	100000004	1.0	238°	---	---
SIMUL2	SIMUL2	100000002	100000006	3.4	22°	---	---
SIMUL3	SIMUL3	100000003	100000006	3.4	64°	---	---
SIMUL6	SIMUL6	100000006	100000008	4.0	158°	---	---

LOCATE

3. Move the **+** ShuttlePoint Knob up/down to select the Target and scroll the page up/down.
4. Tap on **LOCATE** to show the Target ship on the Chart Page along with the current position of the CPN Series Chart Plotter.
5. Otherwise press the **CLEAR** key to exit the page.

AIS TARGET COLORS

The received AIS Targets are shown in color. The color depicts the type of AIS ship shown on the Chart Page. Refer to following table.

TYPE OF SHIP	GRAPHICAL PRESENTATION
Undefined	▲ (yellow)
Fishing	△ (white)
Pleasure Craft	▲ (light green)
Tanker	▲ (dark blue)
Pilot Vessel	▲ (light gray)
SAR	▲ (black)
Tug	▲ (pale green)
Port tenders	▲ (brown)
Vessels with antipollution facilities or equipment	▲ (light blu)
Low enforcement vessels	▲ (light red)
Medical transport	▲ (dark green)
Vessels according to Resolution N° 18 (Mob-83)	▲ (cyan)
HSC	▲ (red)
Passenger ship	▲ (magenta)
Cargo ship	▲ (dark gray)

CONNECTION MANAGER



GETTING STARTED

The Getting Started section will take you through frequently used operations using the Connection Manager. The Connection Manager allows you to connect to a **Wi-Fi®** Hot spot and to share information between two CPN Series Chart Plotters.

STARTING THE CONNECTION MANAGER

There are two ways to access the Connection Manager, follow the procedure below:

1 From the Chart Plotter Mode

1. Press and hold the  PWR key until the display shows the window below:



2. Tap on **START UP PAGE** to display the Start Up screen.

2 From the Start Up Page

1. Turn on the CPN Series Chart Plotter.

2. When the Start Up display is shown, tap on the Connect Icon  (see A).

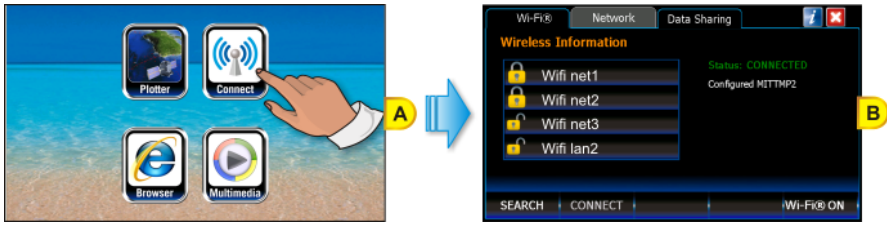

CONNECTION MANAGER OVERVIEW

The first time the Connection Manager is opened, the following window is displayed:

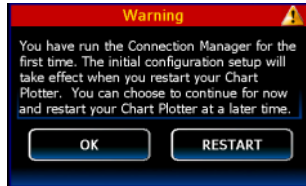







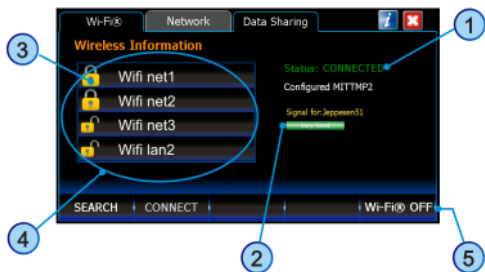







Wi-Fi® CONNECTION

The **Wi-Fi®** tab lists the available Hotspots found by the CPN Series Chart Plotter (see the picture below) and allows connection to a desired Hotspot.

- 1 The status can be:
CONNECTED (green)
NOT CONNECTED (red)
CONNECTING... (yellow)
- 2 Signal Strength: appears only if a Wi-Fi® Hotspot is selected. Red bar indicates a very low to low signal strength and a Green bar indicates good to excellent signal strength
- 3 Locks: open=🔓 no encryption Network closed=🔒 Network (Wi-Fi® password) key required
- 4 Available Wi-Fi® Networks Automatically refreshed
- 5 Soft Keys



CONNECTION MANAGER CONTROLS

KEY / ICON	DESCRIPTION
	Displays the available Wi-Fi® Hotspots list. The list is automatically refreshed
	Open lock:  Wi-Fi® Hotspot is open Closed lock:  Wi-Fi® Hotspot requires a password to access
	Connected to Wi-Fi® Hotspot Not Connected to Wi-Fi® Hotspot Connecting to Wi-Fi® Hotspot
	Signal strength for the selected Wi-Fi® Hotspot. If no Hotspots are selected, the Strength bar is not visible. A red bar indicates Low to Very Low signal; Green bar indicates Good, to Excellent signal
	Shows the actual Wi-Fi® connection status: Tap on  to switch Wi-Fi® ON Tap on  to switch Wi-Fi® OFF
	Tap on to refresh the available Hotspots list The Soft Key changes to  when automatic searching activity is in progress
	Allows to connect to the Hotspot selected in the available Hotspots list
	Tap on to exit the Connection Manager
	Tap on to display the application version
KEYBOARD KEY	DESCRIPTION
	Rotating allows to scroll through received Hotspots

HOW TO CONNECT

1. When the Connection Manager is opened, it automatically searches for available **Wi-Fi®** Hotspots; to manually refresh the list tap on the **SEARCH** Soft Key.
2. Tap on the desired **Wi-Fi®** Hotspot from the list.
3. Tap on the **CONNECT** Soft Key.
4. If the Hotspot has been used before, tapping on the **CONNECT** Soft Key directly tries to connect to the selected Hotspot by using the Authentication Information (password) stored.
5. If the CPN Series Chart Plotter was not connected to the Hotspot before, and the Hotspot requires a Network (Password) Key, the configuration page will be displayed.

 If the Connection Manager has been connected to one or more of the detected Hotspots, it automatically tries to connect to the latest selected Hotspot. If the latest selected Hotspot is no longer available or if it has a weak signal, the Connection Manager tries to connect to the Hotspot with the strongest signal.

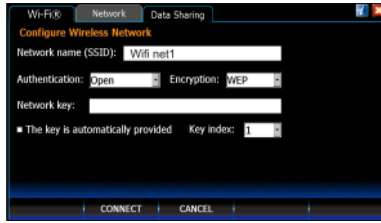

The Connection Manager will show the parameters of the selected Hotspot. To change an item tap on a area next to it and a touchscreen keyboard will appear to insert text into the selected field. When finished, tap on to close the touchscreen keyboard.

Not all Hotspots parameters are correctly detected. Sometimes it is required to manually insert authentication parameters.

6. When all the required fields are filled with the connection data, tap on the **CONNECT** Soft Key. If the connection is successfully completed, the Authentication Information is stored in order to be reused.

The stored authentication information can be changed by double tapping on the desired Hotspot (the configuration page is shown).

AUTHENTICATION/ENCRYPTION PROTOCOLS

The supported Authentication Protocols are the following:

Authentication	Encryption	Description
WEP	OPEN	<i>Wired Equivalent Privacy</i> No authentication key required
WEP	SHARED	<i>Wired Equivalent Privacy</i> Requires a 64/128 bit network key to authenticate
WPA-PSK	TKIP	Wi-Fi ® Protected Access Pre-shared key / Temporary Key Integrity Protocol Requires a 256 bit network key to authenticate
WPA-PSK	AES	Wi-Fi ® Protected Access Pre-shared key / Advanced Encryption Standard Requires a 256 bit network key to authenticate
WPA2-PSK	TKIP	Wi-Fi ® Protected Access II Pre-shared key / Temporary Key Integrity Protocol Requires a 256 bit network key to authenticate
WPA2-PSK	AES	Wi-Fi ® Protected Access II Pre-shared key /Advanced Encryption Standard Requires a 256 bit network key to authenticate

NETWORKING CONNECTION: C-MAP 4D CHARTS, NMEA & FISH FINDER DATA SHARING

The CPN Series Chart Plotter may be setup to share optional C-MAP 4D charts, NMEA 0183 GPS & Fish Finder data (Depth, Temperature and Speed depending on transducer). Data sharing is accomplished between two (only) CPN Series Chart Plotters, one set up as Chart Plotter 1 (the one with the card inserted) and the other as Chart Plotter 2 (the other with no chart inserted). Please note that only the Chart Plotter 1 can have the Vector Chart Sharing enabled. If both CPN Series Chart Plotters are configured with the Vector Chart Sharing option enabled, vector charts will not be shared.

The connection between CPN Series Chart Plotters is accomplished by connecting an optional Crossover Cable between Chart Plotter 1 and Chart Plotter 2 Ethernet connection on the rear panel. The maximum cable length is about 300 Feet or 100 Meters.

 Only vector charts are shared, no satellite or raster charts.

CPN SERIES CHART PLOTTER SETUP

To share C-MAP 4D Charts (and NMEA & Fish Finder data) between two CPN Series Chart Plotters you will need to decide which Chart Plotter will have the C-MAP 4D CARD installed, this Chart Plotter is called Chart Plotter 1. The other Chart Plotter which will read and display information via Ethernet is called Chart Plotter 2.

To setup the two CPN Series Chart Plotters please follow the procedure below:

1. Connect the Ethernet Crossover Cable between the two CPN Series Chart Plotters. Refer to the images below to identify the Ethernet port on your CPN Series Chart Plotter:

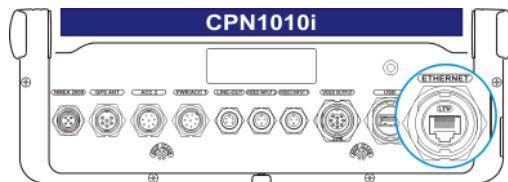
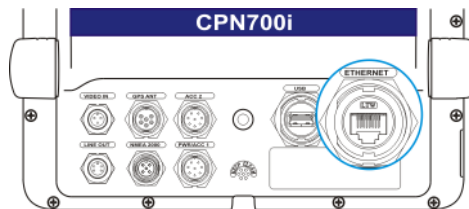

2. Press and hold the  PWR key to turn on both Chart Plotters.

Chart Plotter 1 Setup (with C-MAP 4D CARD inserted)

1. When the Start Up page is shown, tap on the Connect Icon (see A).



2. The next display shown is the Connection Manager (see B), tap on the **Data Sharing** tab:

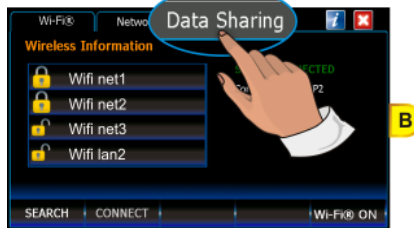

3. Tap on **1** **Vector Chart Sharing** to share Vector Charts inserted in the Chart Plotter 1 with the Chart Plotter 2 (see C):

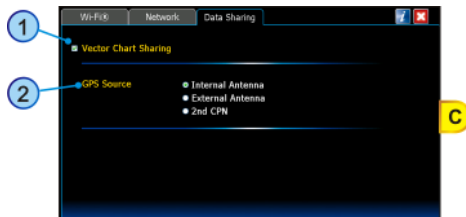

- !** After tapping **Vector Chart Sharing**, the following warning window appears:

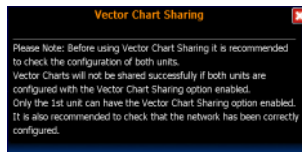

When touched up/down the bar, scrolls the content of the warning window, to display the text in other languages. Tap on **X** to close the window.

4. Tap on one of the GPS Source **2** options - among **Internal Antenna**, **External Antenna** or **2nd CPN** - to select the desired vessel position source.

- ⓘ The proper GPS Source settings depend on the CPN Chart Plotter installation on the vessel.
- ⓘ This setting can be changed anytime from the GPS page in the Chart Plotter application. For more information see Setup Menu into the GPS Status Page paragraph.

5. Tap on the **NETWORK** tab (see D) to configure the network settings:



6. Tap on **1 Chart Plotter 1** to select this CPN Series Chart Plotter as Chart Plotter 1 (see E).

7. Tap on the **APPLY** Soft Key (see E).

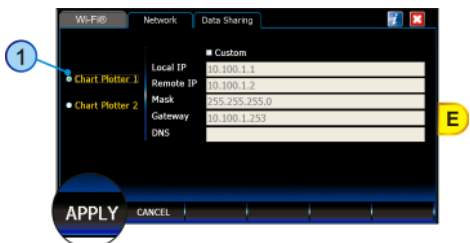

ⓘ If the Chart Plotter number is changed from Chart Plotter 1 to Chart Plotter 2 or vice versa, the following warning popup window appears:

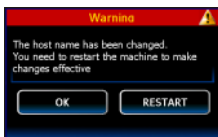

Tap on **RESTART** to apply the changes and restart the CPN Series Chart Plotter. Otherwise tap on **OK** to continue without restart, but the chart sharing functionality will not work until the Chart Plotter is restarted. In this case to restart the Chart Plotter, follow the procedure below:

1. Press and hold the **PWR** key until the display shows the Shut Down window:



2. Tap on **CONFIRM** to turn off the CPN Series Chart Plotter.

Chart Plotter 2 Setup (no chart inserted)

1. When the Start Up page is shown, tap on the Connect Icon (see F).



2. The next display shown is the Connection Manager (see G), tap on the **Data Sharing** tab:

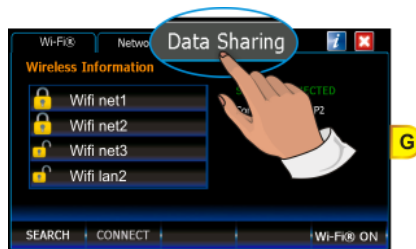

3. Check that **1** **Vector Chart Sharing** (see H) is disabled (otherwise if both CPN Series Chart Plotters are configured with the Vector Chart Sharing option enabled, vector charts will not be shared):

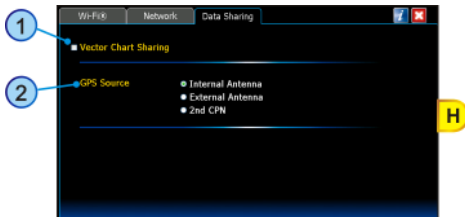

4. Tap on one of the GPS Source **2** options - among **Internal Antenna**, **External Antenna** or **2nd CPN** - to select the desired vessel position source.

! The proper GPS Source settings depend on the CPN Chart Plotter installation on the vessel.

! This setting can be changed anytime from the GPS page in the Chart Plotter application. For more information see Setup Menu into the GPS Status Page paragraph.

5. Tap on the **NETWORK** tab (see I) to configure the network settings:

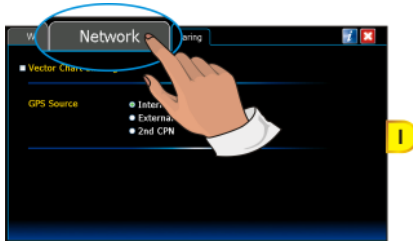

6. Tap on **1 Chart Plotter 2** to select this CPN Series Chart Plotter as Chart Plotter 2 (see L).
7. Tap on the **APPLY** Soft Key (see L).

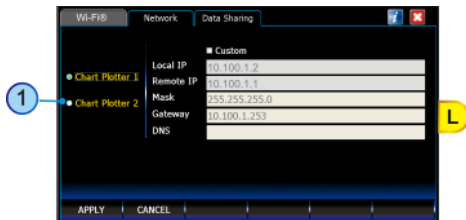

I If the Chart Plotter number is changed from Chart Plotter 1 to Chart Plotter 2 or vice versa, the following warning popup window appears:



Tap on **RESTART** to apply the changes and restart the CPN Series Chart Plotter. Otherwise tap on **OK** to continue without restart, but the chart sharing functionality will not work until the Chart Plotter is restarted. In this case to restart the Chart Plotter, follow the procedure below:

1. Press and hold the **PWR** key until the display shows the Shut Down window:



2. Tap on **CONFIRM** to turn off the CPN Series Chart Plotter.

8. Wait until the Start Up page appears on the CPN Series Chart Plotters display.



9. Tap on the Plotter Icon and confirm the C-MAP 4D charts are shown on Chart Plotter 2. Open the About Page* on both CPN Series Chart Plotters and verify that the

Chart Plotter 1, where the C-MAP 4D CARD is inserted, displays the Chart Code in field “Local SD Chart” and that the same Chart Code is displayed in the Chart Plotter 2 in the “Remote SD Chart” field.

 To display the About Page:

1. Press the  key, tap on **Setup Menu**.
 2. Tap on the right arrow next to **ADVANCED** two times to display **ABOUT** and tap on it.
-

Custom Setup

 TO USE THIS FUNCTION IT IS NECESSARY TO HAVE PC NETWORK KNOWLEDGE.

The Custom Setup is reserved for future software updates where additional Ethernet devices (example Radar, Sounder etc.) may be connected. We **strongly** recommend using Chart Plotter 1 and Chart Plotter 2 setup discussed in the previous section to share Charts and NMEA & Fish Finder data.

INTERNET BROWSER



GETTING STARTED

The Getting Started section will take you through frequently used operations using the Browser. The Browser is a software which allows you to navigate in the web and display Internet pages.

The CPN Series Chart Plotter uses Internet Explorer 6.0. Some web sites may not fully support Internet Explorer 6.0.

STARTING THE INTERNET BROWSER

To activate the Browser as a standalone application, follow the procedure below:

① From the Chart Plotter Mode

1. Press and hold the  PWR key until the display shows the window below:



2. Tap on **START UP PAGE** to display the Start Up screen.

② From the Start Up Page

1. Turn on the CPN Series Chart Plotter.

2. When the Start Up display is shown, tap on the Browser Icon  (see A).

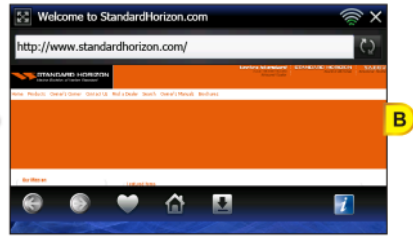

3 Internet Navigation from the Chart Plotter

While in Chart Plotter Mode press the **I** Intelligent key. Tap on Browser Icon to open the Browser application.



Tap on **X** to close the Browser and go back to the Start Up Screen.























BROWSER OVERVIEW





The Browser Home page is displayed when the Browser is launched (see B).

! If no **Wi-Fi**® network connection is available the Connection Manager page is automatically opened. When a connection is established and the Connection Manager is closed, the Browser Home Page is automatically opened.





INTERNET BROWSER CONTROLS

KEY / ICON	DESCRIPTION
	<p>Tapping on this icon Maximizes (shows) or Minimizes (hides) the URL (where the web address is shown) window</p> <p>Tap on  to switch to Minimized mode (see D)</p> <p>Tap on  to switch to Maximized mode (see C)</p>
	<p>Loading indicator: Animated icon displayed to inform the Browser is loading a web site or downloading a file</p>
	<p>Progress bar 1: Shows the loading progress; always visible</p>
	<p>Progress bar 2: Shows the loading progress; visible in Minimized mode only</p>
	<p>Enter the desired URL (web address) and tap on  to open it</p>
	<p>Tapping on  clears the address bar text</p> <p><i>This icon is displayed only while inserting an URL</i></p>
	<p>Tapping on  opens the previous page in browser History</p> <p>Tapping on  opens the next page in browser History</p> <p><i>If no pages have been opened so far, they are not active (disabled and grayed out)</i></p>
	<p>Tap to access Favorite and History pages</p>
	<p>Tapping opens the Home page (www.standardhorizon.com)</p>
	<p>Informs about the download status Tap to access the download list</p>
	<p>Tapping on  stops loading Page</p> <p>Tapping on  reloads the Web page shown in the address line</p>
	<p>This icon shows the signal strength of the selected Wi-Fi® connection</p>
	<p>Tapping exits the Internet Browser</p>
	<p>Tapping informs about the application version</p>

KEYBOARD KEY	DESCRIPTION
	<p>Pressing on  enlarges the displayed fonts</p>
	<p>Pressing on  reduces the displayed fonts size</p>
	<p>Allows to scroll the page in the pressure direction</p>

HOW TO NAVIGATE

At this point you can start the Internet navigation by typing the desired URL (web site address) in the address line. A touchscreen keyboard appears to allow the insertion of the address: when finished tap on , the keyboard disappears. Tapping on  and  places the keyboard on the bottom and top side of the screen.

While browsing sometimes it is need to insert text data or passwords. Tap on the desired field:

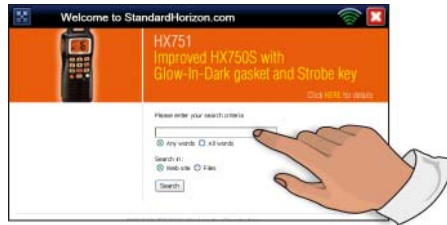

An edit area with the keyboard is opened: tapping on  these data are inserted into the field. See the first example below:



If you need to insert the password, you can decide to show or hide the password by tapping **SHOW PASSWORD** or **HIDE PASSWORD** (see A and B):

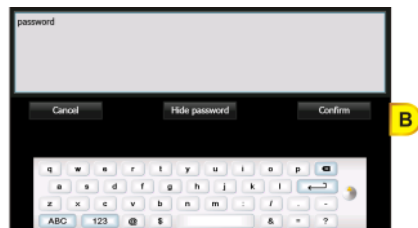
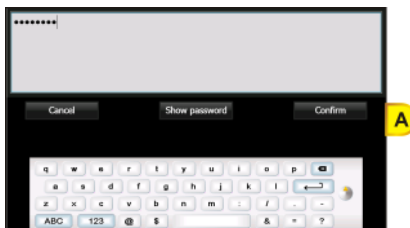

THE SIGNAL INDICATOR ICON

This  icon shows the signal strength of the **Wi-Fi®** Hotspot. When the signal is low or unavailable it may be necessary to open the Connection Manager and connect to another **Wi-Fi®** Hotspot.

If the problem persists, please contact the Access Point supplier.

THE FAVORITE PAGES AND HISTORY LIST

When navigating, you may find a page you wish to recall afterward.

The Internet Browser has a list of pre-defined favorite addresses, but it allows adding and removing pages to and from the Favorite lists. The names of pages added to the Favorite list can be customized.

All the visited pages are automatically saved in the History list.

Displays a list of favorite Internet sites

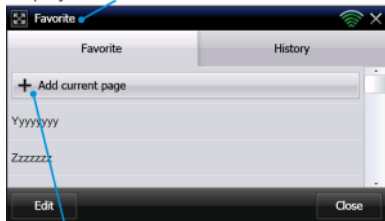

Allows adding a currently opened page to the list

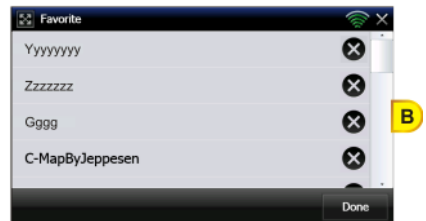

FAVORITES

To display the Favorite/History page tap on  (see A). You can now manage your favorites list:

- tap on **+ Add Current page** to add the currently opened page to the Favorite list.
- tap on the **EDIT** Soft Key to customize the names of pages already added to the Favorite list (see B). Tap on the desired name to edit its label, or tap on  to delete the selected item. Tap on the **DONE** Soft Key to save the change and close.
- tap on the **CLOSE** Soft Key to exit.
- to access the browser History list, tap on **History** (see C):

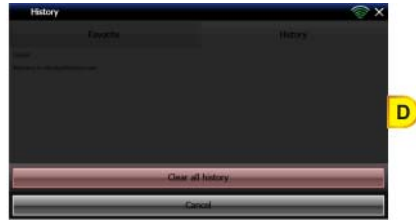
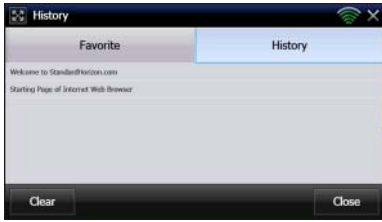

You can recall a page tapping on it from the list or clear the history by tapping on the **CLEAR** Soft Key (see D).

THE DOWNLOAD MANAGER

This section will show how to download files from a web site. The CPN Series Chart Plotters are capable of downloading the following files.

- PDF
- MOV
- OGG

If you try to download file format not present in the above list, a Warning bar will be shown on the Browser, see the image below:

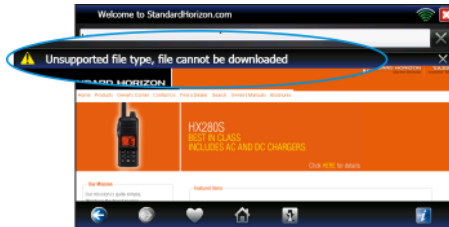

 Pay attention that UNICODE characters are not displayed.

While downloading is in progress, the Download Manager  icon summarizes the download status.

The icon changes and shows the number of downloading files (see A). When the downloading is completed, the icon  appears in green color (see B).





2 downloading files

Tap on  to display the Download Manager pages.

The first page (see C) shows a download in progress: the green bar **1** appears during this operation. If you want to pause the download, tap on the Pause  icon, the bar changes its color from green to orange **3** (see E).

To resume the download, tap on the Resume  icon, the download starts again, the bar becomes green (see C again).

When the download is completed (see D), the bar becomes blue **2** and the Open  icon appears: tapping on  allows to open the file.

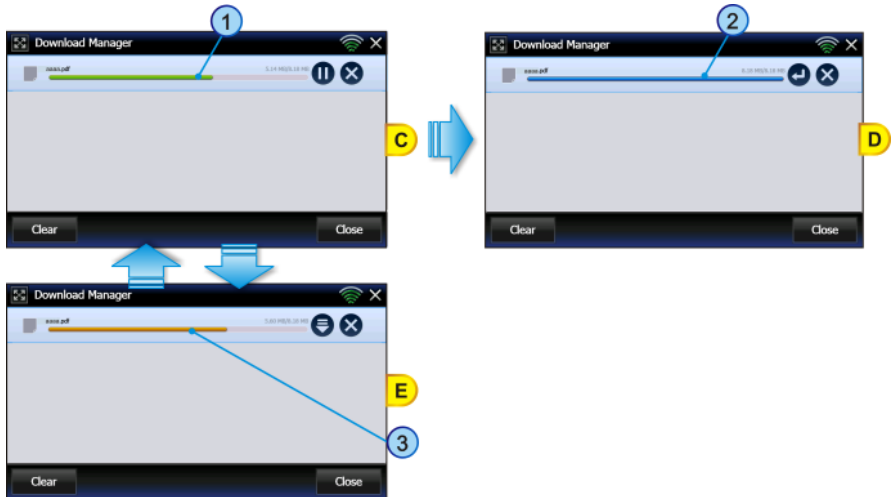

The following picture summarizes the situations you might experience:

- 1** Download in progress
- 2** Download completed
- 3** Download paused

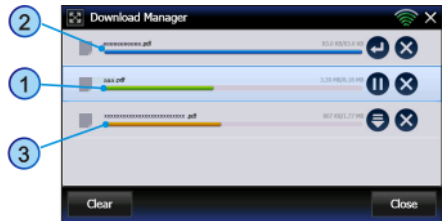

During a download it is possible the CPN Series Chart Plotters memory for storing downloaded files becomes filled. When this happens an "!" icon will appear on the bottom of the page (see A). Tap on  to display the Download Manager page where a warning message is displayed (see B).

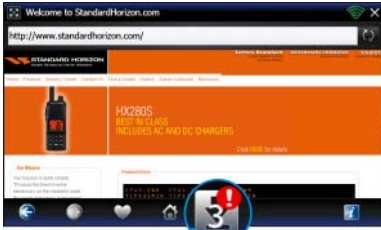

Warning icon

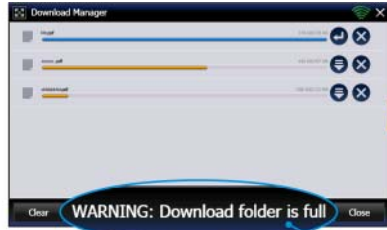

Warning message

To go on, it is necessary to delete a file, by using the Delete  icon which allows file removing.

If you tap on the Delete , two Soft Keys are shown (see C), **DELETE** and **CANCEL** to confirm deletion or not.

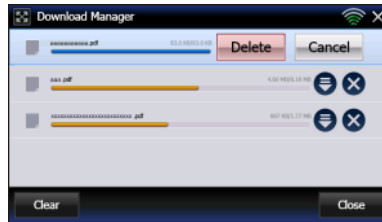

After file deletion, tap on the Resume , to start the downloading again.

 The downloaded files are ONLY available when the Browser is open. When the Browser is closed the files will be deleted.

MEDIA PLAYER



GETTING STARTED

The Getting Started section will take you through frequently used operations using the Media Player functionality. It is possible to open the Media Player functionality in two modes:

- as a standalone application
- as a background application, meaning it can be directly accessed while in Chart Plotter Mode. Only audio files may be played, no video or images files can be viewed while in Chart Plotter Mode.

The Media Player is able to read and play the following formats:

Video:

MPEG-1
3GP
H.264
DivX
Xvid
QuickTime
MOV

Audio:

MP3
Wave
AIFF
FLAC
Ogg Vorbis
VMA8
VMA9
AU

Image:

BMP Decoder
GIF Decoder
JPG Decoder (VPU+SW)
PNG Decoder

STARTING MEDIA PLAYER

To activate the Media Player functionality as a standalone (not using the Chart Plotter) application, follow the procedure below.

1 From the Chart Plotter Mode

1. Press and hold the  PWR key. The display shows the window below:



2. Tap on **START UP PAGE** to display the Start Up screen.

2 From the Start Up Page

1. Turn on the CPN Series Chart Plotter.

2. When the Start Up display is shown, tap on the Multimedia Icon (see A).











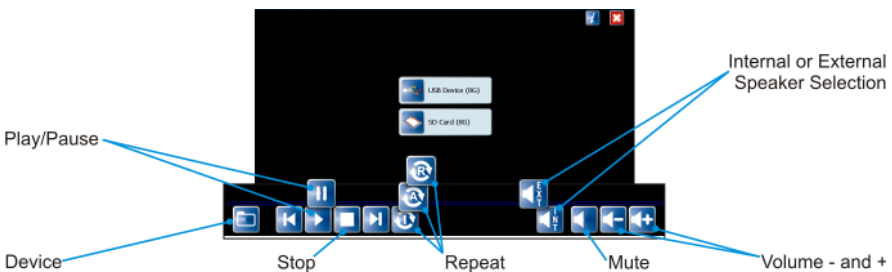













3 Simultaneous Multimedia Music and Chart Plotter

While in Chart Plotter Mode press the **f** Intelligent key. Tap on Multimedia player Icon to open the player and tap on a folder and a music file to start playing it. Press the **f** Intelligent key to toggle between the Multimedia player and Chart Plotter Modes.



MEDIA PLAYER CONTROLS

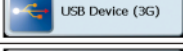
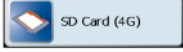

KEY	DESCRIPTION
 Folder	Opens the last selection on the USB Flash Drive or the SD CARD. If tapped again, or tapped while playing an audio file, the device list is shown. The following pressures will cycle between these items
 Reverse	Selects the previous (video, image or audio) media file in the folder
 Play / Pause	Switches between two functions:  Tap on to start playing the selected video, image or music file or to resume after pausing  Tap on to pause a video, image or music file
 Stop	Stops playing the selected video, image or audio file
 Forward	Selects the next (video, image or music) media file in the folder
 Repeat control	Switches among three functions:  Default setting, plays all video, images or audio files and then repeats  Play one video, image or audio file, then stops  Repeats a video, image or audio file until stopped
 Front Speaker	Switches between two functions:  Front speaker On  Front speaker Off The speaker selection setting is saved and used at the next startup
 Mute / Un-Mute	Switches between two functions:  Shown when audio is muted. Tap on to un-mute the speakers  Shown when audio is playing. Tap on to mute the speakers
 Volume Down	Tap on to decrease the volume on step Tap on and hold to decrease the volume quickly
 Volume Up	Tap on to increase the volume on step Tap on and hold to increase the volume quickly
 Exit	Tap on to exit the Multimedia player
 Info	Informs about application version
 USB Device (3G)	Shown when a USB Flash Drive is inserted into the front (a micro USB A male to USB B female adapter is required) or inserted into the rear panel USB connector. Tapping on this icon opens the USB folder to show files saved on it
 SD Card (4G)	Shown when a SD CARD is inserted into the SD CARD slot. Tapping on this icon opens the SD CARD folder to show files saved on it. If a C-Map 4D Card is inserted, the contents of the C-Map Card will be shown

SAVING FILES ON A USB THUMB DRIVE

The example below refers to a PC with Windows XP Operating System. Other versions of Windows may be slightly different.

1. Connect a USB Thumb Drive to a PC which you have stored videos, images and music files on.
2. If the AutoPlay functionality is enabled, the following window will be displayed:



In this case double click on **OPEN FOLDER TO VIEW FILES USING WINDOW EXPLORER.**

Otherwise open **MY COMPUTER** and double click on the USB device (e.g. USB Disk, Removable Disk ...).

3. The content of the device will be displayed:

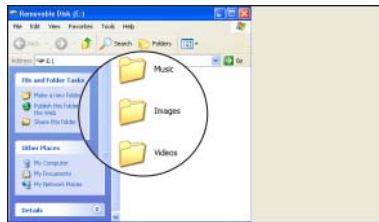

Create directories to save files to, example Music, Images, Videos or name of Artist etc. Creating these folders will make it easier when using the Multimedia to view images, play music or videos.

4. Save files into the proper folders on the USB Thumb Drive.
5. Safely eject the USB Thumb Drive from the PC.

VIEWING AND PLAYING FILES

1. Start the Multimedia Player from the Start Up Menu (see A) or by pressing the **I** Intelligent key on the front of the CPN Series Chart Plotter when in Chart Plotter Mode.



2. Tap on the USB device icon to see the folders saved on the device (see B):

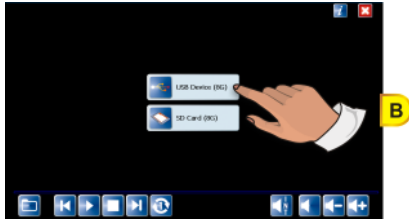

3. Tap on the folder to be viewed (example Music), see C:

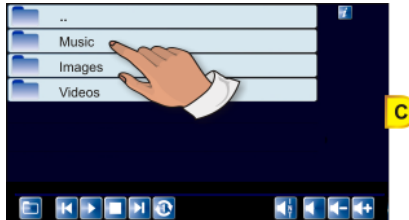

4. Tap on the Multimedia file to play (see D):



The selected multimedia file will automatically begin to play.

INSTALLATION

MOUNTING THE CPN SERIES CHART PLOTTER

The CPN Series Chart Plotters are supplied with a swivel mounting bracket which allows them to be dash mounted. When flush mounting, the optional GPS Antenna may be needed to receive GPS satellite signals. Refer to the images below for bracket installation:

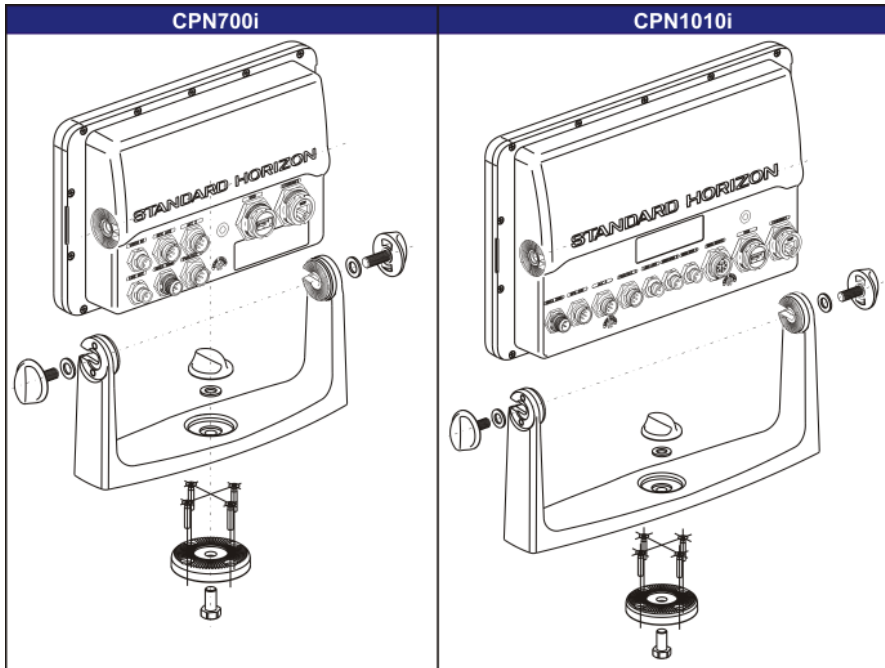

⚠ When choosing a location to bracket mount a CPN Series Chart Plotter it is advisable to temporarily connect the plotter to power, enter Chart Plotter mode and check the signal strengths by touching on the Navigation icon, and touching the GPS Status icon. If the GPS satellite signals are low or the plotter cannot receive a fix, an optional GPS Antenna may be purchased and installed. Refer to Introduction section in the Optional Accessories paragraph.

⚠ To swivel the bracket, loosen the center mounting knob and turn the CPN Series Chart Plotter to the left or the right. When finished re-tighten the mounting knob.

BRACKET MOUNTING

Before installing ensure the area the bracket is mounted to is strong enough to support the

weight of the CPN Series Chart Plotter especially while under way. After the location is found, attach the mounting base to the area using the supplied hardware (see the picture above).

FLUSH MOUNTING THE CPN SERIES CHART PLOTTER

The CPN Series Chart Plotters are supplied with a flush mount cutout template and a flush mount kit. Refer to the images below as a guide to installing.

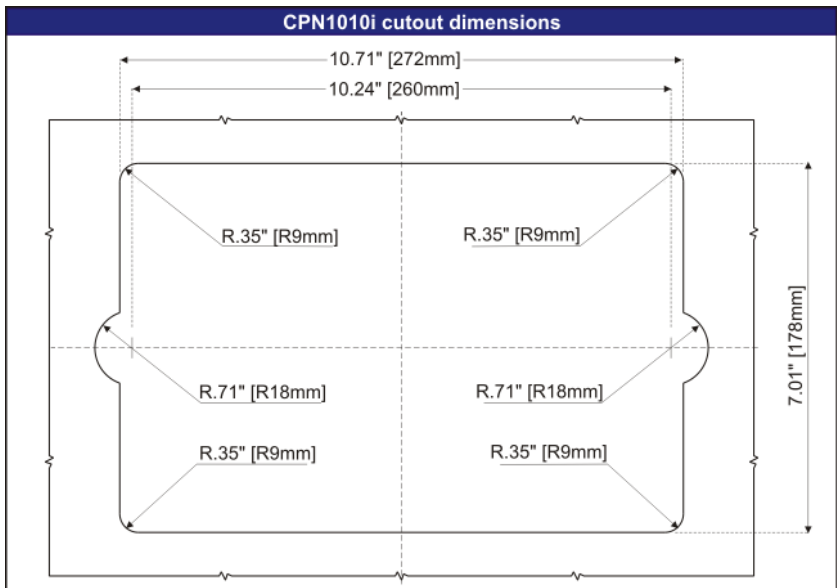
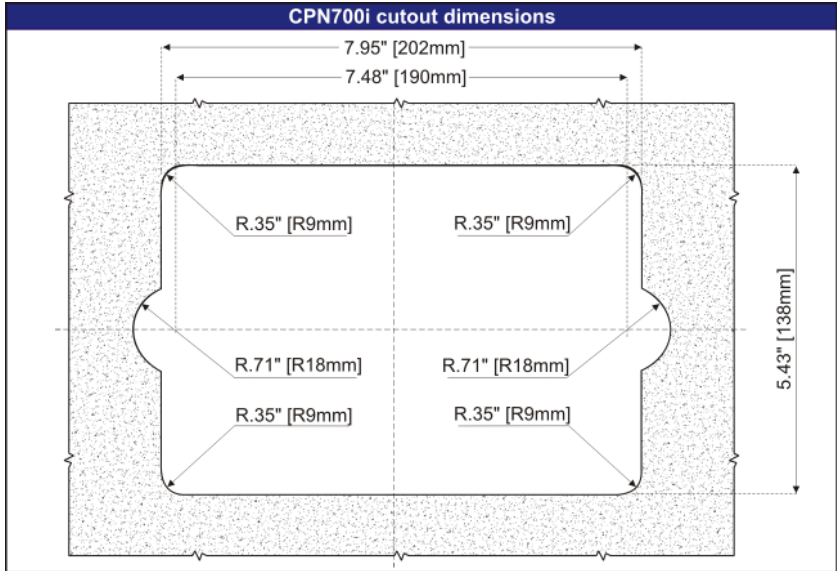

! Before drilling holes make sure there is enough room to mount the CPN Series Chart Plotter and there are no obstructions.

1. After a location is found, peel the template label from the backing and apply the label to the mounting area.
2. Drill a hole in one area of the cutout area that will allow the blade of a jig saw to be inserted. Insert and cut out the area on the panel using the jig saw.
3. Next drill the four holes required to insert the CPN Series Chart Plotter with the mounting studs.
4. Install pieces into mounting holes on side of CPN Series Chart Plotter before inserting plotter into mounting hole.

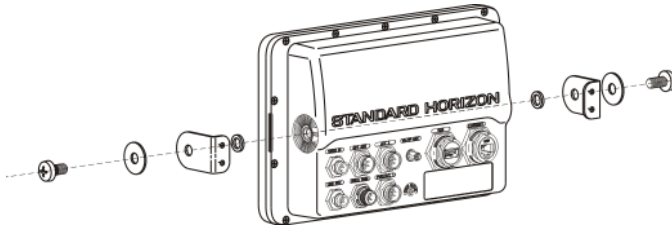

5. Slide the CPN Series Chart Plotter into the dash of mounting hole.

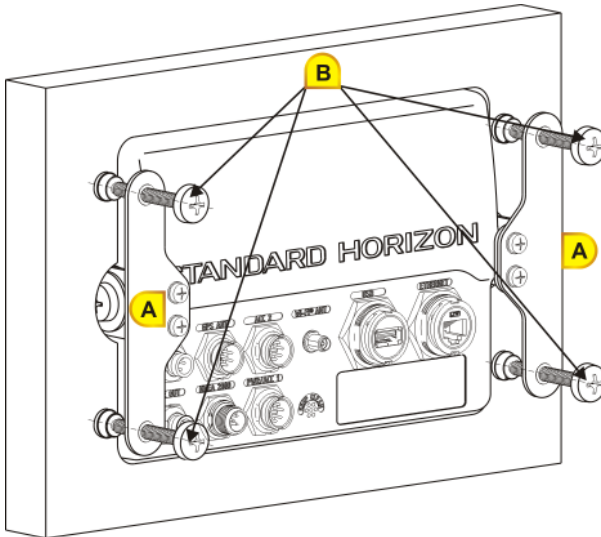

6. Install the left and black brackets using the four lock washers and 4 screws (see A).
7. Tighten the four tension screens to hold the CPN Series Chart Plotter into the panel (see B).

MOUNTING THE OPTIONAL EXTERNAL GPS ANTENNA

An external WAAS GPS antenna is available when the CPN Series Chart Plotter is flush mounted or mounted in an area where satellite reception is not possible with the internal antenna. This antenna is designed to be mounted on a base, installed on an extension or flush mounted.

Choose a location for the antenna that has a clear view of the sky and is not located within 3Feet of a Radar or other transmitting antennas. Ensure there are no major obstructions or fixtures in the immediate proximity to the antenna. The antenna relies on direct "line of sight" satellite reception. If you are unsure of the chosen location, temporarily mount the antenna in the desired location to verify correct operation. If mounted close to Radar, after the CPN Series Chart Plotter has a fix, turn on the Radar to ensure the CPN Series Chart Plotter holds the fix (use the GPS Status Page).

The thread used on the antenna is an industry standard (1inch 14TPI) used on a wide range of mounting brackets.

! The antenna cable can be cut and spliced to ease installation. Care must be taken when reconnecting the antenna cable to protect from water and corrosion.

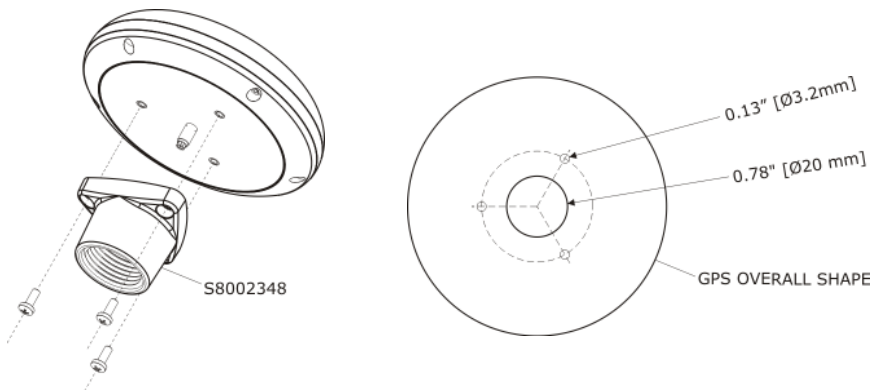

FLUSH MOUNTING THE ANTENNA

! Before drilling holes, it is recommended the antenna be positioned where the location is planned, cable connected to the CPN Series Chart Plotter and power turned on to ensure a GPS Fix is received.

1. To ease installation a flush mounting template for the antenna has been included.
2. Apply the mounting template sticker to the area that was verified for GPS reception.
3. Then, drill out the 0.78" (20mm) and 0.13" (3.2mm) holes, and remove the template.
4. Insert the cable into the 0.78" (20mm) hole and route to the CPN Series Chart Plotter.
5. Apply a small amount of RTV to the underside of the antenna and place onto mounting surface. Allow time for the antenna to adhere to the mounting surface.

CONNECTIONS

OVERVIEW

The CPN Series Chart Plotter has connectors that allow it to be connected to:

- Battery Connections
- NMEA 0183 Devices (VHFs, AIS Receiver, Digital Instruments and Autopilots)
- Optional FF525 BLACK BOX FISH FINDER
- Optional Video Camera
- Optional monitor with VGA input (CPN1010i)
- Optional GPS Antenna
- Optional Audio Amplifier and speakers
- Optional USB memory stick
- Optional External Alarm
- Second CPN Series Chart Plotter to share C-MAP 4D charts
- NMEA 2000 devices (for future release)
- Ethernet Radar (for future release)

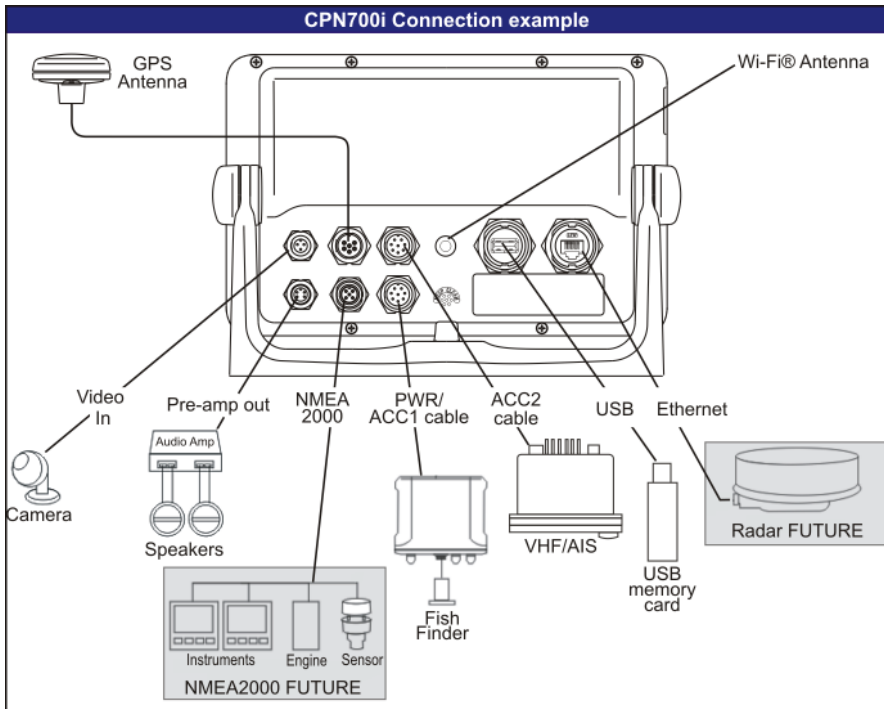

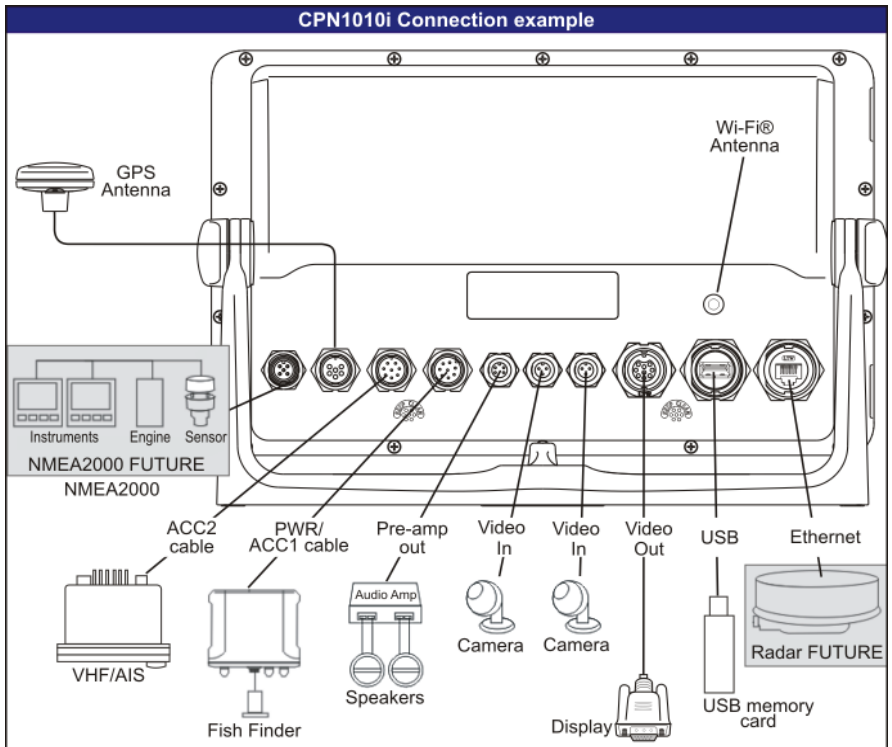

BATTERY CONNECTIONS

1. The CPN Series Chart Plotter is supplied with a fuse and holder. This fuse should be installed into the Black wire to protect the NMEA Output/Input circuits from becoming damaged, however it can also be installed in the red wire.
2. Two Accessory cables (exactly the same cable) are supplied with the CPN Series Chart Plotter.
3. Connect one of the Accessory cables to the PWR ACC 1 connector on the rear panel. The other Accessory cable is used to connect to ACC 2 connector.
4. This cable has many wires, however only the RED and BLACK wires are used to connect to a switched battery supply. Refer to the following images. For additional connections refer to NMEA 0183 Connections section.

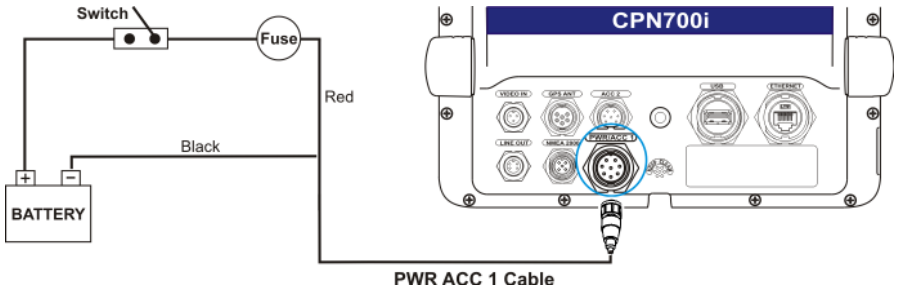

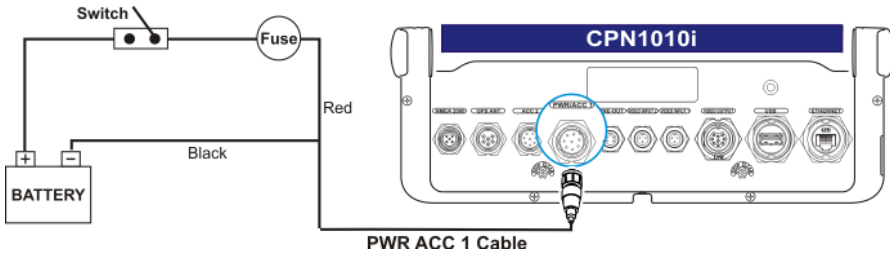

NMEA 0183 CONNECTIONS

⚠ The CPN Series Chart Plotter are supplied with two accessory cables. These two cables may be connected to PWR/ACC1 or ACC2 connections.

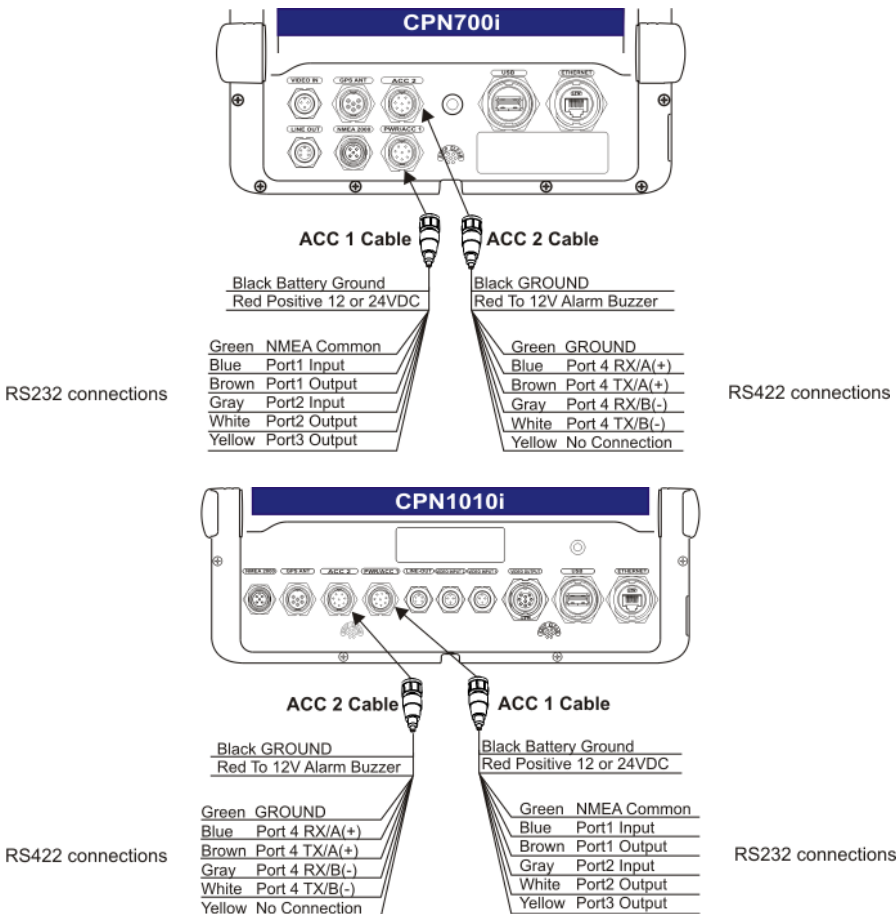

PWR/ACC 1 Cable				
Pin	Cable Wire Color	Description	Connection Example	Additional Comments
1	Black	Battery Ground	Connect to Battery Ground	
2	Red	Battery Positive	Connect to Battery Positive	Voltage range 12-24VDC
3	Green	Common (ground) for NMEA devices	Connect to signal common	
4	Blue	Port 1 Input (*)	Connect to Output of NMEA device	Default is NMEA0183
5	Brown	Port 1 Output (*)	Connect to Input of NMEA device	Default is NMEA0183 with GSA, GSV, GGA, GLL, RMC, XTE, DBT, DPT, MTW, VHW sentences
6	Gray	Port 2 Input (*)	Connect to FF520 or FF525	Default is Fish Finder
7	White	Port 2 Output (*)	Connect to FF520 or FF525	Default is Fish Finder
8	Yellow	Port 3 Output (*)	Connect to Input of NMEA device (*), shared with GPS	Default is NMEA0183 with APA, APB, BOD, GGA, GLL, RMC, XTE sentences (*) RS232 not opto-isolated

ACC 2 Cable				
Pin	Cable Wire Color	Description	Connection Example	
1	Black	GROUND		
2	Red	ALARM	When any alarm Condition occurs the red wire is switched from High Impedance to Ground. When purchasing the optional buzzer, choose a 12Vdc type with a Max current 400mA or less.	
3	Green	GROUND		
4	Blue	Port 4 Input RX /A (+) (*)	Connect to TX /A (+) Output of NMEA device	
5	Brown	Port 4 Output TX /A (+) (*)	Connect to RX /A (+) Input of NMEA device	
6	Gray	Port 4 Input RX /B (-) (*)	Connect to TX /B (-) Output of NMEA device	
7	White	Port 4 Output TX /B (-) (*)	Connect to RX /B (-) Input of NMEA device	
8	Yellow	NC	NC	

(*)RS422, NMEA0183 opto-isolated, 38400baud max speed

PWR/ACC1 Connections

PWR/ACC1 contains 3 NMEA RS232 type outputs and 2 NMEA RS232 type inputs (RS232 has one common NMEA Signal ground).

ACC 2 Connections

ACC2 contains 1 NMEA RS422 (A and B signal wires) type Port.

PORT Input selections

Each Port may be configured to be able to connect to specific devices:

- NMEA0183 4800 Baud
- GPS Auto¹ - select this option in case of WAAS reception problem with your external GPS Antenna. When this option is set, the yellow wire on PWR/ACC1 cable is disabled.
- Fish Finder¹ - select when optional FF525 is connected (Port 2 default set to Fish Finder).
- AIS 38400 - select when AIS receive or transponder is connected to an input
- Disabled - disables the Port

ⓘ Not available for ACC2.

To change a selection follow the procedure below:

1. Press the **MENU** key, tap on **Setup Menu**.
2. Tap on **ADVANCED**.
3. Tap on **IN/OUT Connections**.
4. Tap on the Port Input to be changed, than tap on the desired input.
5. Press the **CLEAR** key to exit the menu.

PORT Output sentences

When NMEA-0183 4800 is selected the CPN Series Chart Plotter allows selection of the following NMEA output sentences: GLL, VTG, BWC, WCV, APA, APB, HDG, BOD, XTE, RMA, RMB, RMC, GGA, HSC, DBT, DPT, MTW, VHW, GSA and GSV.

To enable or disable Output sentences follow the procedure below:

1. Press the **MENU** key, tap on **Setup Menu**.
2. Tap on **ADVANCED**.
3. Tap on **IN/OUT Connections**.
4. Tap on the Port Output Sentences.
5. Tap on the desired sentence to enable or disable.
6. Press the **CLEAR** key to exit the menu.

CPN Series Chart Plotter to NMEA 0183 connection examples

1 VHF Radio Connection Example - RS232 and RS422 Connections

The image below shows how a VHF radio with RS232 Connections (NMEA Common/Ground) or RS422 type (A&B Signal wires) may be connected.

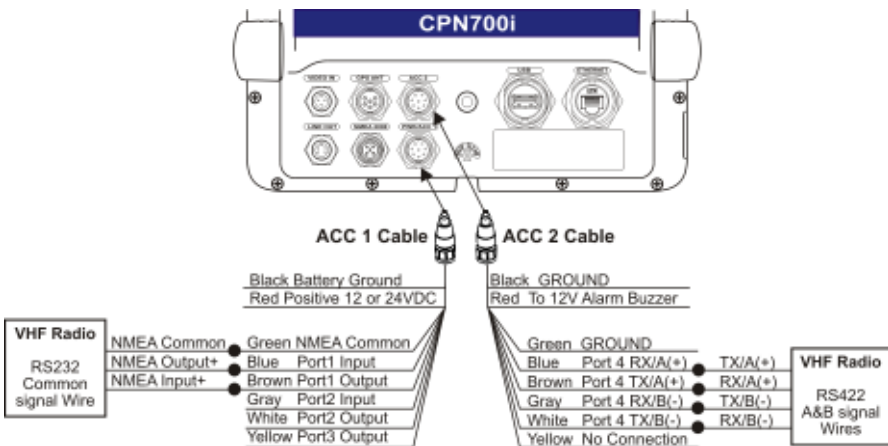

2 Fish Finder and VHF/AIS and Autopilot Connection

By default the CPN Series Chart Plotters PWR/ACC1 Port 2 connection is set to Fish Finder. When an optional FF520 or FF525 is connected Port 2 Input (Gray) and Output (White) wires are not used for connections to other devices.

3 VHF/AIS Radio (GX2100 or GX2150) Connections (RS232)

CPN Series

*Port 1 set to NMEA 4800

**Port 2 set to AIS 38400

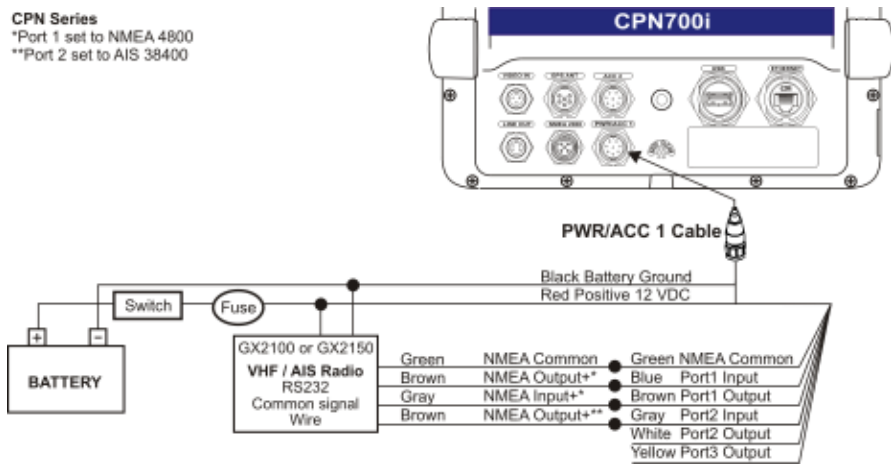

VIDEO INPUT CONNECTOR

CPN700i/CPN1010i VIDEO Input Connector		
Pin	Description	Connection Example
2	Ground	Connect to Video Signal Ground of DVD/VCR/Video Cameras
3	NC	NC
1	Video Signal+	Connect to Video Signal+ (NTSC/PAL) of DVD/VCR/Video Cameras

VIDEO INPUT CONNECTIONS FOR CPN700i

The CPN700i has:

- **1 NTSC or PAL Compatible Input:** NTSC or PAL video input allows a camera, DVD or VCR to be connected. To connect a video source use the optional ACVC10 cable (3 pin to RCA phone adapter).

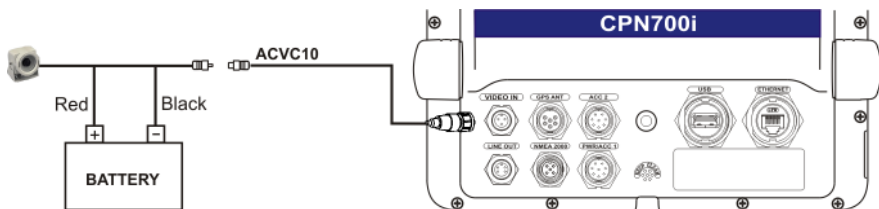

VIDEO INPUT/OUTPUT CONNECTIONS FOR CPN1010i

The CPN1010i has:

- **1 VGA output:** allows connection to a compatible TV or monitor using the optional VGAC10 adapter cable.
- **2 NTSC or PAL Compatible Inputs:** NTSC or PAL video inputs allow a camera, DVD or VCR to be connected. To connect a video source use the optional ACVC10 cable (3 pin to RCA phone adapter).

! The CPN1010i VGA output resolution is 1024x600. To be able view the CPN1010i display, the monitor (or TV) must be selected to a resolution of 1024x600.

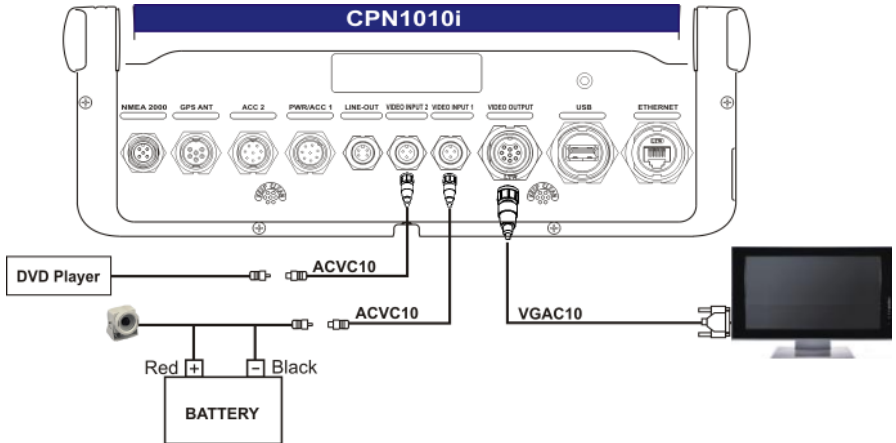

CPN1010i VIDEO Output Connector

Pin	Description
1	VIDEO-GND
2	NC
3	Video-Red
4	Video-Green
5	Video-Blu
6	H-Sync
7	V-Sync
8	NC
9	NC

PRE-AMP OUTPUT - EXTERNAL AMPLIFIER/SPEAKER CONNECTIONS

The CPN Series Chart Plotter have a Pre-Amp Output designed to connect to an External Amplifier. To connect an External Amplifier to the Pre-Amp Output an optional ACAC10 adapter cable will have to be purchased separately. The following is an example of connections:

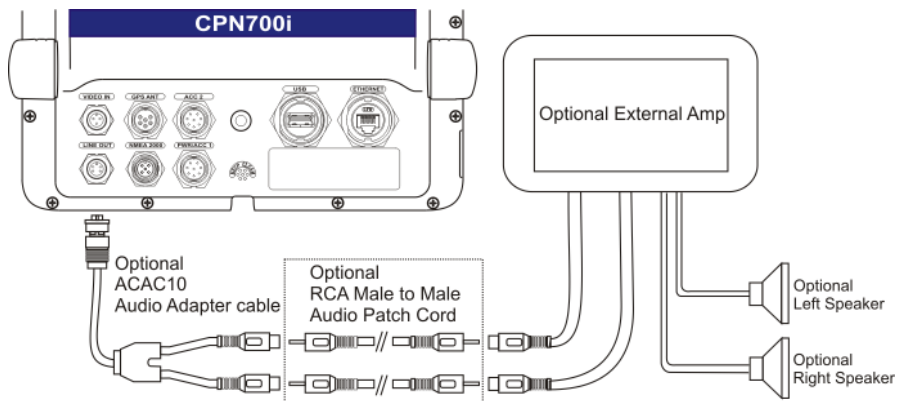

CPN Pre-Amplifier connector pin out

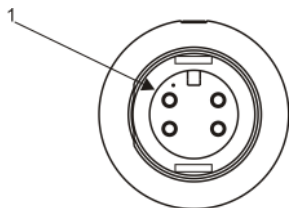

CPN700i/CPN1010i LINE Output Connector	
Pin	Description
1	Channel right +
2	Channel right - (GND)
3	Channel left +
4	Channel left - (GND)

OPTIONAL USB THUMB DRIVE

A USB thumb drive may be connected or removed from a CPN Series Chart Plotter rear panel connector at any time. The thumb drive may be loaded with the movies, pictures and songs from a PC before inserting and be accessed using the Media Player (refer to *Media Player* section). Below is an example of USB thumb drive connection:

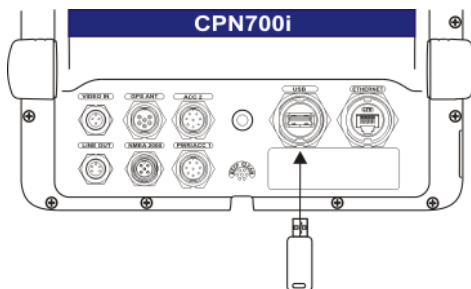

OPTIONAL EXTERNAL ALARM CONNECTION

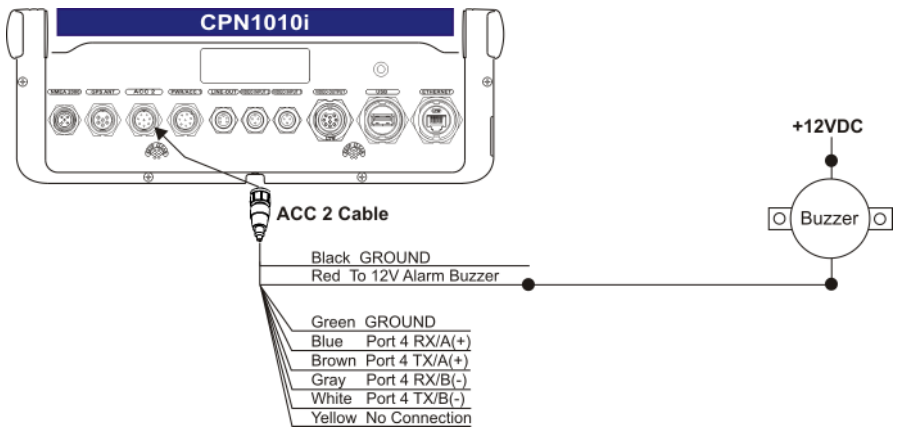
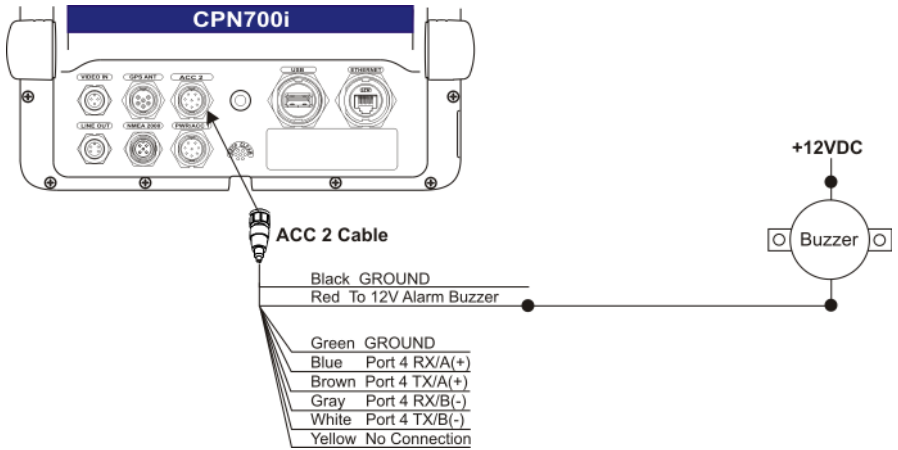

OPTIONAL GPS ANTENNA

Refer to Optional WAAS GPS Receiver section.

OPTIONAL FF525 BLACK BOX FISH FINDER

Refer to Optional FF525 FISH FINDER section.

SECOND CPN TO SHARE C-MAP 4D CHARTS, NMEA & FF DATA

Two CPN Series Chart Plotters may be linked together using an optional Ethernet Crossover cable to share Optional C-MAP 4D cartography, NMEA and Fish Finder data. Connections are shown below. Refer to *Connection Manager* section, *Networking Connection: C-MAP 4D Charts, NMEA & Fish Finder Data Sharing*.

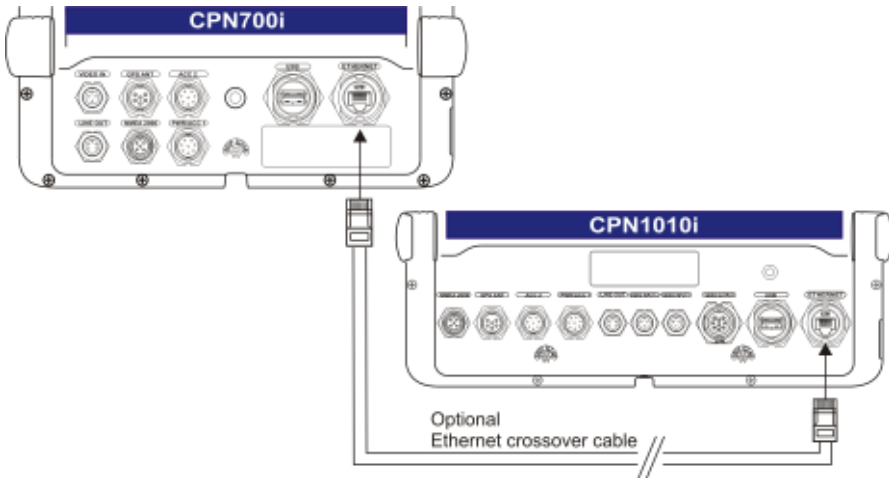

NMEA 2000 DEVICES and ETHERNET RADAR (for future release)

Standard Horizon will be releasing software updates the CPN Series Chart Plotters which will allow connection of NMEA 2000 devices and Ethernet Radar. Check with your dealer or visit www.standardhorizon.com in the CPN700i or CPN1010i sections for updates.

SPECIFICATIONS

CPN700i

Power Supply	: 12-24 VDC
Power Consumption	: 11W max Current Draw: 0.92A@12VDC
Display	: 7" Wide VGA Resolution: 800x480 Sunlight viewable Backlight: LED (1000nits) Touch screen: Capacitive
Cartography	: C-MAP 4D SD CARD
Operating temperature range	: 32°F/+131°F (0°C/+55°C)
Storage temperature	: -4°F/+158°F (-20°C/+70°C)
Keyboard	: Silicon rubber, LED backlight
Weight (without bracket)	: 2.7 Lbs (1200 gr)
User Points (Marks/Waypoints)	: 10000
Routes	: 50
Track Points	: 10000 (recordable in 20 Tracks)
NMEA 0183 Output sentences	: GLL, VTG, BWC, WCV, APA, APB, HDG, BOD, XTE, RMA, RMB, RMC, GGA, HSC, DBT, DPT, MTW, VHW.
NMEA 0183 Input sentences	: BWC, DBT, DPT, DSC, DSE, GGA, GLL, GSA, GSV, HDG, HDM, HDT, MTW, MWD, MWV, RMC, RTE, TLL, VDM, VHW, VTG, VWR, VWT, WPL
NMEA 2000	: To be determined in future software release
USB on rear panel	: USB A type (USB 2.0 480mbs), USB stick
USB on front panel	: Micro-AB USB, USB stick (an adapter is required, for indoor use only)
Ethernet	: one port, up to 100 Mbps. LAN support.
Video Input	: 1 input, NTSC or PAL
Line Out	: 4VRMS (max) at 20K OHM
Wi-Fi® Antenna	: 802.11b/g/n external SMA connector

DIMENSIONS

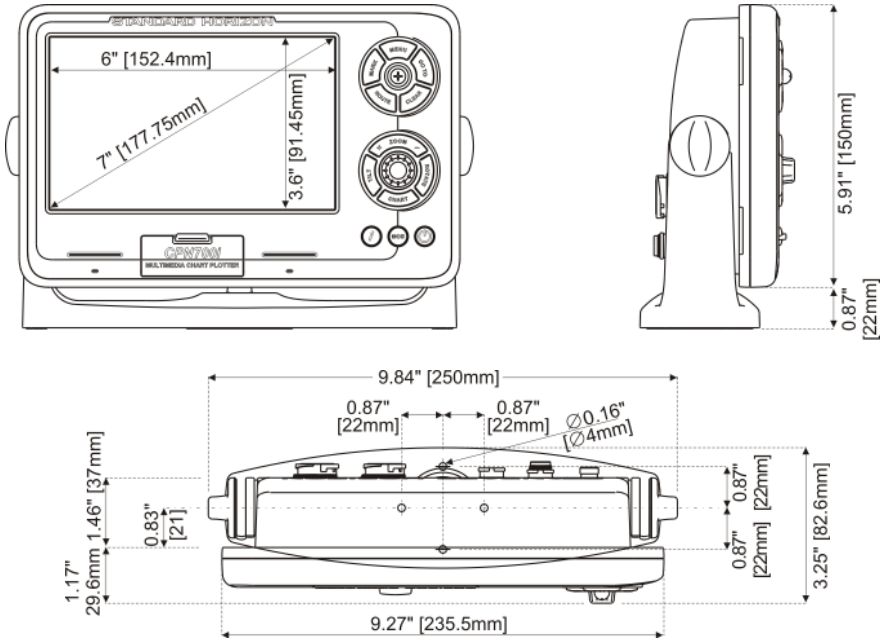

CPN1010i

Power Supply	: 12-24 VDC
Power Consumption	: 19W max Current Draw: 1.6A@12VDC
Display	: 10" Wide SVGA Resolution: 1024 x 600 Sunlight viewable Backlight: LED (1000nits) Touch screen: Capacitive
Cartography	: C-MAP 4D SD CARD
Operating temperature range	: 32°F/+131°F (0°C/+55°C)
Storage temperature	: -4°F/+158°F (-20°C/+70°C)
Keyboard	: Silicon rubber, LED backlight
Weight (without bracket)	: 4.4 lbs (2000 gr)
User Points (Marks/Waypoints)	: 10000
Routes	: 50
Track Points	: 10000 (recordable in 20 Tracks)

- NMEA 0183 Output sentences** : GLL, VTG, BWC, WCV, APA, APB, HDG, BOD, XTE, RMA, RMB, RMC, GGA, HSC, DBT, DPT, MTW, VHW.
- NMEA 0183 Input sentences** : BWC, DBT, DPT, DSC, DSE, GGA, GLL, GSA, GSV, HDG, HDM, HDT, MTW, MWD, MWV, RMC, RTE, TLL, VDM, VHW, VTG, VWR, VWT, WPL
- NMEA 2000** : To be determined in future software release
- USB on rear panel : USB A type (USB 2.0 480mbs), USB stick
- USB on front panel : Micro-AB USB, USB stick (an adapter is required, for indoor use only)
- Ethernet : one port, up to 100 Mbps. LAN support.
- Video Input : 2 inputs, NTSC or PAL
- Video Output : 1 output, VGA signals, 1024x600 resolution
- Line Out : 4VRMS (max) at 20K OHM
- Wi-Fi®** Antenna : 802.11b/g/n external SMA connector

DIMENSIONS

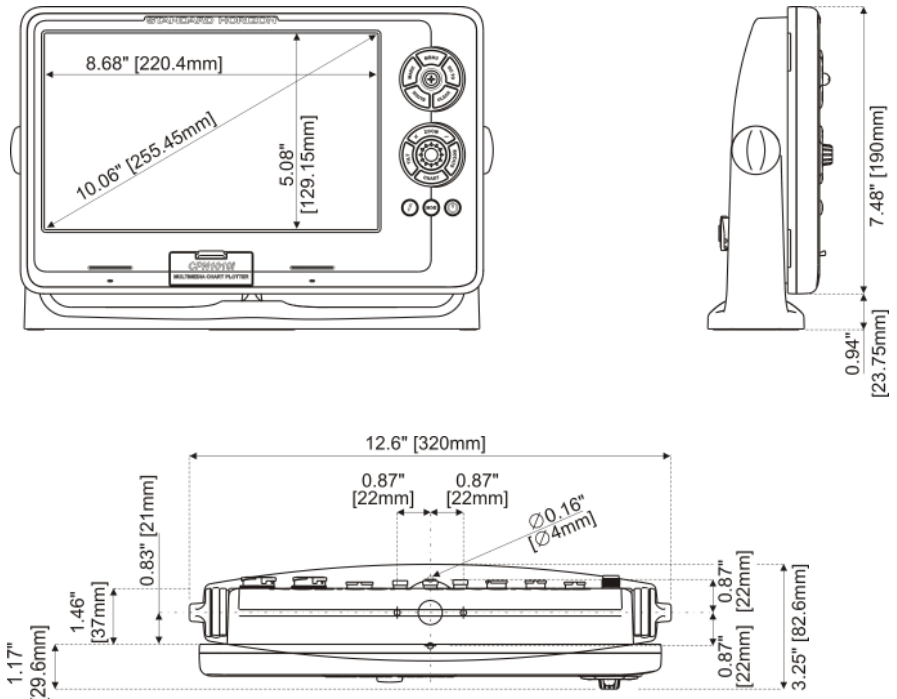

OPTIONAL FF525 FISH FINDER

- Power Output : 600W or 1kW depending on connected transducer
- Frequency : 50 and 200kHz
- Minimum Depth : 5Feet at 50kHz, 2.5Feet at 200kHz
- Maximum Depth : 1500Feet at 50kHz, 700Feet at 200kHz
- Airmar X-DUCER ID : Must use Standard Horizon transducers part numbers
- Advanced Digital Signal Processing
- Speed & Temperature Sensor (if available on transducer)
- Alarms (shallow water, depth, Fish, temp)
- Trip Log, Fish Symbols
- STC, Interference Rejection, Automatic noise reduction
- A-Scope, White Line, Zoom x2/x4
- Auto range/gain/frequency/shift/ping rate
- 16/256 colors display user selectable

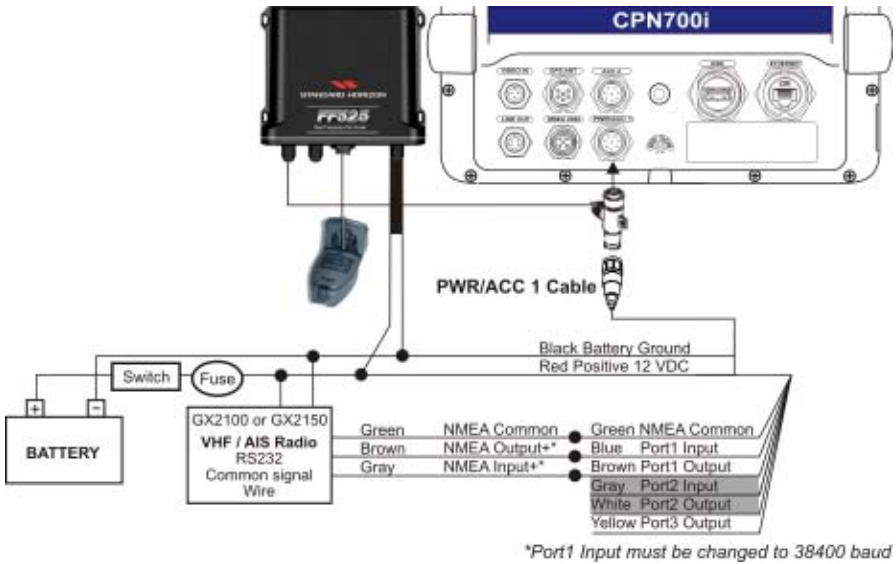

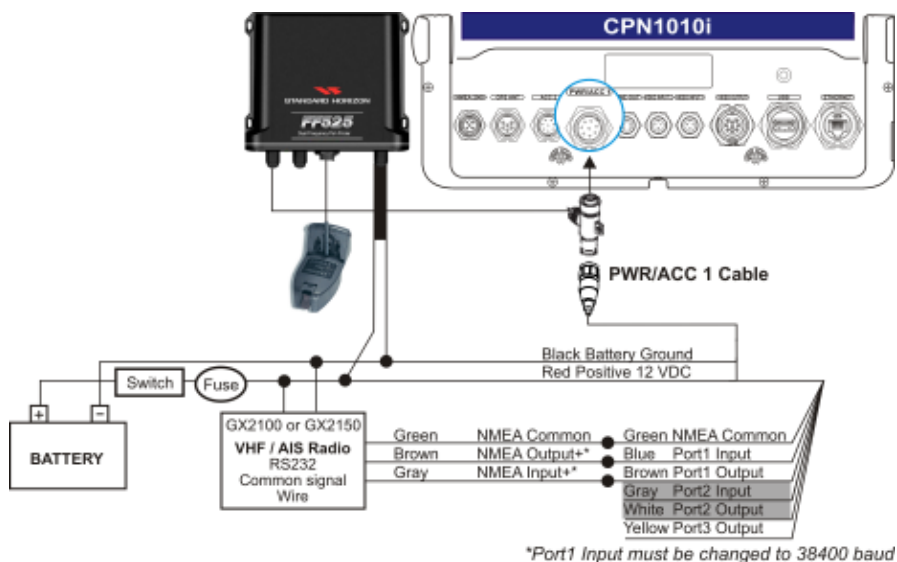

OPTIONAL WAAS GPS RECEIVER

This optional WAAS GPS Receiver is based on a ultimate GPS engine that delivers accuracy better than 10 Feet by decoding the GPS correction signals from the satellite-based WAAS (*Wide Area Augmentation System*). The GPS engine, interface electronics and the passive antenna are enclosed inside the waterproof plastic housing. This provides advanced state of the art GPS performance in an easy to use package.

Physical Characteristics

Color	Ivory white
Dimensions	97mm in diameter x 32mm in height (flush mounted) or 61,5mm on flag-pole mount
Weight (without cable)	0.35 lb (160 g)
Cable	white 15 meter 8x28AWG cable with 6 pins female connector

Electrical Characteristics

Input Voltage	10 VDC to 35 VDC unregulated	
Input Current	0.8 Wmax	
GPS Receiver Sensitivity	Tracking, Navigation	:-160 dBm
	Acquisition, Reacquisition	:-160 dBm
	Cold Starts	:-145 dBm

GPS Performance

GNSS Systems	GPS	: L1 C/A
	GALILEO	: L1
	SBAS	: WAAS (North America), EGNOS (Europe), MSAS (Asia), GAGAN (Indian)

Geodetic Datum WGS84

Channels 32 + 18

Acquisition Time

Reacquisition < 1 second

Hot Start 1 second

Warm Start 29 seconds

Cold Start 29 seconds

Accuracy

GPS < 10 Feet

with SBAS < 2.0m

NMEA Output

Messages GGA, RMC, GSA, GSV, TXT

GPS CONNECTION IMAGE

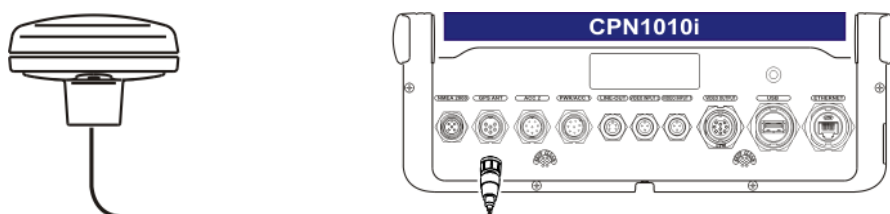
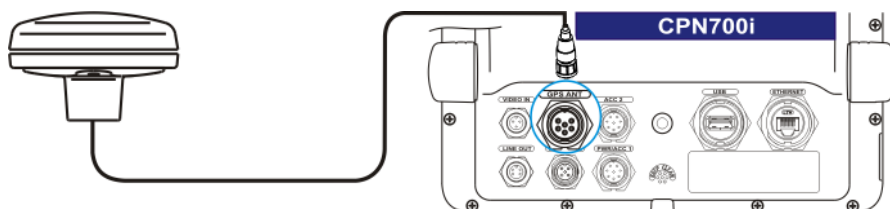



TECHNICAL TESTS

SYSTEM TEST

If you have connected your CPN Series Chart Plotter according to the instructions, and chosen the proper menu selection for your device, and are still having problems with your CPN Series Chart Plotter, the extended auto-test should help determine the problem. To enter the System Test it is needed to hold any key while the Chart Plotter application is starting:

1. Select the Start Up page.

2. Tap on the Plotter Icon  , when the STANDARD HORIZON sunrise page is shown, press and hold the  key until the System Test display is shown, then let go of the  key. A new menu will appear on the display:



Choose the test and tap on it. To exit from the System Test choose **EXIT** option.



RAM MENU (RESET)

 After performing a RAM Clear all Marks, Routes and tracks will be erased.

RAM Clear

All the internal memory can be erased and the default setting restored. If the CPN Series Chart Plotter exhibits unusual operations, or appears to be malfunctioning, it may be possible to correct the problem by clearing RAM.

This operation will erase all Marks, Routes, stored Track plots and Destinations. It will also return all selections (Input Data Format, Autopilot selection, etc.) to original default values.

To confirm clear RAM press the  (but if at this time you do not wish to clear RAM press the  key).

BACKLIGHT

Each time you move the  ShuttlePoint Knob to left, the screen will decrease brightness, move it to the right to increase brightness.

CARTRIDGES (USED BY STANDARD HORIZON TECHNICIANS)

Internal Data Base Test

To test the Worldwide Background.

SD CARD Test

To test the SD CARD. There are the possible situations:

1. if there is a SD CARD inserted in the slot and there is not a malfunction, the name of the SD CARD zone and the message "OK" are shown.
2. if there is a SD CARD inserted in the slot, but it is a defective SD CARD, the name of the SD CARD zone and the message "Faulty" are shown.
3. if there is not any SD CARD inserted in the slot, the message "not present" is shown.



SERIAL PORTS (USED BY STANDARD HORIZON TECHNICIANS)

If you are having problems receiving data from the position-finding instrument, this test should help determine the problem.

Change Parameters

To change the parameters of the serial interface. This menu allows to select the **Port** (Signal Source) between PORT 1, PORT 2, PORT 3, PORT 4, PORT 5; the **Baud Rate** between 300, 1200, 2400, 4800, 9600, 38400, 115200; the **Data Bits** (Word Length) between 7 or 8, the **Parity** between even, odd or none, the **Stop Bits** between 1 or 2. Default settings are: Port = PORT 2, Baud Rate = 4800, Data Bits = 8, Parity = none, Stop Bits = 1.

Input Data Display

To allow the CPN Series Chart Plotter to act as a computer terminal and display the incoming data exactly as it is received. If the data displayed on the screen is unrecognizable, you may have selected the wrong input parameters for your particular receiver, for example, Baud Rate 9600 instead of Baud Rate 4800. Check your receiver manual to be sure that you have selected the proper parameter. If the screen is blank, you may have a broken connection, and no data is being received or you may have connected the device to the other input port. Use the  key to stop (or continue after pause) data displaying, press the  ShuttlePoint Knob to show data in hex or ASCII mode (normal or small) and the  key to exit.

Loop-Back Test

This is a special test done during the production phase to check the serial ports integrity. A special connector is required.



SYSTEM UPDATE

SYSTEM UPDATE PROCEDURE

After downloading the Installation Package or contacting your dealer to obtain the proper Installation Package, follow the procedure below to update the system:

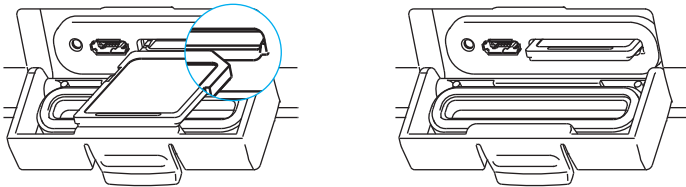
1. Install the Installation Package on a SD CARD.
2. Press the  PWR key to turn the CPN Series Chart Plotter Off.
3. Insert the SD CARD into the slot.



4. Press and hold the  PWR key to turn the CPN Series Chart Plotter On.
5. The Operating System (OS) installation starts. When completed, the CPN Series Chart Plotter automatically restarts.
6. The package update window appears (see A).
The CPN Series Chart Plotter checks the integrity of the Installation Package present on the SD CARD. This operation might require several minutes (if you want to abort the installation tap on ).

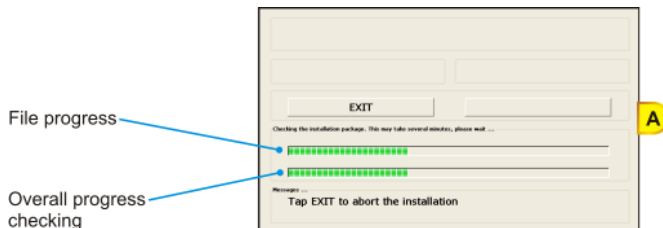

At the end of the checking, the package update window shows the following data (see B):

Installation Package Description

Version present on CPN series Chart Plotter before installation

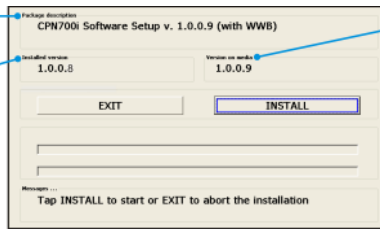

Version on SD CARD

The **INSTALL** touchscreen key is now selected (it appears with blue frame).

7. Tap on **INSTALL** to start installation (or tap on **EXIT** to abort).

⚠ Otherwise move the **+** ShuttlePoint Knob to place cursor on **INSTALL** (or on **EXIT** to abort) and then press the **+** ShuttlePoint or **●** Rotary Knob.

8. The installation process begins.

Pay attention: do not turn the CPN Series Chart Plotter Off during installation.

The installation status appears in the two progress bars on the bottom of the package update window (see C):

File progress

Overall progress installation

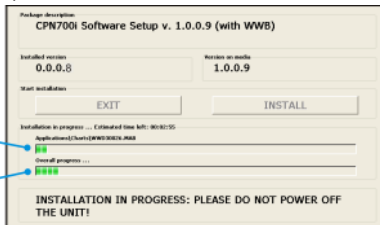

9. At the end of the installation process, the Start Up Screen is shown.

10. To complete the update system procedure, press the **⏻** PWR key to turn the CPN Series Chart Plotter Off and remove the SD CARD from the slot.

11. Then press and hold the **⏻** PWR key to turn the CPN Series Chart Plotter On: the system is now updated and ready to use.

SYSTEM UPDATE ERROR MESSAGES

Below there is the list of the error messages that can occur while updating system with the relative explanation and problem solving procedure.

ERROR MESSAGES 01, 02, 03, 04, 05, 06, 07, 09

- **Error 01 - INFO.DAT file not found**
The file info.dat was not found on the memory device
- **Error 02 - INFO.DAT file corrupted**
The file info.dat on the memory device is corrupted

• **Error 03**

ATTENZIONE: file di aggiornamento non valido per questo dispositivo

WARNING: wrong update file

ATTENTION: fichier de mise à jour non compatible avec ce dispositif

WARNUNG: falsche Updateakte

CUIDADO: ficheros de actualización no válidos para este dispositivo

ATENÇÃO: dados de atualização não válidos para este dispositivo

The Installation Package on the memory device is not suitable for the CPN Series Chart Plotter

• **Error 04 - Update File corrupted**

The Installation Package files on the memory device are corrupted

• **Error 05 - Xloader wrong file size**

The Installation Package files on the memory device are corrupted

• **Error 06 - Boot wrong file size**

The Installation Package files on the memory device are corrupted

• **Error 07 - OS wrong file size**

The Installation Package files on the memory device are corrupted

• **Error 09 - Cannot find any component to update**

The Installation Package does not contain all the required files

If one of the these messages appears, press the  PWR key to turn Off the CPN Series Chart Plotter and then follow the procedure:

1. Download the Installation Package again and install it on the SD CARD (or contact your dealer to obtain the proper Installation Package).
2. Repeat the installation procedure.

ERROR MESSAGE 08

• **Error 08 - SD card not recognized**

The CPN Series Chart Plotter does not recognizes the SD CARD in the slot or the SD CARD slot is damaged

If this message appears, press the  PWR key to turn Off the CPN Series Chart Plotter and then follow the procedure:

1. Download the Installation Package again and install it on a different SD CARD (or contact your dealer to obtain the proper Installation Package).
2. Repeat the installation procedure.
3. If the problem persists, contact your dealer to check the SD CARD slot on the CPN Series Chart Plotter.

ERROR MESSAGES 20, 21, 22

• **Error 20 - Update SD card not present: System Halted**

The Operating System is not installed in the CPN Series Chart Plotter and no Installation Package SD CARD inserted

• **Error 21 - UPLOAD Folder not found: System Halted**

The Operating System is not installed in the CPN Series Chart Plotter and the inserted SD CARD does not contain a valid Installation Package

• **Error 22' - OS Image Corrupted: System Halted**

The Operating System in the CPN Series Chart Plotter is corrupted

 It might occur when the Operating System gets corrupted (for any reasons regardless of installation procedure).

If one of these messages appears, press the  PWR key to turn Off the CPN Series Chart Plotter and then follow the procedure:

1. Download the Installation Package and install it on the SD CARD (or contact your dealer to obtain the proper Installation Package).
2. Execute the installation procedure.

TERMS

- AES** (*Advanced Encryption Standard*) – Is the **Wi-Fi®** authorized strong encryption standard. It uses a Pre-Shared Key (PSK) that is 8 or more characters in length, up to a maximum of 63 characters.
- ALT** (*Altitude*) – Shows the Altitude of the GPS Antenna on the mean sea level. It is received from GPS, sentence GGA.
- APP Wind DIR** (*Apparent Wind Direction*) – Shows the Apparent Wind Direction when an external wind instrument with NMEA is connected.
- APP Wind SPD** (*Apparent Wind Speed*) – Shows the Apparent Wind Speed when an external wind instrument with NMEA is connected.
- BRG** (*Bearing*) – The direction from your current position to a Destination point.
- COG** (*Course Over Ground*) – The course your vessel is heading.
- DATE** – Shows the current date received by the GPS.
- DEPTH** – Shows the water depth when the optional FF525 50/200kHz BLACK BOX FISH FINDER or Digital Depth Sounder is connected.
- DEPTH AREAS** – Depth Areas are the sea areas included in the user selectable range of minimum and maximum depth limits.
- DRAUGHT** – Depth of water the vessel draws. The definition of **draught** (or **draft**) of a ship's hull is the vertical distance between the waterline and the bottom of the hull (keel). Draught determines the minimum depth of water a ship or boat can safely navigate. On the Tide page the **draught** window shows the height of the tidal water during a 24hr period of time. This height is dependant on the time of day.
- DSC** (*Digital Selective Calling*) – Digital Selective Calling is a semi-automated method of establishing a VHF Radio call. DSC had also been designated as part of the Global Maritime Distress and Safety System (GMDSS). It is planned that DSC will eventually replace aural watches on distress frequencies and will be used to announce routine and urgent maritime safety information broadcasts.
- DST** (*Distance*) – The distance from your current position to a Destination point.
- ETA** – Estimated Time of Arrival
- GPS Constellation** – The Global Positioning System (GPS) is a space-based radio-navigation system consisting of a constellation of satellites and a network of ground stations used for monitoring and control. A minimum of 24 GPS satellites orbit the earth at an altitude of approximately 11,000 miles providing users with accurate information on position, velocity and time anywhere in the world and in all weather conditions.
- GPS2D** – The GPS is receiving at least 3 valid satellites.
- GPS3D** – The GPS is receiving at least 4 Satellites.
- HDG** (*Heading*) – Shows heading from an External Flux Gate Compass when connected.
- HDOP/VDOP** (*Horizontal/Vertical Dilution of Precision*) – It is a parameter indicating the precision of the positioning system (GPS). The smaller the HDOP/VDOP value, the more accurately the position fix is provided.
- HEIGHT** – The current Tide Height referred to the vertical cursor.
- HIGH WATER** – The maximum level of the tide height in 24 hours.
- LOW WATER** – The minimum level of the tide height in 24 hours.

PINGO – It is a mound of earth-covered ice found in the Arctic and subarctic that can reach up to 70 metres (230FT) in Height and up to 600 metres (2.000 FT) in diameter.

Position Request – Marine DSC VHF Function of transmitting a GPS position to another Marine DSC VHF. When CPN Series Chart Plotter is connected to STANDARD HORIZON GPS the position of another vessel is shown on the Chart Page.

Raster Chart – Representation of the drawing through a collection of points describing color information, without any other kind of enrichment (usually it is the result of a scanning process).

SPEED – Shows the Speed Thru the Water when a Digital Speed Log is connected.

SOG (*Speed Over Ground*) – The speed you vessel is travelling at.

STEER – Heading to steer to destination Waypoint.

TIME – Shows the current time received by the GPS.

TKIP (*Temporal Key Integrity Protocol*) – is an encryption method. TKIP provides per-packet key mixing a message integrity and re-keying mechanism. It uses a Pre-Shared Key (PSK) that is 8 or more characters in length, up to a maximum of 63 characters.

TRIP LOG – Shows the distance the vessel has travelled since the trip log was reset.

TRU Wind DIR (*True Wind Direction*) – Shows the True Wind Direction when an external wind instrument with NMEA is connected.

TRU Wind SPD (*True Wind Speed*) – Shows the True Wind Speed when an external wind instrument with NMEA is connected.

TTG (*Time To Go*) – Shows time to go to reach a Destination point.

UNITS

Nm Nautical Mile (1 NM = 1.15 Sm or 1.85Km)

Sm Statue Mile (1Sm = 0.87Nm or 1.61Km)

Km Kilometer (1 Kilometer = 0062 Sm or 0.54Nm)

FT Feet (1 Foot = 0.167 Fathoms or 0.305 Meters)

FA Fathom (1 Fathom = 6 Feet or 1.83 Meters)

Mt Meter (1 Meter = 3.28 Feet or 0.55 Fathoms)

Kts Knot (1 Knot = 1.15 MPH or 1.85 KPH)

MPH Miles Per Hour (1 MPH = 0.87 Knots or 1.61 KPH)

Kmh Kilometer Per Hour (1 KPH = 0.54 Knots or 0.62 MPH)

Vector-based Chart – A set of structured information concerning with shapes, lines, points, areas, Routes and it is enriched with several kinds of attributes and information. This approach permits to access to the chart not only as a static visualization of a drawing but also to manage the information, and the attributes that it contains, working as a Geographic Information System, that is a kind of geographic database.

VMG – It is the destination closing Velocity. The VMG is calculated using the current speed of the vessel (SOG) and the difference between the current vessel course and the bearing to the Destination.

WAAS 2D/3D – The GPS is receiving a 2D or 3D position and the correction from the WAAS Satellite. WAAS consists of approximately 25 ground reference stations positioned across the United States that monitor GPS satellite data. Two master stations, located on either coast, collect data from the reference stations and create a GPS correction message. This correction accounts for GPS satellite orbit and clock drift plus signal delays caused by the atmosphere and ionosphere. The corrected differential message is then broadcast through one of two gestational satellites, or satellites with a fixed position over the equator. The information is compatible with the basic GPS signal structure, which means any WAAS-enabled GPS receiver can read the signal.

WATER TEMP – Shows the sea water temperature when the FF525 50/200kHz BLACK BOX FISH FINDER or a Digital Speed Log/Temp instrument with NMEA is connected.

WEP (*Wired Equivalent Privacy*) – Open System authentication: the WLAN client need not provide its credentials to the Access Point during authentication. Thus, any client, regardless of its WEP keys, can authenticate itself with the Access Point and then attempt to associate. After the authentication and association, WEP can be used for encrypting the data frames.

WPA (*Wi-Fi® Protected Access*) – Initial WPA version, to supply enhanced security over the older WEP protocol. Typically uses the TKIP encryption protocol.

WPA2 (*Wi-Fi® Protected Access II*) – Successor of WPA, replaces the TKIP encryption protocol with AES to provide additional security.

WPA-Personal (*Wi-Fi® Protected Access-Personal*) – Also referred to as WPA-PSK (Pre-shared key) mode. Is designed for home and small office networks and doesn't require an authentication server. Each wireless network device authenticates with the access point using the same 256-bit key.

XTE (*Cross Track Error*) – The distance your vessel is off course (left or right) to a Destination point.

ANALYTICAL INDEX

& HIGHWAY	83, 84, 92
1 Line Large	37, 86, 87
1 Line Small	37, 86, 87
1 Line Small/Large	85
2 Line Small	37, 85, 86
200kHz & CHART	96
2D	20, 25, 38, 41, 52, 62
2nd CPN	116
3 Dimensional Chart View	41
3D	20, 26, 40, 41, 52, 53, 62
3D Exaggeration Factor	53
3D View	10
4D	20, 38, 40, 41, 42, 51, 80, 115, 116, 119
4D charts	137
4D FUNCTIONS	51
50kHz & CHART	96
A	
ABOUT	38, 42, 80, 105, 119
About Page	42, 80, 105, 119
ACC 2	138, 139, 140
ACCURACY	70
ACQUIRING	93
ACTIVATE VIDEO	100
activating Soft Keys	16
Activation Range	108
Active Target	108
ACTIVE TRACK	78
ACVC10	143
adjust backlight	100
adjust hue phase	100
adjust saturation colors	100
ADVANCED	101, 105, 141
Advanced Setup menu	101
AES	114, 160
AIS	10, 82, 102, 107, 108, 109
AIS List	11, 109
AIS Receiver	137
AIS SETUP	108
AIS Target	108
AIS TARGET COLORS	109
Alarm	107
alarm conditions	69
Alarm Report	104
ALARMS	103
Alaska	10, 37
ALT	85
Alternate Solution	102
Altitude	36, 85, 160
Anchor Alarm	103
antenna	10
APA	103, 148, 150
APB	103, 148, 150
Apparent Wind Direction	85, 160
Apparent Wind Speed	85, 160
Arrival Alarm	103
ASF1/2	101
assistance	10
Attention Areas	88, 89
Audible Alarm	103
audio	10
Audio Amplifier	137
Authentication	114
AUTO	96

AUTO INFO	37, 88
Auto Info	105
Auto Position	105
AUTOMATIC CHECK	69
Automatic Identification System	107
Autopilots	137
AWD	85
AWS	85
B	
background	128
background colors	36
BACKLIGHT	155
backlight	10, 14
backup	64, 79
Bahamas	10, 37
Bathy charts	42
BATTERY CONNECTIONS	138
Battery Connections	137, 157, 158
Beacons	57, 89
Bearing	25, 37, 95, 160
Bearing (BRG)	74
Bearing to Destination	85
Bearings	102
beep	36
Bluetooth	10, 13
BMP	128
BOD	103, 148, 150
Boundaries Mode	88, 90
bracket installation	133
Bracket Mounting	133
BRG	25, 85, 92, 95, 160
Brightness	21
brightness	15
BROWSER	120
Browser	21
Built-In cartography	20
BUILT-IN CHARTS	37
Built-In Charts	10, 37, 106
built-in Simulator	104
Buoys	57, 87, 89
BWC	103, 114, 148, 150
C	
C-MAP 4D	10, 15, 20, 40, 41, 104, 147, 148, 149
C-MAP 4D CARD	115
C-MAP 4D SD CARD	104
C-Marina port Database	41
Calibration	102
Canada	10, 37
Caribbean	10, 37
cartographic objects	88
Cartography	148
cartography	10, 15
Category	49
category	42
Caution page	24
Central America	10, 37
Chain	33, 101
change a page	26, 29, 99
Change Parameters	155
change the fields	19
change the SD CARD	81
Changing Pages	29, 31
Changing the day	45

Changing Tide station	45	Current Time	85
CHART	84	CURRENTS	89
Chart	82, 83, 105	CURSORS	74
Chart Boundaries	88, 90	Cursor	28
Chart Configurations	88	cursor	14
CHART CONTROL ICON	37	Cursor Control	104
Chart Control Icon	35	Cursor Mode	25, 37, 74, 85
Chart Datum	101	CURSORSPEED	28, 36
Chart Display	26, 51	CURSOR WINDOW	37
CHART DISPLAY menu	21	Cursor window	25
Chart functions	51, 82	Custom	88
CHART Key	15	customize the display	36
Chart Language	56	CUSTOMIZING A PAGE ICON	83
Chart Lock	88, 91	D	
Chart Mode	20	DAM	106
Chart Orientation Resolution	101	DAM Report Page	106
CHART PAGE	83	dangerous objects	69
Chart Page	25, 83	Dangerous Target	108
CHART PAGE WINDOW	37, 85	Danish	34
Chart Plotter	13	DATA	94, 95
Chart Plotter mode	13	Data Access Manager Report	105, 106
Chart Scale	85, 86	Data Boxes	86, 92
chart scale	20	data field	86
Chart Settings	90	data port	96
Chart Shading	52	Data Safety Indicator	54, 91
Chart Update Card	38, 39, 156	Data Window Selections	84
Chart Window	51	Data Windows	86
Chart/Highway Page	83, 92	Data/Features Segmentation	106
Chinese	34	DATE	85, 160
Classic	33, 36	Date	104
clean the glass	15	DATE FORMAT	36
cleaning	15	DAYLIGHT SAVINGS	32
Clear Info	40	Daylight Savings Time	31
CLEAR Key	14	DBT	103, 148, 150
Clear View	40	DELETE	78
Close window control	23	delete a saved file	81
Closest Point of Approach	107	DELETING A MARK	61
Closing Soft Keys	23	DELETING A MOB	76
Code and Name	106	DELETING A ROUTE	68
COG	85, 92, 95, 102, 160	Deleting a Track	78
COLOR	68	deleting all stored points	63
COMPASS	86, 91, 92, 102	deleting the selected point	63
Compass Indicator	58	Demo Mode	104
Compass Page	92	DEPTH	160
Compass Rose	11	Depth	36, 85, 103
connection	121	Depth Alarm	103
connection examples	141	DEPTH AREAS	160
Connection Manager	13, 121	Depth contours	37
Connection Manager icon	111, 116, 117	DEPTH LIMIT	69
CONNECTIONS	137	Depth Range Max	88, 90
connectors	137	Depth Range Min	88, 89, 90
CONVENTIONS	13	Depth Settings	89
Coordinate System	33, 101	Depth sounder	94
coordinates	64	Depths	41
copyright	105	Desktop Icons	82
Course	104	destination	19, 74
Course Over Ground	85, 95, 160	Detailed World Background	40
Course Time Line	57	DEVICES REMOVAL	23
Course Up	29, 57	Diagram	58
Course Up/North Up	29, 56	Diagrams	41
Coverage	37	DIFF CORRECTION SOURCE	94
CPA	107	Differential Correction Source	94
CPA Alarm	107, 108	Diffusers	69, 89, 91
CPA Limit	107, 108	Digital Instruments	137
CPN1010i	10, 144	Digital Raster Chart	41
CPN700i	10, 143, 148	Digital Selective Calling	97, 160
CREATING A ROUTE	65, 67	DIMENSIONS	149, 150
Cross Track Error	85, 162	DISPLAY	51, 52, 53, 54, 56, 57, 58, 94
Cuba	10, 37	Display	10, 108, 148, 149
Current Date	85	DISPLAY COLOR	36

Display Color	33
Display Mode	51
DISTANCE	78
Distance	25, 36, 37, 160
Distance (DST)	74
distance (track)	77
Distance to Destination	85
Distress Call	98
DIVX	128
DPT	103, 148, 150
DRAUGHT	160
draught	71
draught (Tide)	45
Dredged Areas	69
DSC	11, 70, 97, 98, 105, 160
DSC DIR	99
DSC Directory	99
DSC Distress	11
DSC function	105
DSC LOG	98
DSC POLLING	105
DSC position	98, 99
DSC VHF	98, 161
DSC VHF radio	11
DSC VHF radios	97
DSE	148, 150
DSI	54, 91
DST	25, 85, 160
DTP	85
DUAL	83, 84, 96
Dual Chart	27, 51, 111, 120, 121, 128, 129
Dual Chart Page	83
Dual chart window	11
Dutch	34
DVD	143
Dynamic Currents	41
E	
EASY ROUTING	70
Easy Routing	10, 41
EDIT	68
Edit	20
edit	62
Edit Route	65, 68
EDITING A MARK	60
Encryption	114
English	34
Enhanced Mixing Levels	41
ER	70
Error 01	157
Error 02	157
Error 03	158
Error 04	158
Error 05	158
Error 06	158
Error 07	158
Error 08	158
Error 09	158
Error 20	158
Error 21	158
Error 22	158
Estimated Time of Arrival	85
ETA	85, 160
ETHERNET	147
Ethernet	13
Ethernet Cable	115
Ethernet Radar	137
Expiration Date	106
EXTERNAL ALARM	146
External Alarm	103, 137
External Antenna	93, 116

external device	63, 95
-----------------------	--------

F

FA	161
Fathom	161
FAVORITE PAGE	125
features	10
Feet	161
FF525	10, 102, 103, 137, 146, 160, 161
FIND	43, 44, 45, 46, 47, 48, 49, 50, 83, 96
find a point by name	62
FIND SERVICES	43
Find Services & More	43, 83
Find Tide Stations	97
Finnish	34
firmware update	105
FISH FINDER	103, 137, 146, 151
Fish Finder	10, 82, 86, 105, 141
Fishing Facility	69
fix	25
Fix coordinates	33
fix position	25
Flick	16
flush mount	134
FLUSH MOUNTING	134
flush mounting	133
Flux gate compass	94
focus	84
FORMATTING	80
French	34
Fresh water	10, 37
Front panel stereo	10
FT	161
fuel	68
Full	88
FULL 200kHz	96
Full 4D	40
FULL 4D Content	41
FULL 50kHz	96
Full Info	59
Full Screen View	100
Full Screen View 1	100
Full Screen View 2	100
fuse	138
G	
General	37, 85, 87
General Setup	36
German	34
GETTING STARTED	24
GGA	103, 148, 150, 160
GIF	128
GLL	103, 148, 150
Global Positioning System	160
GOTO	19, 72
GOTO A ROUTE	74
GOTO CURSOR	73
GOTO Key	14
GOTO MARK	75
GOTO popup window	74
GPS	10, 25, 31, 91, 93, 133, 153, 160
GPS ANTENNA	146
GPS Antenna	133, 137, 160
GPS Auto	102, 140
GPS Constellation	160
GPS Source	93
GPS STATUS	86
GPS Status	92
GPS Status Page	25, 93
GPS2D	93, 160
GPS3D	93, 160
Great Lakes	10, 37

Greek	34
Grounding Alarm Range	103
Grounding Alarm Report	103, 104
GSA	103, 148, 150
GSV	103, 148, 150
Guardian Alarm	38, 41
H	
Hawaii	10, 37
HDG	85, 103, 148, 150, 160
HDM	148, 150
HDOP	85
HDOP/VDOP	160
HDT	148, 150
Heading	160
Heading from Electronic Compass	85
HEIGHT	160
height	71
HG	148, 150
HIDE	62, 64
HIGH WATER	160
HIGHWAY	86, 91
Highway Page	57, 74, 86, 91
HISTORY LIST	124
Hold	16
Home Mode	20, 25, 37, 74, 85, 101
HOME MODE RETURN	37
Home Mode Return	23, 26, 74
Home page	121
Horizontal Dilution of Precision	85
Hot spots	112
HSC	103, 148, 150
hue phase	100
Human Dictionary	40
Hydrographic Offices	40
I	
ICON	36, 62, 64
icon	62
Icon Points	87
Icon Size	53
Information	50, 87
Information Window	18
INITIAL SETUP	28
Input Data Display	155
Input/Output	102
INSERTING A WAYPOINT	67
Intelligent Key	15
Intelligent key	21, 22, 121, 129, 131
Internal Antenna	93, 116
Internal Data Base Test	155
Internet Browser	13, 21
Internet Explorer	10, 120
Internet modes	13
Intertidal Areas	69
IP57 waterproof	10
ISO 9001	40
ISO Certification	40
Italian	34
J	
Japanese	34
joystick	20
K	
Keyboard	16, 148, 149
keyboard	10
KEYPAD BEEP	36
KEYS	19
Keys	16
Kilometer	161
Kilometer Per Hour	161
Km	161
Kmh	161
Knot	161
Kts	161
L	
Lake name/info	40
Land Areas	68, 70, 73
Land Elevation	41
LANGUAGE	37
Language	34, 56
Lat/Lon Grid	88, 90
Latitude	90, 92
Latitude/Longitude	33, 63
License Page	105
license type	105
Lights	57, 87, 89
LINE COLOR	78
LIST	109
load the data	81
local area names	89
locate	62
Longitude	90, 92
Loop-Back Test	155
Loran	101
Loran TD	33, 101
Loran TDs	33
Lost Target	108
Low	88
LOW WATER	160
M	
Magnetic bearing	102
Magnetic Variation	102
Main Menu	
14, 19, 26, 27, 29, 82, 99, 100, 111, 120, 121, 128, 129	
MAN OVER BOARD	76
Man Over Board	21
Man Overboard Mark	15
marine features	89
Marine Settings	89
Mark	14, 20, 49, 60, 61, 62, 64, 67, 70, 79, 148
Mark Edit	60
Mark Icon	63
MARK Key	14
Mark Name	63
MARKS/WAYPOINTS	75
Marks/Waypoints List	60, 62
Marks/Waypoints page	75
Marks/Wpt List	20
MAX	40
MAX Content	41
MAX SPD	85
Max Speed	85
MEASURE DISTANCE	37
Media Player	13, 15
Medium	88
memory stick	10, 23
MENU DESCRIPTION	17
MENU Key	14
Meter	161
Mexico	10, 37
Miles Per Hour	161
MMSI	99, 107
MOB	70, 76
MOB Key	15
monitor	137
Mooring/Warping Facility	69
Mounting	133
mounting	136
mounting hole	135
Move	16
MOVING A MARK	61

moving cursor	16
MPH	161
Mt	161
MTW	103, 148, 150
Multi-language capability	41
Multimedia icon	120, 129
Multimedia Player	10
MWD	148, 150
MWV	148, 150
N	
name of ship	107
Nautical Mile	161
Nav Aids & Light Sectors	88, 89
Nav-Aids	38, 40, 57, 89
Nav-Aids Names	88, 89
Nav-Aids Presentation	57
NAVIGATE	103
Navigate menu	101
Navigation	82, 91
NAVIGATION PAGES	91
Navigation Speed	93
Network interfaces	10
Networked Chart	107
NEW MARK	60
New Mark	63
new software	79
Night	33, 36
Nm	161
NMEA	10, 63, 68, 82, 94, 95, 99, 102
NMEA 0183	94, 98, 107
NMEA 0183 CONNECTIONS	139
NMEA 0183 Devices	137
NMEA 0183 output	103
NMEA 2000	10, 137, 147, 148
NMEA DATA	86
NMEA Data Page	95
NMEA DATA PAGES	94
NMEA Display Page	94, 95
NMEA Input	148, 150
NMEA inputs	102
NMEA Output	148, 150
NMEA outputs	102
NMEA pages	94
NMEA0183	102, 140
NOAA	33, 36, 57
Normal	33, 36
North Up	29, 57
Norwegian	34
NTSC	10, 143, 144
O	
Object Info	40
Obstructions	40, 46, 69, 89, 91
Official data source	40
OLYMPIC ROUTE	66
Olympic Route	11
On All	87
On Points	87
Open/Close Data Windows	86
Operating System	158
OPTIONAL ACCESSORIES	12
optional devices	105
Outdoor Recreational Area	47
Overlay	52
P	
package	11
PACKING LIST	11
Page Change Key	22
Page Icons	82
Page Selection	82

Page Soft Keys	31
PAGE SWEEP	36
Page Sweeping	16
Pages Selection	29, 31
Pair	33, 101
Pan	16
pan	25
PANEL	14
PC	63, 68
PCMPA	148, 150
Perspective view	41
Photos	41
Pictures	58
pin ou	145
PINGO	161
Pingos	69
PiP image	100
PIP View	100
PIP View 1	100
PIP View 2	100
Place Name Size	54
Place Names	88, 89
Placing a cursor	16
PLACING A MOB	76
Plotter Icon	24, 119
PNG	128
POI	40, 41
Points Of Interest	41, 49
Port	44, 89
Port by Name	40
Port Info	38, 40
PORT Input selections	140
Port Names	88, 89
PORT Output sentences	141
Port Services	43
Ports & Services	88, 89
Portuguese	34
POSITION	85
Position Report	11
Position Request	98, 105, 161
Power boat	11, 29, 57
Power Key	15
Power supply	148, 149
POWER UP	13, 156
Powering Off	13
PRE-AMP OUTPUT	144
Product Support	10
Production Installation	69
Programmed Date	106
Property Status	106
Puerto Rico	10, 37
PWR key	21
PWR/ACC1	138, 139, 140
Q	
QUICK INFO	108
Quick Info	40, 48
Quick swipe	25
quick zoom	20
R	
Radar	10, 88
Radio Call Sign	107
RAM Clear	154
RAM Menu	154
Raster	41
Raster Charts	10, 52
raster charts	115
RECEIVE	63, 68
receives points	63
Release Date	106
remove the cartridge	80

remove the SD CARD	42
REMOVING A SD CARD	42
replacement parts	11
reset	154
reset the log	79
reset the Track	78
reset the Trip Log	79
RESPECT DRAUGHT	71
Restart GPS	93
REVERSE	68
RM	148, 150
RMA	103, 148, 150
RMB	103, 148, 150
RMC	103, 148, 150
road mapping	41
Rocks	69, 89, 91
Rotary Knob	15, 20, 82
ROTATE Key	15
rotate the chart	20
Route	14, 20, 41, 60, 64, 65, 66, 67, 68, 70, 79, 104, 148
Route Check	68
Route Check menu	69
ROUTE CHECK REPORT	70
Route checking	11
ROUTE Key	14
Route legs	69
ROUTE MENU	68
Route name	66
ROUTE WIDTH	69
Routes	74, 149
RS232	102
RTE	63, 68, 148, 150
Russian	34
S	
SAFE CORRIDOR	71
SAFE DEPTH	71
Safe Depth	88
SAFE HEIGHT	71
SAFE MARGIN	71
Safe Route Check	41
Safety Remove Data Cartridge	105
Safety Status Bar	41, 54
Sail boat	11, 29, 57
Satellite	52
satellite	40, 115
Satellite Images	10, 41
Satellites	102
satellites	25, 31
saturation colors	100
save the file	81
SC	148, 150
SCALE	85
scale	14
Scrolling maps	16
SD	79
SD CARD	23, 42, 58, 64, 79, 80, 90, 107, 148, 149, 155
SD card slot	15
Seabed Type	88, 89
Search & Find	40
Second CPN	93
Segmentation	107
SELECT	68
Select Route	71
SELECT ROUTE window	75
SELECTING A ITEM	18
Selecting Language	34
SEND	63, 68
Send	63
Serial Ports	155
Setup Menu	27, 82, 93
Shallow Water	68, 69
SHIP ICON	29
Ship Icon	11, 25, 28, 57
Ship Icons	11
Shoreline Constructions	69
SHOW	62, 64
Shut Down	13
ShuttlePoint Knob	14, 20, 82
Si-Tex/Koden Radar	10
Signals	57, 89
SIMULATION	104, 105
Simulation Mode	104
SINGLE	83, 84
Single Chart	51
Single tap	25
Sleeping Target	108
slot	39, 156
Sm	161
SOFT KEYS	22
Soft Keys	31
Software	105
software	11, 79
SOG	85, 161
sorting by icon type	62
sorting the name of User Points	62
Spanish	34
SPD	85
speakers	137
SPEED	105, 161
Speed	36, 85, 104
speed	28, 68
Speed Filter	93
Speed Log	94
Speed Over Ground	85, 161
Splash Screen	13, 24
Spot Soundings	37, 42
START EASY ROUTING	71
Start Up	13, 15, 24, 111, 120, 128, 154
Starting Waypoint	65
Statue Mile	161
STEER	161
Steering	85
STEP UNIT	78
stereo	10
stop navigating	19
stop navigating to the MOB	76
Stop navigation	74
STR	85
Subscription Status	106
Sunlight	33
Sunlight viewable	10
Swedish	34
Sweep	30
Swipe	25
SYSTEM TEST	154
T	
Tap	16
Target	107
Targets AIS	11
TCPA	107
TCPA Alarm	107, 108
TCPA Limit	107, 108
TD	33, 101
technical support	10
TEMP	85
Temperature	36
temperature	148, 149
TERMS	160

TEST	154	Universal Time Coordinates	31
THICKNESS	68	update the charts	38
thumb	131	USB	10, 23, 145
TIDE	96	USB memory stick	137
Tide	45, 82, 96, 99	USB thumb drive	131
tide	160	User Point	60
Tide Graph	45	User Points	49, 80, 82, 148, 149
Tide height	45	UTC	31
Tide icons	56, 89	UTM	33, 101
Tide information	96	V	
TIDE PAGE	96	VAD	42, 91
Tide Page	38	VAD Boundaries	88, 91
Tide page	32, 96	VAD Menu	42
Tide Prediction time	45, 97	Value Added Data	10, 40, 42, 91
Tide Station	40	Variation	102
Tide Stations	41, 45, 87, 97	VCR	143
Tides	88, 89, 96	VDM	148, 150
Tides & Currents	88, 89	VDOP	85, 93, 160
Tides Preview	41	Vector	52
TILT Key	15	Vector Chart Sharing	115, 116, 118
tilt the chart	21	vectorial chart	53
TIME	78, 85, 161	Velocity Made Good	85
Time	104	Vertical Dilution of Precision	85
time (track)	77	vessel	25
Time Difference	101	Vessel Draft value	45, 97
TIME FORMAT	32	Vessel Name	99
TIME SETUP	32, 36	vessel's position	25
Time Setup	31, 45	VGA	144
Time to Closest Point of Approach	107	VGA input	137
Time To Go	85, 161	VGAC10	144
TIME ZONE	32	VHF frequencies	107
time zone	32	VHF Marine Radios	97
Time Zone offset	36	VHF Radio	95, 141
TIMEOUT	71	VHF radio call	97
TKIP	114, 161	VHF/AIS Radio Connections	143
TLL	148, 150	VHFs	137
TLOG	85	VHW	103, 148, 150
TOUCHSCREEN	15	VIDEO	99, 100
Touchscreen	14, 148	Video adjustment mode	100
Touchscreen Calibration	15, 19	Video Camera	137
Touchscreen Keyboard	16, 17	VIDEO INPUT	143
touchscreen keyboard	49, 50, 61, 62, 66, 105	Video Input	10, 82
Touchscreen Keys	16	VIDEO INPUT CONNECTIONS	143
Towers	87	VIDEO INPUT CONNECTOR	143
Track	79	Video Input menu	99
Track Points	77, 148, 149	VIDEO INPUT/OUTPUT	144
TRACKING	78, 85	VIEW ON CHART	105
Tracking	77, 85	VISIBLE	78
tracks	77	VMG	85, 161
Tracks & Routes	88, 89	VTG	103, 148, 150
Transparency	53	VWR	148, 150
TRIP LOG	78, 161	VWT	148, 150
Trip Log	85	W	
TRU Wind DIR	161	WAAS	102, 140, 152
True Wind Direction	85, 161	WAAS 2D/3D	93, 161
True Wind Speed	85, 161	WAAS GPS	10
True-Type Font	40	WAAS/EGNOS	93, 94
TTG	85, 161	WAAS/GPS	93
turn off	13, 117, 119	Warning Messages	72
TWD	85	Warning Status	107
Two Line Small	85	Warning Window	18, 74
TWS	85	WATER TEMP	161, 162
U		Water Temperature	85
Underwater Ob. Limit	89	waterproof	10
Underwater Object Limit	91	waterproof warranty	11
Underwater Objects Settings	91	WAV	128
UNIT ID code	38	Waypoint	14, 20, 41, 49, 60, 61, 62, 64, 65, 66, 68, 79, 148
UNITS	161	WCV	103, 148, 150
units	86	Weight	148, 149
UNITS OF MEASURE	36		

WEP	114, 162	WPA2-PSK	114
WGS 1984	101	WPL	63, 148, 150
Wi-Fi	10, 13	Wrecks	40, 46, 69, 87, 89, 91
width	71	X	
Wind speed	94	XTE	85, 103, 148, 150, 162
Windows Multimedia Player	10	XTE Alarm	103
WMA	128	Z	
WPA	162	ZOOM 200kHz	96
WPA-Personal	162	ZOOM 50kHz	96
WPA-PSK	114	ZOOM Keys	14
WPA2	162	zooming	20

PLEASE NOTE

United States: To receive warranty service, the purchaser must deliver the Product, transportation and Insurance prepaid, to STANDARD HORIZON (Marine Division of Vertex Standard) - Attention Factory Service - 6125 Phyllis Drive - Cypress, CA 90630, include proof of purchase indicating model, serial number and date of purchase. This warranty only extends to Products sold within the 50 States of the United States of America and the District of Columbia.

Europe: Contact details for warranty in Europe are available from the dealer in your country or from www.standardhorizon.co.uk where details of warranty terms and contact details for Europe can be obtained.

For Limited Warranty details outside United States and Europe, contact the dealer in your country.

STANDARD HORIZON LIMITED WARRANTY

STANDARD HORIZON (the Marine Division of Vertex Standard) warrants, to the original purchaser only, each new Marine Product ("Product") manufactured and/or supplied by STANDARD HORIZON against defects in materials and workmanship under normal use and service for a period of 3 years from the date of purchase.

In the event of a defect, malfunction or failure of the Product during the warranty period, STANDARD HORIZON's liability for any breach of contract or any breach of express or implied warranties in connection with the sale of Products shall be limited solely to repair or replacement, at its option, of the Product or part(s) therein which, upon examination by STANDARD HORIZON, appear to be defective or not up to factory specifications. STANDARD HORIZON may, at its option, repair or replace parts or subassemblies with new or reconditioned parts and subassemblies.

STANDARD HORIZON will not warrant installation, maintenance or service of the Products. In all instances, STANDARD HORIZON's liability for damages shall not exceed the purchase price of the defective Product.

STANDARD HORIZON will pay all labor and replacement parts charges incurred in providing the warranty repair service except where purchaser abuse or other qualifying exceptions exist. The purchaser must pay any transportation expenses incurred in returning the Product to STANDARD HORIZON for service.

This limited warranty does not extend to any Product which has been subjected to misuse, neglect, accident, incorrect wiring by anyone other than STANDARD HORIZON, improper installation, or subjected to use in violation of instructions furnished by STANDARD HORIZON, nor does this warranty extend to Products on which the serial number has been removed, defaced, or changed. STANDARD HORIZON cannot be responsible in any way for ancillary equipment not furnished by STANDARD HORIZON which is attached to or used in connection with Products, or for the operation of the Product with any ancillary equipment, and all such equipment is expressly excluded from this warranty. STANDARD HORIZON disclaims liability for range, coverage, or operation of the Product and ancillary equipment as a whole under this warranty.

STANDARD HORIZON reserves the right to make changes or improvements in Products, during subsequent production, without incurring the obligation to install such changes or improvements on previously manufactured Products. The implied warranties which the law imposes on the sale of this Product are expressly LIMITED, in duration, to the time period specified above. STANDARD HORIZON shall not be liable under any circumstances for consequential damages resulting from the use and operation of this Product, or from the breach of this LIMITED WARRANTY, any implied warranties, or any contract with STANDARD HORIZON. IN CONNECTION WITH THE SALE OF ITS PRODUCTS, STANDARD HORIZON MAKES NO WARRANTIES, EXPRESS OR IMPLIED AS TO THE MERCHANTABILITY OR FITNESS FOR A PARTICULAR PURPOSE OR OTHERWISE, EXCEPT AS EXPRESSLY SET FORTH HEREIN.

Some Countries in Europe and States of the USA do not allow the exclusion or limitation of incidental or consequential damages, or limitation on how an implied warranty lasts, so the above limitation or exclusions may not apply. This warranty provides specific rights, there may be other rights available which may vary between countries in Europe or from state to state within the USA.



Yaesu UK Ltd
 Unit 12, Sun Valley Business Park
 Winnall Close
 Winchester SO23 0LB
 United Kingdom
 Tel: +44 (0)1962 866667
 Fax: +44 (0)1962 856801
 Email: sales@yaesu.co.uk

Declaration of Conformity

Nr. YUK-DOC-1101-11

We, Yaesu UK Ltd. certify and declare under our sole responsibility that the following equipment complies with the essential requirements of the Directive 1999/5/EC, with the provisions of Annex III (Conformity Assessment procedure referred to in article 10)

Type of Equipment:	Chart Plotter for Marine Navigation with internal GPS receiver
Brand Name:	Standard Horizon
Model Number	CPN700i
Manufacturer	TWS S.r.l
Address of Manufacturer:	Via Zaccagna 6, 54033 Carrara Italy

Applicable Standards:

This equipment is tested to and conforms to the essential requirements of directive, as included in following standards:

Test	Standard
Conducted Emissions	IEC EN 60945:2002
Radiated Emissions	ETSI EN 301 489-1 V1.8.1
Radiated interference	ETSI EN 301 489-17 V2.1.1
Radiated RF immunity	
Receiver requirements	ETSI EN 300 328 V1.7.1
Electrostatic Discharge ESD	IEC EN 60945:2002
Conducted RF interference	ETSI EN 301 489-1 V1.8.1
Conducted RF immunity	ETSI EN 301 489-17 V2.1.1
Compass Safe Distance	IEC EN 60945:2002 ISO/R 694
EFT – Bursts Fast Transients	IEC EN 60945:2002 ETSI EN 301 489-1 V1.8.1 ETSI EN 301 489-17 V2.1.1
DC Power Interruptions, Variation and Polarity inversions	IEC EN 60945:2002 ETSI EN 301 489-1 V1.8.1 ETSI EN 301 489-17 V2.1.1
Safety: Part 1	IEC EN 60950-1:2006/A1:2010
General Requirements	

The technical documentation as required by the Conformity Assessment procedures is kept at the following address:

Company: Yaesu UK Ltd
 Address: Unit 12, Sun Valley Business Park,
 Winnall Close, Winchester SO23 0LB

Technical Construction File: Issued by Vertex Standard Co., Ltd., Tokyo, Japan
 File No: UK7001111

Drawn up in: Winchester, United Kingdom
 Date: 24th November 2011

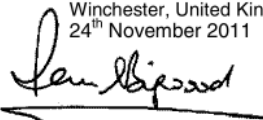
Name and position: PCJ Bigwood,
 Technical Sales Manager



Yaesu UK Ltd
 Unit 12, Sun Valley Business Park
 Winnall Close
 Winchester SO23 0LB
 United Kingdom
 Tel: +44 (0)1962 866667
 Fax: +44 (0)1962 856801
 Email: sales@yaesu.co.uk

Declaration of Conformity

Nr. YUK-DOC-1102-11

We, Yaesu UK Ltd. certify and declare under our sole responsibility that the following equipment complies with the essential requirements of the Directive 1999/5/EC, with the provisions of Annex III (Conformity Assessment procedure referred to in article 10)

Type of Equipment:	Chart Plotter for Marine Navigation with internal GPS receiver
Brand Name:	Standard Horizon
Model Number	CPN1010i
Manufacturer	TWS S.r.l
Address of Manufacturer:	Via Zaccagna 6, 54033 Carrara Italy

Applicable Standards:

This equipment is tested to and conforms to the essential requirements of directive, as included in following standards:

Test	Standard
Conducted Emissions	IEC EN 60945:2002
Radiated Emissions	ETSI EN 301 489-1 V1.8.1
Radiated interference	ETSI EN 301 489-17 V2.1.1
Radiated RF immunity	
Receiver requirements	ETSI EN 300 328 V1.7.1
Electrostatic Discharge ESD	IEC EN 60945:2002
Conducted RF interference	ETSI EN 301 489-1 V1.8.1
Conducted RF immunity	ETSI EN 301 489-17 V2.1.1
Compass Safe Distance	IEC EN 60945:2002 ISO/R 694
EFT – Bursts Fast Transients	IEC EN 60945:2002 ETSI EN 301 489-1 V1.8.1 ETSI EN 301 489-17 V2.1.1
DC Power Interruptions, Variation and Polarity inversions	IEC EN 60945:2002 ETSI EN 301 489-1 V1.8.1 ETSI EN 301 489-17 V2.1.1
Safety: Part 1 General Requirements	EN 60950-1:2006/A1:2010

The technical documentation as required by the Conformity Assessment procedures is kept at the following address:

Company: Yaesu UK Ltd
 Address: Unit 12, Sun Valley Business Park,
 Winnall Close, Winchester SO23 0LB

Technical Construction File: Issued by Vertex Standard Co., Ltd., Tokyo, Japan
 File No: UK10101111

Drawn up in:
 Date:

Winchester, United Kingdom
 24th November 2011



Name and position:

PCJ Bigwood,
 Technical Sales Manager