

STANDARD HORIZON

Nothing takes to water like Standard Horizon

CPN700i/CPN1010i

Multimedia Chart Plotters

Owner's Manual



CPN700i

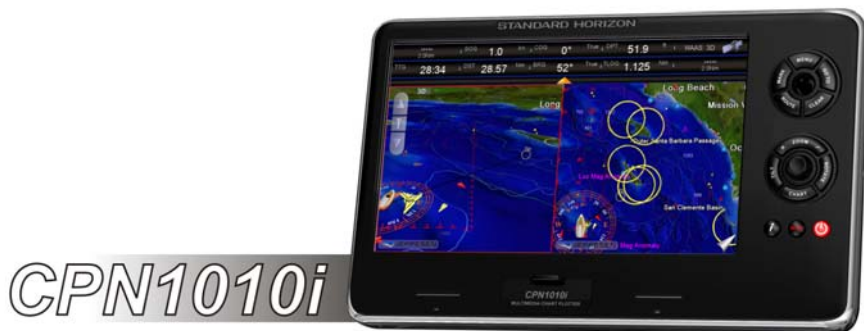

CPN1010i



WARNING!

Electronic charts displayed by the CPN Series Chart Plotter are believed to be accurate and reliable, but are not intended to be a substitute for the official charts, which should remain your main reference for all matters related to the execution of safe navigation. For this reason you should always keep the official published and approved nautical charts on board.



CONTAINS FCC-ID: CU9-6658001
CONTAINS IC: 10307A-6658001

This device complies with Part 15 of the FCC limits for Class A digital devices. This equipment generates, uses and can radiate radio frequency energy and, if not installed or used in accordance with the instructions may cause harmful interference with radio communications.

There is no guarantee that interference will not occur in a particular instance. If this equipment does cause harmful interference to other equipment, try to correct the problem by relocating the equipment.

Consult an authorized STANDARD HORIZON dealer or other qualified service technician if the problem cannot be corrected. Operation is subject to the following conditions: (1) This device cannot cause harmful interference, and (2) this device must accept any interference received, including interference that may cause undesired operation.



CAUTION

- The CPN Series Chart Plotter is designed for maritime use. To avoid water intrusion, ensure the C-MAP BY JEPPESEN SD CARD door is completely closed.*
- Extensive exposure to heat may result in damage to the CPN Series Chart Plotter.*
- The CPN Series Chart Plotter contains dangerous high-voltage circuits which only experienced technicians can handle.*
- STANDARD HORIZON will not be liable for errors contained herein, or for incidental or consequential damages in connection with the performance or use of this material.*
- Because we frequently update our software and applications, the pictures shown throughout this Owner's Manual may be slightly different from what you see on your CPN Series Chart Plotter.*

The *Bluetooth*[®] word mark and logos are owned by the Bluetooth SIG Inc., Wi-Fi[®] is a registered trademark of the Wi-Fi Alliance[®] and any use of such name by STANDARD HORIZON Marine Division of YAESU USA is under license. Windows[®] and Windows CE[®] are registered trademarks of Microsoft Corporation in the United States and/ or other countries. MicroSD[™] is a trademark of SanDisk or its subsidiaries. Zetakey[™] Browser is a trademark of Zetakey Solutions Limited.

Copyright 2013. YAESU MUSEN CO., LTD. All rights reserved. Printed in Italy.

No portion of this manual may be reproduced without the permission of YAESU MUSEN CO., LTD.

This Owner's Manual is updated to the software version v. 2.0.8.603

OM CODE: SH-CPN-07-X51-CE 2.0.8.603e86A & SH-CPN-10-X51-CE 2.0.8.603e87A - 240413

TABLE OF CONTENTS

| | |
|---|-----------|
| INTRODUCTION | 11 |
| PACKING LIST | 12 |
| OPTIONAL ACCESSORIES | 13 |
| MANUAL CONVENTIONS | 13 |
| 1 - GENERAL OPERATION | 14 |
| 1.1 POWER UP SEQUENCE | 14 |
| 1.1.1 POWERING OFF | 14 |
| 1.1.2 BRIGHTNESS CONTROL | 15 |
| 1.2 CHART PLOTTER FRONT PANEL | 15 |
| 1.2.1 TOUCHSCREEN | 16 |
| Touchscreen Disabling (Chart Plotter Mode only) | 17 |
| Touchscreen Keys | 17 |
| Touchscreen Keyboard | 18 |
| Touchscreen Keyboard for Chart Plotter Mode | 18 |
| Touchscreen Keyboard for other applications | 18 |
| 1.2.2 MENU DESCRIPTION | 18 |
| Warning window | 19 |
| Information window | 19 |
| 1.2.3 SELECTING AN ITEM | 20 |
| 1.3 CHART PLOTTER CONTROLS | 20 |
| 1.3.1 KEYS | 20 |
| 1.3.2 PLAYING MUSIC IN BACKGROUND (Chart Plotter Mode only) | 23 |
| Starting music in background | 23 |
| Stopping music in background | 23 |
| 1.3.3 SOFT KEYS (Chart Plotter Mode only) | 23 |
| Closing Soft Keys | 24 |
| 1.4 MEMORY DEVICES SAFELY REMOVAL | 24 |
| 2 - CHART PLOTTER | 25 |
| 2.1 GETTING STARTED | 25 |
| 2.1.1 SWITCHING BETWEEN MODES | 26 |
| Default Mode | 26 |
| Home vs Cursor Mode | 26 |
| Cursor Mode | 26 |
| Switching between 2D and 3D modes | 27 |
| 2.1.2 MENU SYSTEM | 28 |
| 2.1.3 INITIAL SETUP | 29 |
| Cursor and Menu Selection Speed | 29 |
| Changing the Ship Icon | 29 |
| Selecting Course Up/North Up | 30 |
| Pages Selection | 30 |
| Assigning Page Soft Keys | 32 |
| Time Setup | 32 |
| Selecting Coordinate System | 34 |
| Loran TD | 34 |
| Changing the Display Color | 34 |
| Selecting Language | 35 |
| Chart Control Icon | 36 |
| 2.1.4 SETTINGS IN GENERAL SETUP MENU | 37 |

| | | |
|--------|---|----|
| 2.2 | CARTOGRAPHY OVERVIEW | 39 |
| 2.2.1 | BUILT-IN CHARTS - For North America users only | 39 |
| | Updating Built-In Charts | 39 |
| | C-MAP 4D | 41 |
| | C-MAP 4D: MAX Content | 42 |
| | C-MAP 4D: FULL 4D Content | 42 |
| | C-MAP 4D: Value Added Data | 43 |
| 2.2.2 | VALUE ADDED DATA MENU | 43 |
| 2.3 | REMOVING THE SD CARD | 43 |
| 2.4 | USING FIND SERVICES | 44 |
| 2.4.1 | PORT SERVICES | 44 |
| 2.4.2 | PORT | 46 |
| 2.4.3 | TIDE STATIONS | 46 |
| | Changing the day | 47 |
| | Changing Tide Station | 47 |
| 2.4.4 | WRECKS | 47 |
| 2.4.5 | OBSTRUCTIONS | 48 |
| 2.4.6 | LAKES INFORMATIONS | 48 |
| 2.4.7 | QUICK AND FULL INFO ON LAKES | 49 |
| 2.4.8 | LAKES BY NAME | 50 |
| 2.4.9 | POINTS OF INTEREST | 50 |
| 2.4.10 | USER POINTS | 51 |
| 2.4.11 | COORDINATES | 51 |
| 2.4.12 | INFORMATION | 52 |
| 2.5 | CHART DISPLAY FUNCTIONS | 52 |
| 2.5.1 | 4D FUNCTIONS | 52 |
| | Chart Window | 52 |
| | Display Mode | 53 |
| | Overlay | 53 |
| | Overlay Mode | 54 |
| | Transparency | 54 |
| | 3D Exaggeration Factor | 54 |
| 2.5.2 | GENERAL CHART DISPLAY FUNCTIONS | 55 |
| | Icons Size | 55 |
| | Place Names Size | 55 |
| | Safety Status Bar (DSI - Data Safety Indicator) | 56 |
| | Currents Prediction | 56 |
| | Chart Language | 57 |
| | Course Up/North Up | 58 |
| | Nav-Aids Presentation | 58 |
| | Ship Icon | 58 |
| | Course Time Line | 59 |
| | Compass Indicator | 59 |
| | Ship Icon Position | 59 |
| 2.5.3 | PICTURES & DIAGRAMS | 60 |
| | How to show Pictures or Diagrams of an Object | 60 |
| 2.6 | CREATING MARKS | 61 |
| 2.6.1 | CREATING A NEW MARK ON THE CHART PAGE | 61 |
| 2.6.2 | EDITING A MARK OR WAYPOINT | 61 |
| 2.6.3 | DELETING A MARK OR WAYPOINT | 62 |
| 2.6.4 | MOVING A MARK OR WAYPOINT | 62 |
| 2.6.5 | MARKS/WAYPOINTS (USER POINTS) LIST | 63 |
| 2.6.6 | CREATING/MODIFYING A MARK IN THE USER POINTS LIST | 64 |

| | | |
|--------|--|----|
| 2.7 | ROUTES | 65 |
| 2.7.1 | CREATING A ROUTE USING WAYPOINTS | 66 |
| 2.7.2 | CHANGING THE NAME OF A ROUTE | 66 |
| 2.7.3 | CREATING AN OLYMPIC ROUTE OR BOUNDARY | 67 |
| 2.7.4 | MAKING ADDITIONAL ROUTES | 68 |
| 2.7.5 | CREATING A ROUTE USING MARKS ON THE CHART PAGE | 68 |
| 2.7.6 | INSERTING A WAYPOINT INTO A ROUTE | 69 |
| 2.7.7 | DELETING A ROUTE | 69 |
| 2.7.8 | OTHER SETTINGS IN ROUTE MENU | 69 |
| 2.7.9 | ROUTE CHECK | 70 |
| 2.7.10 | EASY ROUTING (ER) | 71 |
| | Warning Messages | 74 |
| 2.8 | GOTO KEY OPERATION | 75 |
| 2.8.1 | GOTO CURSOR | 75 |
| 2.8.2 | GOTO A ROUTE | 76 |
| | Using GOTO to select a Route | 76 |
| | Using the ShuttlePoint knob | 77 |
| 2.8.3 | GOTO MARK | 77 |
| 2.9 | MAN OVER BOARD (MOB) FUNCTION | 77 |
| 2.9.1 | PLACING A MOB POINT | 78 |
| 2.9.2 | DELETING A MOB POINT | 78 |
| 2.10 | TRACKS | 78 |
| 2.10.1 | SAVING AND STARTING A NEW TRACK | 79 |
| 2.10.2 | DELETING A TRACK | 80 |
| 2.10.3 | OTHER SETTINGS IN THE TRACK MENU | 80 |
| 2.11 | TRIP LOG | 80 |
| 2.11.1 | TRIP LOG SELECTION IN DATA WINDOW | 80 |
| 2.11.2 | RESETTING THE TRIP LOG | 81 |
| 2.12 | USER SD CARD | 81 |
| 2.12.1 | INITIALIZING THE SD CARD | 82 |
| 2.12.2 | TRANSFERRING FILES TO A USER SD CARD | 82 |
| 2.12.3 | LOADING A FILE FROM A USER SD CARD | 83 |
| 2.12.4 | DELETING A FILE FROM A USER SD CARD | 83 |
| 2.12.5 | REFRESHING A USER SD CARD | 83 |
| 2.13 | MAIN MENU | 84 |
| 2.13.1 | SELECTING A PAGE OR MENU | 84 |
| 2.13.2 | CUSTOMIZING A PAGE ICON | 85 |
| 2.13.3 | CHART PAGE | 85 |
| | Single | 86 |
| | Dual | 86 |
| | Data Window Selections | 86 |
| | Customizing Data Windows | 87 |
| | Collapsing Data Windows | 88 |
| | Additional Functions on Chart page: Information on Objects | 89 |
| | Display Mode | 90 |
| | Marine Settings | 91 |
| | Depth Settings | 92 |
| | Chart Settings | 92 |
| | Underwater Objects Settings | 93 |
| 2.13.4 | NAVIGATION PAGES | 94 |
| | Highway page | 94 |
| | Chart/Highway page | 94 |
| | Compass page | 95 |

| | | |
|---------|---|-----|
| | GPS Status page | 95 |
| | GPS Setup Menu | 96 |
| | WAAS/EGNOS Setting | 96 |
| 2.13.5 | NMEA PAGES | 96 |
| | NMEA Digital page | 96 |
| | Customizing data boxes in the NMEA Digital page | 97 |
| | Analog page | 98 |
| | Engine & Chart (Combo) page | 99 |
| | Monitor page | 99 |
| 2.13.6 | FISH FINDER (optional FF525 required) | 100 |
| 2.13.7 | TIDE PAGE | 100 |
| | Tides | 100 |
| 2.13.8 | VHF DIGITAL SELECTIVE CALLING | 101 |
| | NMEA-0183/NMEA-2000 Interfacing | 101 |
| | Distress Call | 102 |
| | Position Request | 102 |
| | DSC Directory | 102 |
| 2.13.9 | VIDEO INPUT | 103 |
| | Video Input menu | 103 |
| | Video adjustment mode | 104 |
| | Restore Defaults | 104 |
| 2.13.10 | ALARMS | 104 |
| | Alarms Setup menu | 105 |
| | Engine Alarm Report | 105 |
| | Grounding Alarm Report | 106 |
| | System Alarm Report | 106 |
| 2.14 | ADVANCED SETTINGS | 106 |
| 2.14.1 | NAVIGATE MENU | 107 |
| | Loran TD | 107 |
| 2.14.2 | COMPASS (COG) SETUP | 107 |
| 2.14.3 | DATA SOURCE PRIORITY SELECTION | 108 |
| 2.14.4 | ENGINES NAME SELECTION | 109 |
| 2.14.5 | INPUT/OUTPUT (NMEA-0183) CONNECTIONS | 109 |
| | Input/Output | 109 |
| | NMEA-0183 Output sentences | 110 |
| 2.14.6 | SIMULATION | 110 |
| | Navigating a Route in Simulation Mode | 110 |
| 2.14.7 | DSC POLLING | 111 |
| 2.14.8 | ABOUT PAGE | 111 |
| | DAM Report page | 112 |
| 2.15 | AIS | 113 |
| 2.15.1 | SYSTEM DEFINITIONS | 113 |
| 2.15.2 | AIS SETUP MENU | 114 |
| 2.15.3 | QUICK INFO ON AIS TARGET | 114 |
| 2.15.4 | AIS TARGET COLORS | 115 |
| 2.15.5 | AIS-SART | 115 |
| | AIS-SART Test mode | 116 |
| 2.15.6 | AIS LIST | 116 |
| 2.16 | C-MAP WEATHER FORECASTS SERVICE | 117 |
| 2.16.1 | C-MAP Weather page | 117 |
| | Download via Wi-Fi® connection | 118 |
| | Download from SD CARD | 118 |
| | Forecast | 119 |

| | |
|--|------------|
| 3 - CONNECTION MANAGER | 120 |
| 3.1 GETTING STARTED | 120 |
| 3.2 STARTING THE CONNECTION MANAGER | 120 |
| 3.3 CONNECTION MANAGER OVERVIEW | 121 |
| 3.3.1 Wi-Fi® CONNECTION | 121 |
| 3.3.2 Wi-Fi® STANDARDS SUPPORTED | 121 |
| 3.3.3 CONNECTION MANAGER CONTROLS | 122 |
| 3.4 HOW TO CONNECT | 122 |
| 3.4.1 AUTHENTICATION/ENCRYPTION PROTOCOLS | 123 |
| 3.5 NETWORKING CONNECTION: C-MAP 4D CHARTS, NMEA & FISH FINDER DATA SHARING | 124 |
| 3.5.1 CPN SERIES CHART PLOTTER SETUP | 124 |
| Chart Plotter 1 Setup (with C-MAP 4D CARD inserted) | 125 |
| Chart Plotter 2 Setup (no chart inserted) | 126 |
| Custom Setup | 128 |
| 3.6 PAIRING THE CPN MULTIMEDIA CHART PLOTTERS WITH Bluetooth® WIRELESS TECHNOLOGY | 128 |
| 3.6.1 ACTIVATION OF Bluetooth® DEVICE | 129 |
| 3.6.2 PAIRING Bluetooth® DEVICE | 129 |
| 3.6.3 UNPAIRING Bluetooth® DEVICE | 131 |
| 4 - INTERNET BROWSER | 132 |
| 4.1 GETTING STARTED | 132 |
| 4.2 STARTING THE INTERNET BROWSER | 132 |
| 4.3 BROWSER OVERVIEW | 133 |
| 4.3.1 INTERNET BROWSER CONTROLS | 134 |
| 4.4 HOW TO NAVIGATE | 135 |
| 4.5 THE FAVORITES PAGE | 136 |
| 4.6 THE HISTORY LIST | 136 |
| 4.7 PLAYING MEDIA CONTENTS | 137 |
| 4.8 DOWNLOADING PDF FILES | 137 |
| 5 - MEDIA PLAYER | 138 |
| 5.1 GETTING STARTED | 138 |
| 5.2 STARTING MEDIA PLAYER | 138 |
| 5.3 OVERVIEW | 139 |
| 5.4 MEDIA PLAYER CONTROLS | 140 |
| 5.5 DISPLAYING PDF FILES | 142 |
| 5.6 SAVING FILES ON A USB THUMB DRIVE | 143 |
| 6 - INSTALLATION | 144 |
| 6.1 MOUNTING THE CPN SERIES CHART PLOTTER | 144 |
| 6.1.1 BRACKET MOUNTING | 144 |
| 6.1.2 FLUSH MOUNTING THE CPN SERIES CHART PLOTTER | 145 |
| 6.2 MOUNTING THE OPTIONAL EXTERNAL GPS ANTENNA | 147 |
| 6.2.1 FLUSH MOUNTING THE ANTENNA | 147 |
| 7 - CONNECTIONS | 148 |
| 7.1 OVERVIEW | 148 |
| 7.1.1 BATTERY CONNECTIONS | 149 |
| Warning: product installation and operation | 150 |
| Warning: product grounding | 150 |
| 7.1.2 NMEA-0183 CONNECTIONS | 152 |
| PWR/ACC1 Connections | 154 |
| ACC2 Connections | 154 |
| PORT Input selections | 154 |
| PORT Output sentences | 154 |

| | |
|---|------------|
| CPN Series Chart Plotter to NMEA-0183 connection examples | 154 |
| 7.1.3 VIDEO INPUT CONNECTOR | 157 |
| 7.1.4 VIDEO INPUT CONNECTIONS for CPN700i | 157 |
| 7.1.5 VIDEO INPUT/OUTPUT CONNECTIONS for CPN1010i | 157 |
| 7.1.6 PRE-AMP OUTPUT-EXTERNAL AMPLIFIER/SPEAKER CONNECTIONS | 158 |
| CPN Pre-Amp connector pin out | 158 |
| 7.1.7 OPTIONAL USB THUMB DRIVE | 159 |
| 7.1.8 OPTIONAL GPS ANTENNA | 159 |
| 7.1.9 OPTIONAL FF525 BLACK BOX FISH FINDER | 159 |
| 7.1.10 OPTIONAL EXTERNAL ALARM CONNECTION | 159 |
| 7.1.11 SECOND CPN TO SHARE C-MAP 4D CHARTS, NMEA & FF DATA .. | 160 |
| 7.1.12 NMEA-2000 DEVICES | 161 |
| 8 - SPECIFICATIONS | 162 |
| 8.1 CPN700i | 162 |
| 8.1.1 DIMENSIONS | 163 |
| 8.2 CPN1010i | 163 |
| 8.2.1 DIMENSIONS | 164 |
| 8.3 OPTIONAL FF525 FISH FINDER | 165 |
| 8.4 OPTIONAL WAAS GPS RECEIVER | 166 |
| 8.4.1 GPS CONNECTION IMAGE | 167 |
| 9 - TECHNICAL TESTS | 168 |
| 9.1 SYSTEM TEST | 168 |
| 9.1.1 RAM MENU (RESET) | 168 |
| RAM Clear | 168 |
| 9.1.2 BACKLIGHT | 169 |
| 9.1.3 CARTRIDGES (used by Standard Horizon Technicians) | 169 |
| Internal Data Base Test | 169 |
| SD CARD Test | 169 |
| 9.1.4 SERIAL PORTS (used by Standard Horizon Technicians) | 169 |
| Change Parameters | 169 |
| Input Data Display | 169 |
| Loop-Back Test | 169 |
| 10 - SYSTEM UPDATE | 170 |
| 10.1 SYSTEM UPDATE PROCEDURE | 170 |
| 10.2 SYSTEM UPDATE ERROR MESSAGES | 171 |
| 10.2.1 ERROR MESSAGES 01, 02, 03, 04, 05, 06, 07, 09 | 171 |
| 10.2.2 ERROR MESSAGE 08 | 172 |
| 10.2.3 ERROR MESSAGES 20, 21, 22 | 172 |
| TERMS | 174 |
| ANALYTICAL INDEX | 177 |

INTRODUCTION

Congratulations on your purchase of the STANDARD HORIZON CPN Series Chart Plotter. Whether this is your first STANDARD HORIZON product or not, we are committed to ensuring your enjoyment and satisfaction with this unit. Our Technical support personnel stand behind every product we sell. Post-Sales Support can be obtained from your local dealer or distributor. North American customers should contact STANDARD HORIZON at 714-827-7600 or by email marinetech@yaesu.com. UK customers should contact STANDARD HORIZON at 01962 866667 or email marinesales@standardhorizon.co.uk. European customers should contact their local dealer or distributor for support.



Information in this Owner's Manual is subject to change without notice.

The CPN700i and CPN1010i are precision-crafted high-performance receivers for the Global Positioning System (WAAS GPS) constellation of satellites. The internal or optional GPS antenna provides precise location data with a host of navigation features ideal for nautical use. The CPN700i and CPN1010i are housed in rugged, impact-resistant cases with outstanding ergonomic design for effortless operation. The CPN700i and CPN1010i are IP57 waterproof.

The advanced features of the CPN Series Chart Plotter include:

- Built-In Charts¹ for coastal navigation of USA including Alaska, Hawaii and Great Lakes, Canada, Bahamas, Caribbean, Cuba, Mexico, Puerto Rico, and Central America. Fresh water coverage is not included. Detailed coverage and Fresh waters charts are available from Jeppesen.
- Optional C-MAP 4D Cartography:
 - 3D View
 - Satellite Images
 - Raster Charts
 - Easy Routing
 - Value Added Data
- Display:
 - Sunlight viewable
 - Bonded with bright LED (1000 nits) backlight
 - CPN700i: 7" Wide VGA 800x480
 - CPN1010i: 10" Wide SVGA 1024x600
- Optional 50 channel WAAS GPS antenna with 30ft of cable
- Network interfaces:
 - Built-In Wi-Fi[®] and *Bluetooth*[®] capability
 - USB 2.0 Connection compatible keyboard² or memory stick
 - NMEA-0183
 - NMEA-2000
- Built-In Zetakey™ Browser, Media Player and PDF reader
- Front panel stereo and pre-amp outputs for optional audio amp

- Video Input:
 - CPN700i: 1 NTSC or PAL
 - CPN1010i: 2 NTSC or PAL
- AIS and FF525 Fish Finder compatible
- C-MAP Weather Service predictions
- Dual Chart windows with independent zoom levels
- Selectable Sail boat and Power boat Ship Icons
- Compass Rose indication around Ship Icon
- Route Check and Easy Routing
- Guardian Alarm
- Engine Alarms
- Enhanced Color AIS Targets
- Dedicated AIS List page
- AIS-SART, AIS-MOB and AIS-EPIRB handling
- Navigate to an Olympic Route
- Displays DSC Distress and Position Report calls received from a DSC VHF radio
- 3-years waterproof warranty

 For North America users only.













PACKING LIST

When the package containing the Chart Plotter is first opened, please check for the following contents.

Accessories and replacements parts may be ordered in North America by contacting STANDARD HORIZON's Parts department at 714-827-7600 Extn. 6800 or by email at marineparts@yaesu.com. UK customers may contact STANDARD HORIZON at 01962 866667 or by email to service@yaesu.co.uk.

| PART CODE | ITEM |
|-----------|---------------------------------|
| S8003046 | External bracket (CPN700i) |
| S8003043 | External bracket (CPN1010i) |
| S8003048 | Bracket knob |
| S8003045 | Dust cover (CPN700i) |
| S8003042 | Dust cover (CPN1010i) |
| T9101553 | PWR ACC1 & ACC2 cable |
| S8003044 | Flush Mount Bracket |
| EM052U560 | Flush Mount Template (CPN700i) |
| EM053U560 | Flush Mount Template (CPN1010i) |
| XUCMP0052 | 2 Amp fuse and holder |
| EM052U101 | Owner's Manual |
| EM052U501 | Quick Reference Guide |

OPTIONAL ACCESSORIES

| ACCESSORIES | PARTS NAME | ITEM |
|---|--|--|
|  | Q7000619A 50 Channel GPS Antenna with 30 feet rooting cable |  DST521 600W Transom mount depth, speed temp Transducer |
|  | ACVC10 Video Adapter cable |  DST523 600W 2" Bronze Thru-hull depth temp Transducer |
|  | VGAC10 VGA Adapter cable <i>(only for CPN1010i)</i> |  DST525 600W In-hull Transducer |
|  | ACAC10 Audio Output Adapter cable |  DST526 600W 2" Bronze Thru-hull depth, speed temp Transducer |
|  | FF525 50/200kHz Black Box Fish Finder |  DST527 1000W In-hull depth Transducer |
|  | DST520 600W 2" Nylon Thru-hull depth temp Transducer |  DST528A 1000W Bronze long stem depth temp Transducer |

MANUAL CONVENTIONS

This Owner's Manual includes information for both the 7inch CPN700i and 10inch CPN1010i Multimedia Chart Plotters which are referenced to CPN Series Chart Plotters throughout this manual. In addition when a word(s) is bold and underlined it is referring to a menu selection on the display.

 The screen images on this Owner's Manual refer to the CPN700i Series Chart Plotter unless specified.

1 - GENERAL OPERATION

1.1 POWER UP SEQUENCE

1. Press the  PWR key until the display shows the Splash Screen page (see A).



2. The Startup Screen page will be displayed in approximately 30-45 seconds (see B). This page allows selection of the Chart Plotter, Media Player (video, audio and images), Internet Browser and Connection Manager (for Wi-Fi®, Bluetooth® and Ethernet setup). If a selection is not made within 30 seconds, the CPN Series Chart Plotter automatically changes to Chart Plotter Mode.

1.1.1 POWERING OFF

1. The CPN Series Chart Plotters have three modes of operation. The GPS Chart Plotter, Internet and Multimedia modes. When the CPN Series Chart Plotter is in any of these modes and the  PWR key is pressed and held, a Shut Down window¹ will be shown:

 ¹ **FOR CHART PLOTTER MODE ONLY:** The **TOUCH SCREEN LOCK / TOUCH SCREEN UNLOCK** option is present only in Chart Plotter Mode. It allows to disable touchscreen functionality for the Chart Plotter application. See also "Touchscreen Disabling" in the Par. 1.2.1 "Touchscreen".

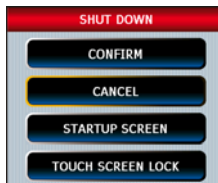







2. To turn off the CPN Series Chart Plotter, tap on **CONFIRM**. To show the Startup Screen page tap on **STARTUP SCREEN**. To exit from the Shut Down menu, tap on **CANCEL**.

1.1.2 BRIGHTNESS CONTROL

With the CPN Series Chart Plotter turned On, briefly press the  PWR key to show the Brightness control window.







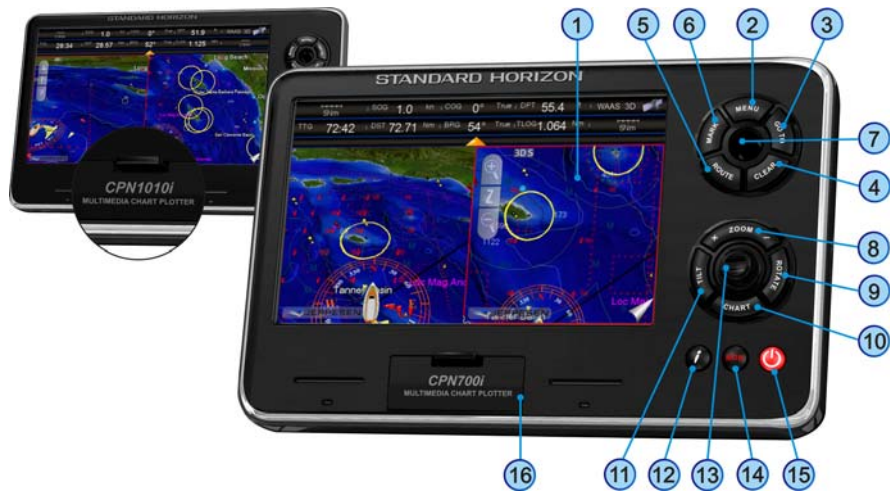

On the Brightness window, tap on  to increase or  to decrease the display backlight (or move the  ShuttlePoint knob to the right or left); when finished, tap on  to save the selection and exit the brightness setting mode.

 The Brightness control is available also using the  Intelligent key.



1.2 CHART PLOTTER FRONT PANEL







- | | |
|---|---|
|  Touchscreen | touch the screen to interact with the Chart page, Menus, Internet or Multimedia modes |
|  MENU key | selects the Main Menu |
|  GOTO key | shows the GOTO popup window and allows selection of Go To Cursor, Saved Mark or Route |
|  CLEAR key | cancels current operation |
|  ROUTE key | creates Waypoints to make a Route when on the Chart page |

- 6 MARK key places a Mark when on the Chart page
 - 7 ShuttlePoint knob moves the cursor on the Chart page and selects items in menus
 - 8 ZOOM keys changes the scale of the chart to show a smaller or a wider area. When pressed allows the rotary knob or touch screen controls to be used to change zoom levels.
 - 9 ROTATE key enables the chart to be rotated using the rotary knob or touch screen controls
 - 10 CHART key selects the Chart Menu to change between 2D and 3D chart modes and selects Vector, Satellite, or Raster chart display
 - 11 TILT key enables the chart to be tilted using the rotary knob or touch screen controls
 - 12 MOB key places a Man Over Board mark
 - 13 Rotary knob used to enter a function or rotate, tilt and zoom the chart
 - 14 Intelligent key opens a window to select Internet Browser, Multimedia Player, adjust Brightness and Touchscreen Calibration
-
- ! Internet and Multimedia videos can not be accessed while in Chart Mode mode, however you can listen to music while navigating (press the  Intelligent key to toggle between Chart Mode and Media Player).
- 15 PWR key turns On/Off the CPN Series Chart Plotter and adjusts brightness
 - 16 SD CARD slot used to insert optional C-MAP 4D Cartography, view pictures, listen to audio files, save User Points and update software from an optional SD CARD.

1.2.1 TOUCHSCREEN

The CPN700i and CPN1010i use a touchscreen display. Many functions are controlled by touching the display or using the dedicated keys,  ShuttlePoint or  rotary knobs.

The Touchscreen Calibration can be selected from the Startup Screen page by pressing and holding the  key for 5 seconds, or by pressing the  Intelligent key from any screen other than Startup Screen. Once the calibration screen is displayed, you must tap on the center of the Cross-Hair as it moves around the screen, following the procedure shown. When completed and prompted press the  rotary knob (or the  ShuttlePoint knob if enabled, see ShuttlePoint Enter item in the Par. 2.1.4 “Settings in General Setup Menu”) to complete the calibration process and store the settings. Calibration mode may be exited without storing the settings by pressing the  key.

! Cleaning of the CPN Series Chart Plotter screen is a very important operation and must be done carefully. Since the surface is covered by an anti-reflective coating, the procedure for cleaning all the surfaces can be performed using the following procedure: use a clean, soft, lint-free cloth to clean the glass. We recommend using a micro-fiber cloth. Spray a small amount of ammonia-free cleaner (isopropyl alcohol) onto the cloth. Spraying on the cloth will prevent overspray. Fold the cloth or lens cloth into a triangular shape, moisten the tip and use the index finger behind a corner to move the cloth across the surface in overlapping side to side strokes. If the cloth is too wet, a noticeable wet film will be left in its path and you

will need to repeat the process. If too dry, the cloth won't glide easily, and may damage the surface.

W When exposed to prolonged periods of direct sunlight, the Touchscreen display can get very hot. In such conditions, avoid using Touchscreen display and use the CPN Series Chart Plotter physical keys instead.

The following is a list of common functions accessed by touching the display:

- Menu items
 - Page selection
 - Keyboard input
 - Page Sweeping
 - Scroll bar movements
 - Panning the chart
 - Pointing and manipulating objects on the chart (cartographic and user objects)
 - Moving the cursor
 - Chart rotation, Panning, Tilting and Zooming
-

! When touching an active object on the screen, the system provides a visual feedback to show the object has been touched (for example the object changes its color when touched).

The following gestures are recognized and interpreted:

- **Flick** (Page sweeping): press and hold a finger on the screen, then drag the finger left or right, then lift up the finger to initiate scrolling.
- **Pan/Move** (Scrolling maps, moving cursor): press a finger on the screen, move the finger in any direction.
- **Tap** (Placing a cursor, activating Soft Keys, selecting objects/Data Boxes/options in menu): shortly press and release a finger on the screen.
- **Hold** (Opening additional related options context depended): press and hold a finger on the screen.

Touchscreen Disabling (CHART PLOTTER MODE ONLY)

Touchscreen disabling functionality can be accessed from the Shut Down window. Tap on **TOUCH SCREEN LOCK** to disable touchscreen for the Chart Plotter application. When touchscreen is disabled (press and hold the **PWR** key until Shut Down window is displayed), some of the Chart Plotter's functionalities are not available, for example usage of Soft Keys or page sweeping. The Touchscreen disabling functionality does not affect Starting Shell, Connection Manager, Internet Browser and Media Player. The Shut Down window is always "touchable" to allow re-enabling of the touchscreen (tapping on **TOUCH SCREEN UNLOCK**).

Touchscreen Keys

The keys that appear on the screen can be in four states:

- **NORMAL** : (BLUE BACKGROUND) key is not selected and not touched.
- **SELECTED** : (BLUE BACKGROUND WITH YELLOW FRAME) key is selected. The selection can be moved using the **ShuttlePoint** knob; if the **ShuttlePoint** knob or the **rotary knob** is pressed, the key related function is executed.
- **TOUCHED** : (RED BACKGROUND) key is touched with a finger. When a key is touched and released its related function is started.
- **DISABLED** : (GREY BACKGROUND) the function assigned to this key is not available at the moment.

Touchscreen Keyboard

A keyboard is used to enter/edit text of User Points or to type a URL when using the Internet Browser. The keyboard is also used for Internet Browser, Media Player and Connection Manager. The keyboard can be operated by the touchscreen or by moving the ● ShuttlePoint knob. A character is entered (turns red) when the key is tapped once or when ● ShuttlePoint knob is pressed.

Touchscreen Keyboard for Chart Plotter Mode

- 1 Edit line
- 2 Closes the keyboard without applying changes
- 3 Applies changes to the input sentence and closes the keyboard
- 4 Moves the selector in the edit field to the previous character in the sentence
- 5 Moves the selector in the edit field to the next character in the sentence

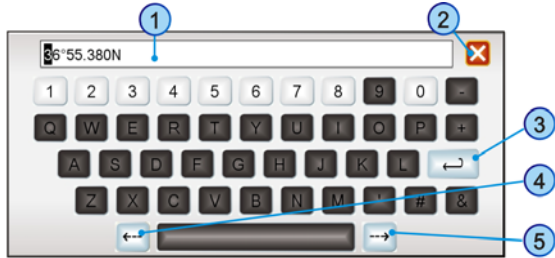

Touchscreen Keyboard for other applications

- 1 Places the Keyboard on bottom or top side of the screen
- 2 Select the character set: (ABC abc 123 àéì)
- 3 Applies changes to the input sentence and closes the Keyboard

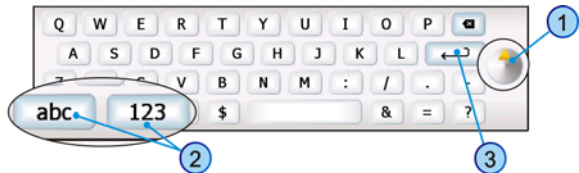

1.2.2 MENU DESCRIPTION

The menu window has the following elements.

- 1 8 Previous menu arrow
- 2 Menu name
- 3 Close window
- 4 Submenu selection (notice the arrow ▶)
- 5 Single menu item
- 6 Menu item list
- 7 Scroll bar

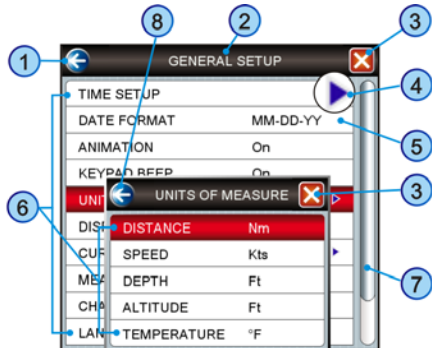

Refer to the previous picture:

- **1** and **8** : a single touch on the arrow icon closes the current menu and displays the previous menu level. In the first menu level it closes the menu and goes back to the Main Menu page (in the example below **1** closes the General Setup menu and goes back to the Main Menu page. **8** closes the Units of Measure menu and displays the General Setup menu).
- **3** : when touched closes all menus.

! Touching **1** or **3** in the first menu level has no effect if there is an opened submenu.

- **6** : list of all menu items present on the current menu level. There are two types of menu items: **4** opens the next menu level. **5** allows choosing one of available options.
- **7** : when touched up/down the bar, scrolls the content of the related window/page. See the following picture.



Warning window

The Warning window will be shown to alert you of critical situations. For example:

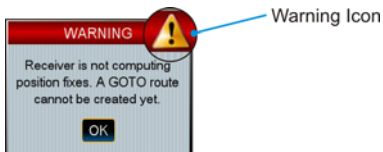

Tap on **OK** to close the Warning window.

Information window

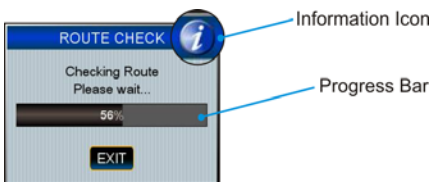

Above you can see an example of an Information window that shows the CPN Series Chart Plotter is computing something. You can choose to wait until done or tap on **EXIT** on the display to exit.

1.2.3 SELECTING AN ITEM

To select and activate a desired item:

- Tap your finger on the display over the item
- or
- Move the ● ShuttlePoint knob up/down to place cursor on the item and then press the ● ShuttlePoint knob to enter (if enabled, see ShuttlePoint Enter item in the Par. 2.1.4 “Settings in General Setup Menu”)
- or
- Move the ● rotary knob left/right to place cursor on the item and then press the ● rotary knob to enter

Refer to the following example:

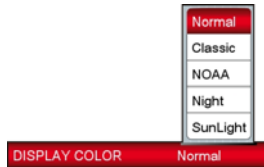

- A. Tap on **DISPLAY COLOR**. A popup window will be shown with the available options. To set Normal palette tap on **Normal**.
- or
- B. Move the ● ShuttlePoint knob up/down to highlight **DISPLAY COLOR** and press the ● ShuttlePoint knob to enter. A popup window will be shown with the available options. To set Normal palette move the ● ShuttlePoint knob up/down to highlight **Normal** and press the ● ShuttlePoint knob to enter.
- or
- C. Move the ● rotary knob left/right to highlight **DISPLAY COLOR** and press the ● rotary knob to enter. A popup window will be shown with the available options. To set Normal palette move the ● rotary knob left/right to highlight **Normal** and press the ● rotary knob to enter.

1.3 CHART PLOTTER CONTROLS

1.3.1 KEYS

The CPN700i and CPN1010i in addition to being able to control functions with the touch display, also have dedicated keys and knobs provided for your convenience. You will notice when a key is pressed a single beep will be produced which means the key press is valid. When a key press is not valid the CPN Series Chart Plotter will produce 2 beeps.

The key

- Pressing from any page in the Chart Plotter Mode opens the Main Menu.
- Pressing and holding for 3 seconds allows you to change the fields contained within the data windows.



- FROM THE STARTUP SCREEN PAGE ONLY: Pressing and holding for 5 seconds enables the Touchscreen Calibration mode.

The key

- When pressed, exits from a menu or from a selection, closes a Soft Key, changes from Cursor Mode to Home Mode or exits from a page to the Chart page.

The key

ACTIVE IN CHART PLOTTER MODE ONLY

- Press the  key to navigate or Goto a destination.
- When pressed, a popup window will be shown allowing you to start navigating to the position of the Cursor, a saved Mark, Route or ER (Easy Route).
- To stop navigation, press the  key and tap on **STOP**.



The key

ACTIVE IN CHART PLOTTER MODE ONLY



- Pressing the  key places a Mark under the ship's position when in Home Mode, or under the cursor's position.
- Pressing and holding for 3 seconds allows you to open the Marks/Waypoints List page.

The key

ACTIVE IN CHART PLOTTER MODE ONLY







- Pressing the  key places a Waypoint under the vessel's or cursor position.
- Move the cursor and press the  key to place additional Waypoints to form a Route.
- Pressing and holding for 3 seconds allows you to open the Edit Route page.

The ShuttlePoint knob (joystick)

- Moves the cursor around the Chart page (Cursor Mode) and pans the chart.
- Used to scroll and select menu items. The  ShuttlePoint knob also changes the CPN Series Chart Plotter from Home Mode to Cursor Mode on the chart screen.
- Pressing in on the  ShuttlePoint knob selects or enters a function (user selectable, ShuttlePoint Enter item in the Par. 2.1.4 "Settings in General Setup Menu")





The keys

ACTIVE IN CHART PLOTTER MODE ONLY

- Pressing the  key shows more detail of a smaller area, by changing the chart scale and zooming in on your display.
- Pressing the  key changes the chart scale and shows a wider, otherwise less detailed view.
- Pressing and holding the  or  key allows for quick zoom.
- The  or  key enables the rotary knob for zooming. Rotate the knob clockwise to Zoom In and counterclockwise to Zoom Out.



 For North America users only. The CPN Series Chart Plotters contain Built-In Charts for Alaska, Hawaii and Great Lakes, Canada, Bahamas, Caribbean, Cuba, Mexico, Puerto Rico, and Central America. For more detail, a C-MAP 4D SD CARD must be purchased and installed.

The Rotary knob

- Used to scroll and select menu items.
- Pressing in selects or enters a function.
- Used after pressing with the  or  key allows rotating or tilting the chart display both in 3D and in 2D mode.
- Used after pressing with the  or  key allows zooming.



The ROTATE key

ACTIVE IN CHART PLOTTER MODE ONLY

- To rotate the chart: press the  key, then rotate the  rotary knob. The rotate angle ranges from 0° to 359°.

The TILT key

ACTIVE IN CHART PLOTTER MODE ONLY

- To tilt the chart: press the  key, then rotate the  rotary knob. The tilt angle ranges from 90° to 11° (90° is the view from the top). Clockwise rotation increases the tilt angle, counterclockwise rotation decreases the tilt angle.

The CHART key



ACTIVE IN CHART PLOTTER MODE ON CHART PAGE ONLY

- Opens the CHART DISPLAY menu window from which you can select 2D Vector, Vector/Satellite, Raster or 3D Vector, Satellite or Raster modes.

 Optional C-MAP 4D cartography is needed to see Raster and Satellite details on the chart.

The MOB key

ACTIVE IN CHART PLOTTER MODE ONLY

- When pressed, places a MOB (MOB = Man Over Board) mark on the Chart page under the boat's position to aid in the rescue of a person who may have fallen aboard.
- To delete MOB, press the  key and then tap on  on the popup window.

The Intelligent key

- Exits the Chart Plotter Mode and shows a window to select the Internet Browser or play audio files, and to select Brightness and Touchscreen Calibration.
- IN CHART PLOTTER MODE ONLY: Playing music in background (see following Par. 1.3.2).

The PWR key (Brightness)

- Pressing and holding turns the CPN Series Chart Plotter On.
- Once On, pressing momentarily shows the display brightness adjustment window.
- To turn Off, press and hold until the Shut Down menu is shown, then tap on .
- IN CHART PLOTTER MODE ONLY: Allows to access touchscreen enabling/disabling functionality (see "Touchscreen Disabling" in the Par. 1.2.1 "Touchscreen").

1.3.2 PLAYING MUSIC IN BACKGROUND (CHART PLOTTER MODE ONLY)

It is possible to play audio files when in Chart Plotter Mode by pressing the **f** Intelligent key to access Media Player from the Chart Plotter Mode.

Once the Media Player is running as background application on the Chart Plotter Mode, the **f** Intelligent key can toggle between the Chart Plotter and Media Player and back.

! The Media Player is the only application that can be activated from the Chart Plotter Mode. It is not possible to enter the Internet Browser when the Media Player and the Chart Plotter are both active.

Starting music in background

To play music in background when in Chart Plotter Mode, follow the procedure below:

1. While Chart Plotter Mode is running, press the **f** Intelligent key. A popup window will allow you to choose the following options: Browser, Multimedia or Calibration.

2. Tap on Multimedia Player Icon  to open the Media Player.

3. Choose an album or song to play, adjust the play mode and volume (see Media Player section for more information).

4. Press the **f** Intelligent key to go back to Chart Plotter Mode. The Media Player is hidden but it is active (music is playing) and the Chart Plotter Mode is shown again.

Pressing the **f** Intelligent key toggles between Media Player and Chart Plotter Modes.

! Video can not be viewed when in Chart Plotter Mode, to watch videos press the **PWR** key and tap Startup Screen. From the Startup Screen tap Multimedia.

Stopping music in background

To stop playing in the background while in the Chart Plotter Mode, follow the procedure below:

1. While Chart Plotter Mode is running, press the **f** Intelligent key.

2. Tap on **X** in the top right corner to stop the currently selected song, tap on **X** again to close the Media Player and enter Chart Plotter Mode.

1.3.3 SOFT KEYS (CHART PLOTTER MODE ONLY)

The CPN Series Chart Plotters have Soft Keys which are shown on the display when:

- **Chart page**

The cursor is moved over the top of an item (Mark, Waypoint, Route, chart object¹...)

! Only if the Auto Info option is enabled, see Par. 2.1.4 "Settings in General Setup Menu".



- **Chart page**

Touch and hold the Page Change tab (refer to the image below) to show Soft Keys to access other pages.





- **Other Pages** (Tide, Highway, Compass, GPS and Fish Finder pages)

Tap anywhere on the page to show the Soft Keys:



Closing Soft Keys

The Soft Keys are closed in the following ways while in Chart Plotter Mode:

- Will automatically be removed if the display is not pressed for more than a specific timeout user selectable (see the Home Mode Revert item in the Par. 2.1.4 “Settings in General Setup Menu”).
- By tapping on the Close Soft key control .
- By pressing the  key.

1.4 MEMORY DEVICES SAFELY REMOVAL

To replace an SD CARD without chart data or a USB memory stick remove the device and wait at least 7 seconds before inserting the new one.

To remove an SD CARD with chart data during the CPN Series Chart Plotter working follow the procedure described in the Chart Plotter section (see Par. 2.3 “Removing the SD CARD”).

2 - CHART PLOTTER



2.1 GETTING STARTED

This section takes you through the most frequently used operations and shows how to customize the appearance of the CPN Series Chart Plotter.

1. Press the  PWR key until the display shows the Splash Screen page (see A). In case of error messages please refer to Par. 10.2 “System Update Error Messages”.



2. The Startup Screen page will be displayed in approximately 30-45 seconds (see B). This page allows you to select the Chart Plotter, Connection Manager, Internet Browser or Media Player modes.

3. To select the Chart Plotter Mode, tap on the Plotter Icon .

The CPN Series Chart Plotter will automatically change to Chart Plotter Mode if a key or display is not touched for 30 seconds.

4. The Splash Screen page (see A) is shown again before the Warning page appears (see C).

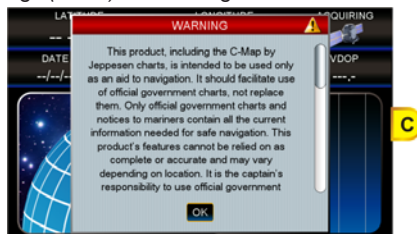

Move the  ShuttlePoint knob down or touch underneath the scroll bar to read the

Warning page. Tap on **OK** to accept the terms. Other Warning pages might appear, tap on **OK** to confirm.

! For North America users only: If Built-In Charts are out of date other Warning pages are displayed.

- When a CPN Series Chart Plotter is first turned on it will take some time for the GPS to acquire a fix of your position. During this time the GPS Status page (see *D*) will be shown. This page shows the signal strengths and locations of the GPS Satellites. After a fix is received the page will be changed to show the vessel's position on the Chart page (see *E*).

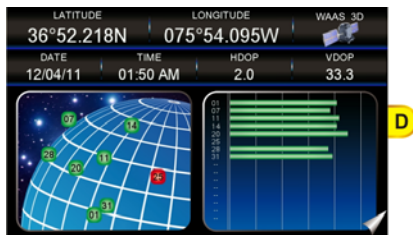

- After the Chart page is shown (see *E*), the vessel will be shown in the center of the display. CPN Series touch display operations:
 - Single tap: place the cursor
 - Pan (press and move finger): pan the chart to see a different area on the chart
 - Sweep (press and hold, then drag finger): change page

The **ShuttlePoint** knob when moved will change the location of the cursor. When the cursor reaches the edge of the chart, the chart will pan.

- When you move the **ShuttlePoint** knob you will notice DST and BRG values in the Cursor window change. This shows the Distance and Bearing from the GPS fix of your vessel to the position of the cursor.

2.1.1 SWITCHING BETWEEN MODES

Default Mode

The Chart page in 2D Vector is the default page. The Ship Icon (position fix) is in the center of the screen (Home Mode): as the ship moves through the water the vessel's position will be kept in the center of the display.

Home vs Cursor Mode

By default the CPN Series Chart Plotter shows the vessel in the center of the display which is called Home Mode. To change from Home Mode to Cursor Mode, touch the display or move the **ShuttlePoint** knob.

Cursor Mode

In Cursor Mode the Cross-Hair **+** is shown on the chart. To exit this mode so the Boat Icon stays in the center of the chart press the **CLEAR** key.

Cursor Mode allows you to pan around and look at areas on the chart. You can also create Marks, Routes, measure Distance and Bearing from your current position. The CPN Series Chart Plotter will automatically exit from Cursor Mode to Home Mode if the display or a key is not pressed for a user selectable time. The timeout depends on the Home Mode Revert setting in the General Setup menu (see Par. 2.1.4 “Settings in General Setup Menu”). Default is 1 minute.

Switching between 2D and 3D modes

There are two methods to toggle between 2D and 3D modes:

1 From Main Menu

1. The Chart page in 2D mode is shown (see A). Press the **MENU** key, tap on the large **Setup Menu** icon.
2. Tap on the small **DISPLAY** icon on the Desktop. The Chart Display menu appears (see B).

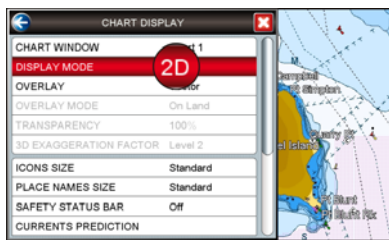
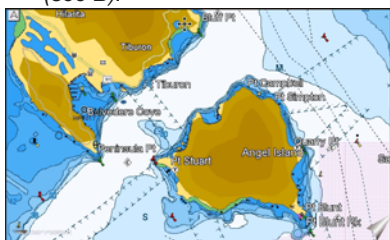

3. Tapping on **DISPLAY MODE** selects between **2D** and **3D**.
4. When 3D has been selected (see C), press the **CLEAR** key to exit from menu. The screen shows the Chart page in 3D (see D).

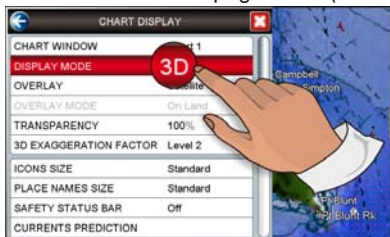

2 Using the **CHART** key

1. The Chart page in 2D mode is shown (see A).

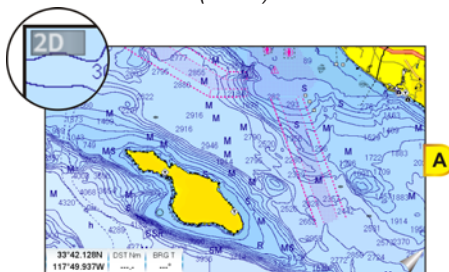

Press the **CHART** key: the following menu appears (see B).

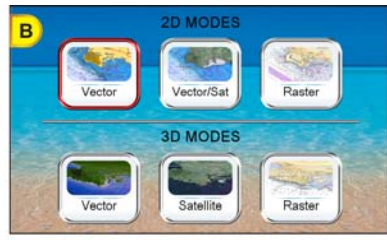
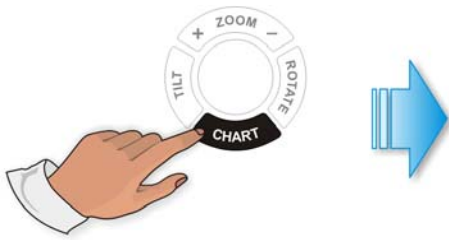

- To select the 3D mode tap on a desired 3D icon, 3D Vector, 3D Satellite, 3D Raster.
- As soon as the desired 3D icon has been tapped (see C), the screen shows the selected Chart page in 3D (see D).

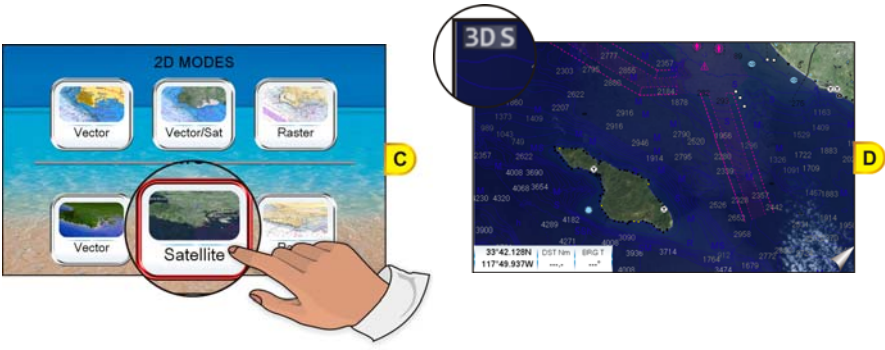

2.1.2 MENU SYSTEM

The CPN Series Chart Plotters have a unique menu system which allows you to select a page and see subpages on a desktop to make choices quick and easy. See the following examples of how to select a page:

1 Dual Chart example

- Press the **MENU** key from any page.
- Tap on the large **Chart** icon (see A) to select a page.
- Tap on the small **DUAL** icon (see B) on the Desktop to show the Dual Chart page (see C).



2 Setup Menu example

- Press the **MENU** key from any page.
- Tap on the large **Setup Menu** icon (see A) to select a page.

3. Tap on the small **GENERAL** icon (see B) on the Desktop to show the General Setup page (see C).



2.1.3 INITIAL SETUP

Cursor and Menu Selection Speed

The CPN Series Chart Plotter allows you to control the speed at which the cursor moves on the chart and in menus when using the ShuttlePoint knob. The default setting is Medium, to change the speed follow the procedure below:

1. Press the **MENU** key, tap on **Setup Menu** (see A).
2. Tap on **GENERAL** (see B). The General Setup menu appears (see C).



3. Tap on **CURSOR SPEED**. The menu now shows two selections, Chart and Menu which allow the Cursor Speed to be selected as High, Medium or Low on the Chart page or within the menus.
4. Tap on **CHART** or **MENU**.



5. Tap on **Low**, **Medium** or **High** to set the desired speed.
6. Press the **CLEAR** key repeatedly until the menu disappears.
7. Move the cursor on the Chart page and see if the speed is to your liking.

Changing the Ship Icon

The Ship Icon may be changed to one of the following icons for Sail or Power:



This setting also controls what type of a ship bow is displayed on the Highway page. The default setting is Power boat. To select the Ship Icon you want follow the procedure:

1. Press the **MENU** key, tap on **Setup Menu** (see A).
2. Tap on **DISPLAY** (see B). The Chart Display menu appears.
3. Move the **ShuttlePoint** knob down or turn the **Rotary knob** or touch underneath the scroll bar until **SHIP ICON** is selected (see C).



4. Tapping on **SHIP ICON** selects between **Power boat** and **Sail boat**.
5. When the item you want has been selected, press the **CLEAR** key to exit from the menu.

Selecting Course Up/North Up

The default selection is North Up: the chart is shown with North toward the top of the display. Also it is possible to select Course Up: the top of the Chart page orientated so it always shows the area ahead of the direction your vessel is travelling.

1. Press the **MENU** key, tap on **Setup Menu**.
2. Tap on **DISPLAY**. The Chart Display menu appears.
3. Move the **ShuttlePoint** knob down or turn the **Rotary knob** or touch underneath the scroll bar until **COURSE UP/NORTH UP** is selected.
4. Tap on **COURSE UP/NORTH UP** to toggle to the desired selection.
5. Press the **CLEAR** key or tap on **X** to save the selection.

Pages Selection

There are three methods to change a page:

1 From Main Menu

1. Press the **MENU** key, the Main Menu appears.
Tap on the desired page icon (in the following example **Navigation**, see A), the related Desktop icons appears.



2. Tap on the desired Desktop icon (in the example above **COMPASS**, see B). The Compass page appears (see C).

2 Sweep

1. Press and hold a finger on the display until a double arrow icon is shown (see A).

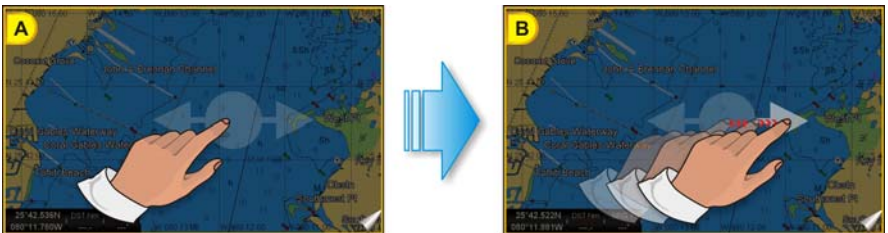

2. Without removing your finger, slide it to the left or to the right until the arrow turns white (see B), then remove your finger from the display to change to another page (see C and D).

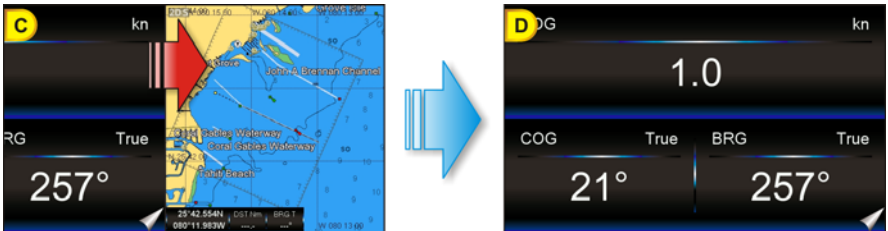

3 Page Change Tab

The Page Change tab  is displayed on every page and it is used for two actions:

- **Single tap:** changes to the next page. In the example below a single tap on the Page Change tab changes to the Compass page.



- **Long press:** displays the page Soft Keys. To change the page, tap on the desired Soft Key, refer to the image below: tap on the **COMPASS** Soft Key to change to the Compass page.



! The pages defined on the Soft Keys are used to define the page change cycle.

Assigning Page Soft Keys

The default pages are:



The page Soft Keys can be individually customized from the default pages:

1. To change, press and hold the Page Change tab  (see A) until Soft Keys are shown, then remove your finger.
2. Press and hold the page Soft Key you want to customize (see B). A popup window will be shown with the available pages (see C).



3. Touch the desired page to select and assign the page to the Soft Key.

Time Setup

The time information supplied by the GPS satellites is in Universal Time Coordinates (UTC or Greenwich Mean Time). To change the CPN Series Chart Plotter to read the correct time, first you must know the correct offset for your Time Zone, and then whether or not you are observing Daylight Saving Time. For example on the West coast of the United States or Pacific Standard Time the offset needed would be $-08:00$ or $-07:00$ for Daylight Saving Time, Eastern Standard Time $-05:00$ or $-04:00$ for Daylight Saving Time. The Time Setup menu allows you to enter a Time Zone offset for your location, selection to automatically

adjust the time for Daylight Saving and to configure the time in 12 or 24 hour formats.

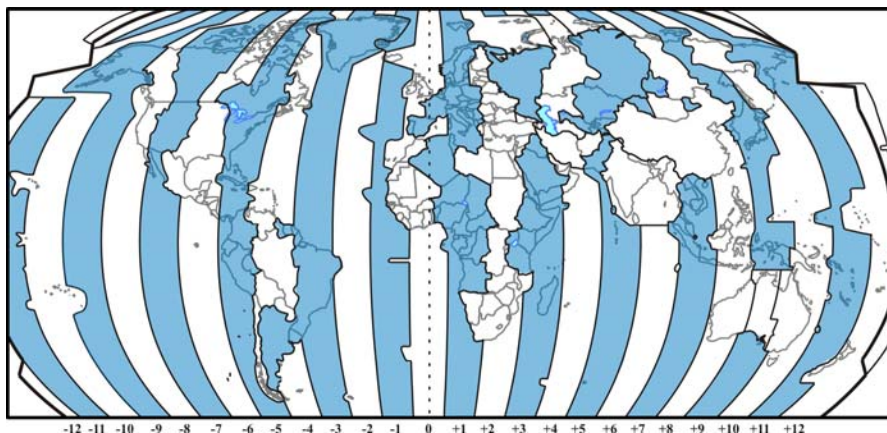

1. Press the **MENU** key, tap on **Setup Menu**.
2. Tap on **GENERAL**. The General Setup menu appears.
3. Tap on **TIME SETUP**. The Time Setup menu appears.



4. Tap on **TIME ZONE**.



5. Look at the table and find the time zone for your area. Tap under the bar (rotate the rotary knob or move the ShuttlePoint knob) to select the desired zone and tap on it.
6. Tap on **DAYLIGHT SAVING** to toggle between **Off** (select Off when your location does not recognize Daylight Saving Time) or **On** (select On to manually turn Daylight Saving Time On. On is the default selection).
7. Tap on **TIME FORMAT** to toggle between **12 hour** or **24 hour** (military) format.
8. Tap on **X** to exit the menu and show the last selected page.

By setting the time in the steps above, the time shown on the Tide page is automatically set up.

Selecting Coordinate System

GPS Coordinates may be changed to show Latitude/Longitude (default ddd.mm.mmm), Loran TDs or UTM. To change the Coordinate System, follow the procedure below:

1. Press the **MENU** key, tap on **Setup Menu**.
2. Tap on **ADVANCED**. The Advanced Setup menu appears.
3. Tap on **NAVIGATE**. The Navigate menu appears.
4. Tap on **COORDINATE SYSTEM**.

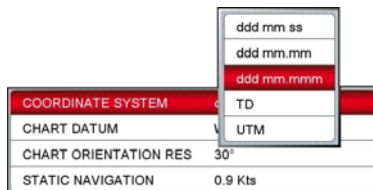

5. Tap on the desired coordinate type.
6. Press the **CLEAR** key 3 times to show the last selected page.

Loran TD

1. Press the **MENU** key, tap on **Setup Menu**.
2. Tap on **ADVANCED**. The Advanced Setup menu appears.
3. Tap on **NAVIGATE**. The Navigate menu appears.
4. Tap on **COORDINATE SYSTEM**.
5. Tap on **TD**.



6. Tap on **CHAIN** and turn the rotary knob to select the Chain then tap on the number.
7. Tap on **PAIR** and turn the rotary knob to select the Pair then tap on the letters.
8. Press the **CLEAR** key 3 times to show the last selected page.

ⓘ If the TD numbers are not show correctly on the Chart page, the Pair letters may be backwards. Reversing the two letters usually solves this issue. Example Y/Z changes to Z/Y.

Changing the Display Color

The CPN Series Chart Plotter has preprogrammed settings allowing you to customize the look of the pages. The default is Normal.

1. Press the **MENU** key, tap on **Setup Menu**.
2. Tap on **GENERAL**. The General Setup menu appears.
3. Tap on **DISPLAY COLOR**. A popup window will be shown with the available options **Normal**, **Classic**, **NOAA**, **Night** and **SunLight**.

- Normal
- Classic
- NOAA
- Night
- SunLight

DISPLAY COLOR Normal

4. Tap on the desired selection.
5. Tap on  to exit the menu and show the last selected page.

In the pictures A and B you can see examples of charts and Compass page with the Display Color set to Normal.



In the pictures C and D you can see the same examples with the Display Color set to SunLight.

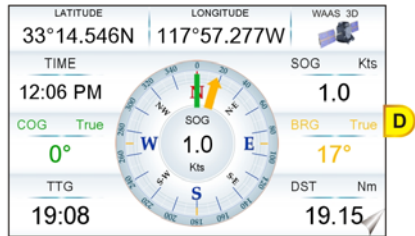
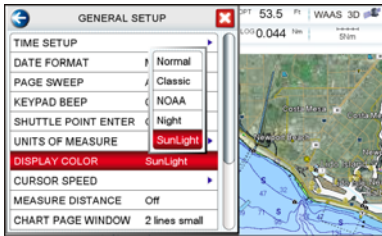

Selecting Language

To ease operation in different countries, the CPN Series Chart Plotters include translations in the following 16 languages:

- English
- German
- Swedish
- Danish
- Finnish
- Japanese
- Italian
- Spanish
- Portuguese
- Dutch
- Russian
- French
- Norwegian
- Chinese (Traditional)
- Greek
- Chinese (Simplified)

Multilanguage will display the digitized data in the charts as long as the source paper chart was done in the national language. For instance, if a Chinese chart is digitized in English, the digitized data will only display in English. However, if it was digitized in Chinese, then the digitized data can display Chinese or English. The translations are included in menus, data pages, warning/alarm messages, full/quick info, list of objects found by find/nearest function, and on charts (such as place's names and buoy's names and so on).

To select the language you want:

1. Press the **MENU** key, tap on **Setup Menu**.
2. Tap on **GENERAL**. The General Setup menu appears.
3. Move the **ShuttlePoint** knob down or turn the **rotary knob** or touch underneath the scroll bar until **LANGUAGE** is selected.
4. Tap on **LANGUAGE**. Another popup window will be shown with the available languages.



! To see additional languages, tap under bar or move the **ShuttlePoint** knob down or turn the **rotary knob**.

5. Tap on the desired language.
6. Tap on **X** to exit the menu and show the last selected page.

! If the selected language is not available on cartographic data, English is used.

Chart Control Icon

When the Chart page is selected a transparent icon (see A) is shown. This icon allows control of Zooming, Tilting, Rotating and controlling the Transparency and Exaggeration Factor¹ when optional C-MAP charts are used.

! Available in 3D mode only.

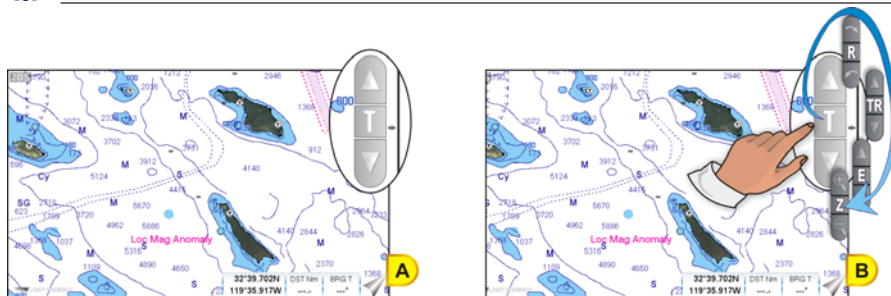

Tap on the center of the Chart Control Icon (see B) to toggle between the desired function, see the table below:

| ZOOM | TILT | ROTATE | TRANSPARENCY | EXAGGERATION FACTOR |
|------|------|--------|--------------|---------------------|
| Z | T | R | TR | E |

The Chart Control Icon display duration can be adjusted from Off, 2 sec, 5 sec, 10 sec and Permanent (default). If Off is selected the Chart Control Icon will not be displayed. If 2 sec, 5 sec, or 10 sec is selected the Chart Control Icon will be displayed for the selected duration. Tap the touch screen to make the Chart Control Icon reappear. To adjust the duration of the Chart Control Icon follow the procedure below:

1. Press the **MENU** key, tap on **Setup Menu**.
2. Tap on **GENERAL**. The General Setup menu appears.
3. Turn the rotary knob until **CHART CONTROL ICON** is highlighted.
4. Tap on **CHART CONTROL ICON**.
5. Tap on **SHOWN**.
6. The menu shows **Off, 2 sec, 5 sec, 10 sec** and **Permanent**. Tap on the desired duration.
7. Press the **CLEAR** key repeatedly until the menu disappears.

The Chart Control Icon can be adjusted from left side (default) of the Chart display to the right. To adjust the location of the Chart Control Icon follow the procedure below:

1. Press the **MENU** key, tap on **Setup Menu**.
2. Tap on **GENERAL**. The General Setup menu appears.
3. Turn the rotary knob until **CHART CONTROL ICON** is highlighted.
4. Tap on **CHART CONTROL ICON**.
5. Tap on **LOCATION** to select between **Left** and **Right**.
6. When the desired location has been selected, press the **CLEAR** key repeatedly until the menu disappears.

2.1.4 SETTINGS IN GENERAL SETUP MENU

The General Setup menu allows you to customize the display. All selections are listed in the following table:

| | |
|----------------------------|--|
| TIME SETUP | Selects the Time Zone offset, enables or disables Daylight Saving time, selects 12 or 24 hour Time Format . |
| DATE FORMAT | Selects the Date format MM-DD-YY (default), DD-MM-YY or YY-MM-DD . |
| PAGE SWEEP | Selects Animated (default), Normal and Off the page sweep control. |
| KEYPAD BEEP | Adjusts keypad beep On (default) or Off . |
| SHUTTLE POINT ENTER | ShuttlePoint knob press to enter is user selectable. When set to On (default), pressing the ShuttlePoint knob in the center will enter or confirm the action. When set to Off , pressing the ShuttlePoint knob in the center will not produce any effect. |
| UNITS OF MEASURE | Units of Measure can be selected for Distance, Speed, Wind Speed, Depth, Altitude, Temperature, Air Pressure, Oil/Boost Pressure and Fuel : Distance: selections are Nm (Nautical Miles), SM (Statute Miles), km (Kilometers), Nm+ft , Nm+m . Note when "Nm+ft" is selected if the distance is less than 1.0Nm, feet will be displayed. When "Nm+m" is selected if the distance is less than 1.0Nm, meters will be displayed. The default setting is Nm. Speed: selections are kn (knots), mph (miles per hour), km/h (kilometers per hour). The default setting is kn. Wind Speed: selections are kn (knots), m/s (meters per second), km/h (kilometers per hour), bft (Beaufort). The default setting is kn. Depth: selections are ft (feet), ftm (fathoms) and m (meters). The default setting is ft. Altitude: selections are ft (feet) and m (meters). The default setting is ft. Temperature: selections are °F (Fahrenheit) and °C (Celsius). The default setting is °F. Air Pressure: selections are bar and hPa . The default setting is hPa. Oil/Boost Pressure: selections are bar , psi and kPa . The default setting is kPa. Fuel: selections are l , UK gal and US gal . The default setting is US gal. |



DISPLAY COLOR

Changes the background colors to enhance the visibility of the screen depending on the surrounding light conditions. **Normal** (default) is recommended when the CPN Series Chart Plotter is not exposed to the direct sunlight. When this mode is set the charts are displayed in order to use colors as similar as possible to ones used in the original paper charts. **Night** is recommended when the environment is dark in order to reduce the glare of the display. **SunLight** is designed to enhance the visibility of the screen when the CPN Series Chart Plotter is exposed to sunlight. **Classic** uses vivid chart colors presentation. **NOAA** allows setting NOAA paper chart colors presentation.

CURSOR SPEED

Selects the speed of the cursor when navigating the CHART page or within the menus. **Low**, **Medium** (default) and **High**.

MEASURE DISTANCE

When this function is **On**, tap (or move the  ShuttlePoint knob) on a location where you want to start measuring a distance and press the  rotary knob (see A). Tap on a second location where you want to finish measuring a distance and press the  rotary knob. A line appears between the Start and Finish points and a popup window will be shown indicating the distance and bearing from the Start and Finish points (see B). Tap on the

DELETE Soft Key to delete both points. The default setting is **Off**.

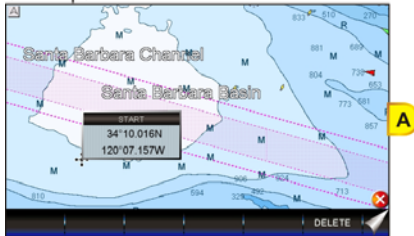
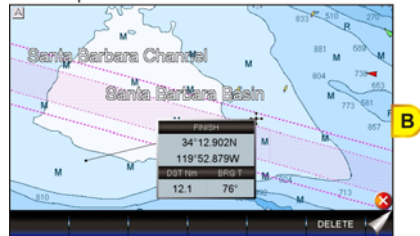
START point**FINISH point****CHART PAGE WINDOW**

Allows selection of data windows. Selections are **None**, **General**, **1 line small**, **1 line large** and **2 lines small** (default). The data windows may be customized (see "Customizing Data Windows" in the Par. 2.13.3 "Chart page") and may be collapsed or shown to show more or less chart area (see "Collapsing Data Windows" in the Par. 2.13.3 "Chart page").

LANGUAGE

Allows changing the language for menus and data screens. English is the default.

AUTO INFO

When the cursor is moved over a buoy, Mark or other item a popup window will show information about the item. This menu item allows the window to be turned **Off**, **On Points** (default) or **On All**.

HOME MODE REVERT

Sets the timeout (among **10 sec**, **30 sec**, **1 min** (default), **2 mins**, **5 mins** and **Off**) after which the CPN Series Chart Plotter goes back from Cursor Mode to Home Mode.

CURSOR WINDOW

By default when the cursor is moved on the chart a window is shown with the Lat/Lon Distance and Bearing from the vessels location to the cursor. This selection allows the window to be turned **On** (default) or **Off**. It appears only on the Chart pages (Single, Dual and Chart/Highway). The Cursor Window is automatically disabled when General is set in Chart Page Window option.

CHART CONTROL ICON

Opens a menu with two items:

SHOWN: the chart control touchscreen icon can be permanently shown (default) or it can be shown for a while (timeout) when the keyboard is touched. Select the timeout among **2 sec**, **5 sec**, **10 sec**, **Permanent** and **Off**. Note that if the Chart Control Icon has a timeout the icon reappears when you tap the chart.

LOCATION: the chart control touchscreen icon can be shown on the **Right** or **Left** (default) top side of the screen.

BUILT-IN CHARTS

FOR NORTH AMERICA USERS ONLY Enables (On) or disables (Off) the Built-In Charts. The default is On.

1. Press the **MENU** key, tap on **Setup Menu**.
2. Tap on the right arrow next to **ADVANCED** Desktop icon to display **ABOUT** and tap on it.
3. The About page appears on the screen, refer to the picture below:

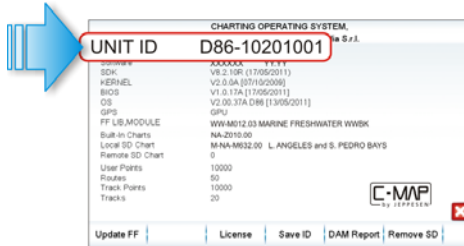

The Chart Update Card can be used **ONLY** on the CPN Series Chart Plotter with that UNIT ID code.

After purchasing the Chart Update Card, follow the procedure to update the charts.

1. Press the **PWR** key to turn the CPN Series Chart Plotter Off.
2. Insert the Chart Update Card into the slot.

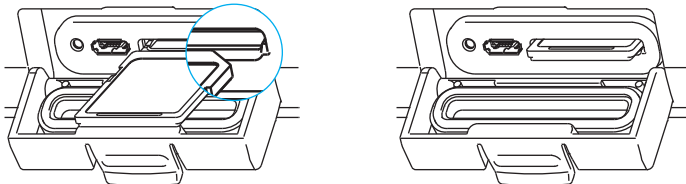

3. Press and hold the **PWR** key to turn the CPN Series Chart Plotter On.
4. The package update window appears (see A). The CPN Series Chart Plotter checks the integrity of the Installation Package present on the Chart Update Card. This operation might require several minutes (if you want to abort the installation tap on **EXIT**).

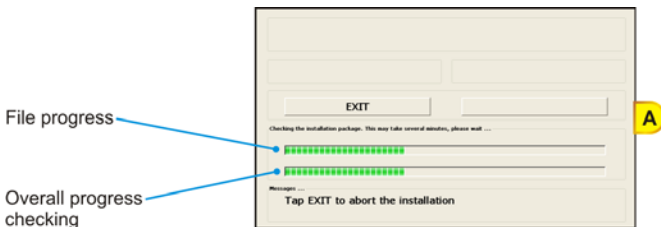

At the end of the checking, the package update window shows the following data (see B):

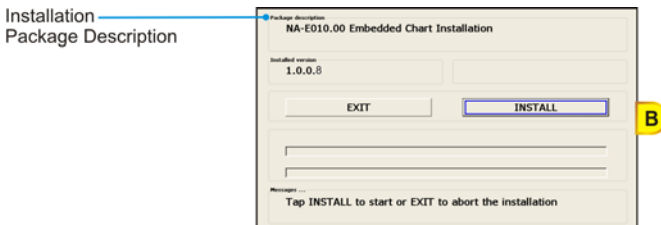



The **INSTALL** touchscreen key is now selected (it appears with blue frame).

- ❗ If case of error message, press the  PWR key to turn the CPN Series Chart Plotter Off and then follow steps 3-4 again. If the CPN Series Chart Plotter shows a error message again, contact C-MAP USA at (800) 424-2627 for assistance.

5. Tap on **INSTALL** to start installation (or tap on **EXIT** to abort).
6. The installation process begins. Pay attention: do not turn the CPN Series Chart Plotter Off during installation. The installation status appears in the two progress bars on the bottom of the package update window (see C):



7. At the end of the installation process, the Startup Screen page is shown.
8. To complete the Built-In Charts update procedure, press the  PWR key to turn the CPN Series Chart Plotter Off and remove the Chart Update Card from the slot.
9. Then press and hold the  PWR key to turn the CPN Series Chart Plotter On: the Built-In Charts are updated and ready to use.

- ❗ In case of error messages please refer to the *Par. 10.2 "System Update Error Messages"*.

C-MAP 4D

DIGITAL NAVIGATION CHARTS THAT GROW WITH YOUR BOATING NEEDS

To learn more go to <http://www.jepesen.com/C-MAP4D>

C-MAP 4D is the only maritime chart plotting solution that lets you completely customize your digital navigation charts and has the capability of adding new marine chart data as it becomes available.

First, choose either the **MAX** or **Full 4D** content on your cartridge. Should you start out with MAX and decide at a later date to upgrade to the Full 4D content, simply use the same cartridge to purchase and unlock the additional technology. C-MAP 4D allows you to unlock or add Value Added Data (to either MAX or Full 4D content) as they become available.

General Features

- **ISO Certification:** electronic chart production process with quality certification ISO 9001.
- **Official data source:** data based on use of official data sources Hydrographic Offices Release.
- **Detailed World Background:** worldwide background chart with details, satellite and 3D data on selected zoom ranges.

Data Features

- **Search & Find:** quickly locates chart contents and objects (Tide Station, Port Info, Port by Name, Wrecks, Obstructions, Lake name/info, POI).
- **Port Info:** searchable data base of service in Ports.
- **Object Info:** moving cursor over object to show restricted area details and related information.

- **Quick Info:** moving cursor over Wrecks, shoals, Nav-Aids to show restricted area details and related information and object to show details.
- **True-Type Font:** improves text on chart for optimal reading.

Presentation Features

- **Clear View:** advanced legibility techniques providing more chart data on the screen
- **Clear Info:** sophisticated "Human Dictionary" to translate Nav-Aid abbreviations found on paper charts.
- **Enhanced Mixing Levels:** seamless data presentation.

C-MAP 4D: MAX Content

- **Nav-Aids:** detailed information on Navigational Aids, including name, color, information on frequency, range of the light, etc.
- **Guardian Alarm:** user defined area in front of your vessel to alert you while navigating of possible obstacles on the chart. When activated, Guardian Alarm performs an automatic forward-scanning check for obstacles.
- **Safety Status Bar:** status bar with six boxes to show the status of certain functions. Any warning or alarm condition is identified by the red color to indicate possible risk.
- **Safe Route Check:** sophisticated function that checks for dangerous objects along your navigation route.
- **C-Marina Port Database:** complete Port and marina charts with detail.
- **Multilanguage capability:** allows showing language of your choice in using proper character set for Asian and other countries.
- **Tides Preview:** allows viewing of current, future and past Tide cycles from worldwide Tide Stations database.
- **Dynamic Currents:** current arrows showing speed and direction of current, future and past currents.
- **Photos & Diagrams:** high definition pictures of Ports, piers, bridge diagrams and Nav-Aids.
- **Depths & Land Elevation:** color shading of sea depth and land altitude for improved chart appearance.
- **Perspective View:** for a bird's-eye view of your navigation area.
- **Points Of Interest (POIs) and road mapping:** searchable data base of detailed information that include facilities and services in Ports and surrounding areas.

C-MAP 4D: FULL 4D Content

All above and in addition:

- **3 Dimensional Chart View:** the world has three dimensions. When you add the 4th dimension of time (meaning consistent, periodic updates) you combine the most detailed 3D height and depth worldwide database with a continuous update process to give you a personalized navigation experience with up-to-date data for safe navigation.
- **Satellite Images with 2D and 3D overlay:** C-MAP 4D includes a navigational perspective with high-resolution coastal imagery overlaid on the most accurate and up-to-date vector data, plus thousands of extraordinary photos for the most popular marinas and areas of interest.
- **Digital Raster Charts:** with raster charts, you have an additional reference source for navigational awareness. Get "at-a-glance" information using the nautical paper charts overlaid on 2D and 3D views on multi-dimensional shaded relief to have a new visual experience.

- **Easy Routing:** automatic creation of a Route. Enter start and end points along with specific boat parameters and automatically receive Waypoints of the shortest Route; highlights potential hazards and displays varying levels of alerts for each segment of the Route, allows you to manually adjust the Route.

C-MAP 4D: Value Added Data

New additional data or service to standard cartography available (High Resolution Bathymetry, etc). You can enable or disable the display of the category as a whole or of each individual.

- **High Resolution Bathy Charts & Spot Soundings:** data base with high resolution bathy information for an extraordinary view of the seabed depth.

2.2.2 VALUE ADDED DATA MENU

The VAD menu is a multiple options menu with the information present on the optional C-MAP 4D SD CARD. Value Added Data are divided into categories; inside each category there is a set of objects. Some of the VAD categories are free and some others have to be purchased. You can enable or disable the display of the category as a whole or of each individual object inside the category.

- each category has a separate submenu
- each category has a On/Off/Custom settings available:
 - **On** switches the display of all object in the category on
 - **Off** switches it off
 - **Custom** allows setting each object separately in the submenu

To select the VAD menu follow the procedure:

1. Press the **MENU** key, tap on **Setup Menu**.
2. Tap on **VAD**. The VAD menu appears on the screen.



2.3 REMOVING THE SD CARD

To safely remove the SD CARD follow the procedure:

1. Press the **MENU** key, tap on **Setup Menu**.
2. Tap on the right arrow next to ADVANCED Desktop icon two times to display **ABOUT**

- and tap on it. The About page appears on the screen.
3. Tap anywhere in the About page to display Soft Keys on the bottom of the page.
 4. Tap on the **REMOVE SD** Soft Key.
 5. Tap on **CONFIRM** in the popup window, then on **CLOSE** on the next window.
 6. Open the door, gently remove the SD CARD from the slot.
 7. Press the **CLEAR** key to exit.

2.4 USING FIND SERVICES

! This function finds only the cartographic objects which are been set to visible (On) in the menu.

It is possible to search the Built-In Charts¹ and the optional C-MAP 4D SD CARD² for Port Services, Ports, Tide Stations, Wrecks, Obstructions, Points Of Interest, Lakes, User Points, GPS Coordinates or Information on any point on the Chart.

! ¹ For North America users only.

! ² The amount of information might be due to the optional C-MAP 4D charts installed.

1. Press the **MENU** key, tap on **Chart**.
2. Tap on **FIND**. The Find Services & More menu appears.



! After the search is finished and a found object is located on the chart, if the CPN Series Chart Plotter was in 3D mode, it will automatically change to 2D mode.

2.4.1 PORT SERVICES

This feature is used to locate nearest Port Services to the position of your vessel. The following table shows a list of some of the available Port Services and icons shown on the Chart page:



1. Press the **MENU** key, tap on **Chart**.
2. Tap on **FIND**. The Find Services & More menu appears.
3. Tap on **PORT SERVICES**. A popup window will be shown with a list of different Port Services (see A).
4. Move the ShuttlePoint knob or touch the screen to highlight the desired type of service and tap on **SELECT**. Another popup window will appear displaying the distance and position of the Port Services closest to your location (see B). Otherwise tap on **CLOSE** to exit.



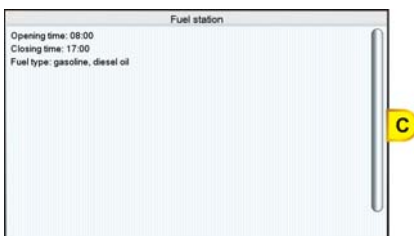

5. Use the ShuttlePoint knob to highlight the desired Port Service and tap on **FIND**. This will show information about the service (see C). Otherwise tap on **CLOSE** to exit.



6. Press the **CLEAR** key to show the actual position of the service on the Chart page.
7. Press the **CLEAR** key twice at any time to return your cursor to your vessel's position.

2.4.2 PORT

A Port is represented with a  on the Chart page. This feature is used to locate the 20 nearest Ports to the position of your vessel.

1. Press the **MENU** key, tap on **Chart**.
2. Tap on **FIND**. The Find Services & More menu appears.
3. Tap on **PORT**. A popup window will be shown with a list of nearest Ports (see A).
4. Move the  ShuttlePoint knob to highlight the desired Port and tap on it.
5. Tap on **FIND** to show the details of the Port (see B), otherwise tap on **PORT BY NAME** to search the Port by inserting the name. Tap on **CLOSE** to exit from Port function.

| NAME | DST [Nm] | BRG [T] |
|---------------------------------------|----------|---------|
| Horseshoe Bay Presidio Yacht Club | 4.733 | 65 |
| Horseshoe Bay Presidio Yacht Club | 4.733 | 65 |
| Richardson Bay Bayside Boatworks | 5.260 | 38 |
| Richardson Bay Bayside Boatworks | 5.260 | 38 |
| Richardson Bay Sausalito Cruise Club | 5.263 | 44 |
| Richardson Bay Sausalito Cruise Club | 5.263 | 44 |
| Richardson Bay Maritship Yacht Harbor | 5.266 | 41 |



| Objects | |
|---|--|
| Presidio Yacht Club | |
| Multimedia1112 | |
| 3d Height meters: 0 Name: Presidio Yacht Club Opening time: 00:00 Closing time: 00:00 Access: No Wake Zone Speed limit: 4 Knots Telephone number: 332.2319 Address: Fort Baker, 94966 P.O. box: 2726 E-mail: hg2706@stbcglobal.net Web site: www.presidoyc.org City: Sausalito | |

6. Press the **CLEAR** key twice at any time to return your cursor to your vessel's position.

2.4.3 TIDE STATIONS

A Tide Station is represented with a  on the Chart page. This feature is used to locate the 20 nearest Tide Stations to the position of your vessel. Once a Tide Station is selected the Tide Graph can be used to determine Tide height and draught of the Tide based on a user-specified time.

1. Press the **MENU** key, tap on **Chart**.
2. Tap on **FIND**. The Find Services & More menu appears.
3. Tap on **TIDE STATIONS**. A popup window will be shown with a list of nearest Tide Stations (see A).
4. Move the  ShuttlePoint knob to highlight the desired Tide Station and tap on it.
5. Tap on **FIND** to show the detail of the Tide Station (see B).
6. Press the **CLEAR** key at any time to return your cursor to your vessel's position.

| NAME | DST [Nm] | BRG [T] |
|-------------------------------|----------|---------|
| San Clemente | 29.14 | 30 |
| AVALON | 28.47 | 298 |
| NEWPORT BAY | 28.66 | 353 |
| Avalon, Santa Catalina Island | 28.70 | 297 |
| Balboa Pier, Newport Beach | 28.76 | 352 |
| Newport Bay Entrance, Coron. | 28.76 | 352 |
| LA JOLLA | 31.77 | 119 |
| La Jolla, Scripps Pier | 32.13 | 119 |
| Crown Point, Mission Bay | 35.89 | 125 |
| Queva Basin, Mission Bay | 36.47 | 126 |
| Los Patos (highway bridge) | 37.00 | 241 |
| WILSON COVE | 37.63 | 359 |

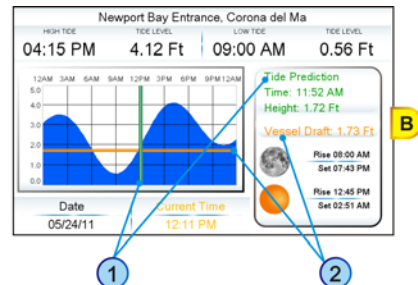
Refer to the image (B) above. Moving the ShuttlePoint knob left and right controls the Tide Prediction time ① and moving the ShuttlePoint knob up or down controls the Vessel Draft value ②.

! The Local Offset matches the Time Offset entered in the Time Setup menu.

Changing the day

1. Tap anywhere on the Tide page.
2. Tap on the **DATE** Soft Key (see C).
3. Enter the date using the touchscreen keyboard. When finished tap on , the keyboard disappears.

Changing Tide Station

1. Tap anywhere on the Tide page.
2. Tap on the **STATION** Soft Key (see C).
3. Tap on the desired Tide Station in the menu (see D).
4. Tap on **FIND** to show the new Tide information or tap on **CLOSE** to exit the menu.

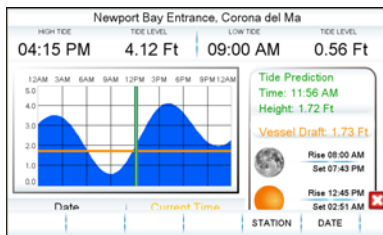



| NAME | DST [Nm] | BRG [° T] | Tide Level |
|------------------------------------|--------------|------------|------------|
| San Clemente | 20.14 | 30 | 0.56 Ft |
| AVALON | 28.47 | 288 | |
| NEWPORT BAY | 28.66 | 353 | |
| Avalon, Santa Catalina Island | 28.70 | 297 | |
| Balboa Pier, Newport Beach | 28.76 | 352 | |
| Newport Bay Entrance, Coron | 28.78 | 352 | |
| LA JOLLA | 31.77 | 119 | |
| La Jolla, Scripps Pier | 32.13 | 119 | |
| Crown Point, Mission Bay | 35.89 | 125 | |
| Quivira Basin, Mission Bay | 36.47 | 126 | |
| Los Patos (highway bridge) | 37.00 | 341 | |
| WILSON COVE | 37.63 | 259 | |

2.4.4 WRECKS

This feature is used to locate the 20 nearest Wrecks to the position of your vessel. A Wreck is represented with an icon on the chart, see the following table:

| ICON | DESCRIPTION |
|----------|---|
| ++ | non-dangerous wreck |
| ⊕ | dangerous wreck |
| # Four | distributed remains of wreck |
| ⊕+ Masts | wreck showing mast/masts |
| ✈ | wreck showing any portion of hull or superstructure |

1. Press the **MENU** key, tap on **Chart**.
2. Tap on **FIND**. The Find Services & More menu appears.
3. Tap on **WRECKS**. A popup window will be shown with a list of nearest Wrecks (see A).

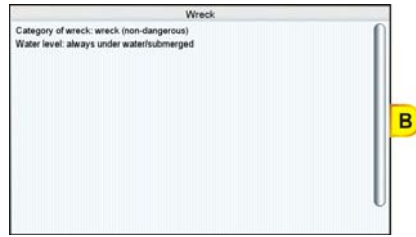

4. Move the  to highlight the desired Wreck or tap on it.
5. Tap on  to show the location of the Wreck (see B).
6. Press the  key twice to revert to your vessel's position.





2.4.5 OBSTRUCTIONS

This feature is used to locate the 20 nearest Obstructions to the position of your vessel. An Obstruction is represented with an icon on the chart, see the following table:

| ICON |  |  |  |  |  |  |  |  |  |  |
|--------|---|---|---|---|---|---|---|---|---|---|
| DESCR. | snag / stump | wellhead | diffuser | crib | fish haven | foul area | foul ground | ice boom | ground tackle | |

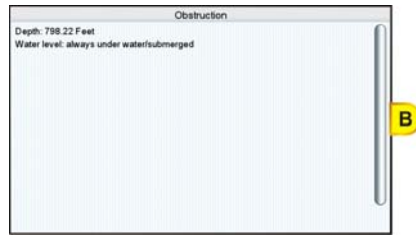
1. Press the  key, tap on **Chart**.
2. Tap on **FIND**. The Find Services & More menu appears.
3. Tap on **OBSTRUCTIONS**. A window is shown with a list of nearest Obstructions (see A).
4. Move the  to highlight the desired Obstruction or tap on it.
5. Tap on  to show the location of the Obstruction (see B).



6. Press the  key twice to revert to your vessel's position.

2.4.6 LAKES INFORMATIONS

A Lake Info is represented with a  on the Chart page. This feature is used to find information on the 20 nearest Lakes to the position of your vessel.

1. Press the  key, tap on **Chart**.
2. Tap on **FIND**. The Find Services & More menu appears.
3. Tap on **LAKES INFORMATION**. A window is shown with a list of Outdoor Recreational

Area objects (see A).

4. Tap on the desired object and tap on **SELECT**. A window appears displaying the distance and position of the Lakes closest to your location (see B).



5. Move the ShuttlePoint knob to highlight the desired Lake or tap on it.
6. Tap on **FIND** to show the location of the Lake (see C).



7. Press the **CLEAR** key twice to revert to your vessel's position.

2.4.7 QUICK AND FULL INFO ON LAKES

Upon viewing the chart of a lake, you can tap on the Lake Info icon (see A) to query the available information immediately displayed with many details. When the cursor is placed over this icon (and the Auto Info option is allowed) the Quick Info window appears: the icons of the available services are shown (see B).

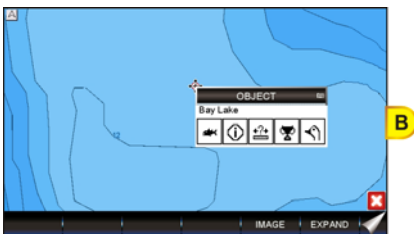

To see the "Fishing" object tap on the **IMAGE** Soft Key (see C). Tap on the **EXPAND** Soft Key to obtain the Full Info on Lakes: all available information about the cartographic point under the cursor will be shown (see D).

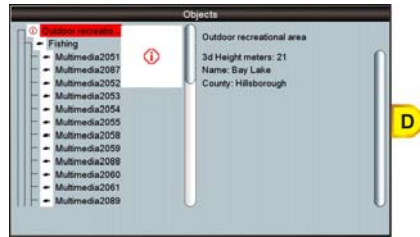
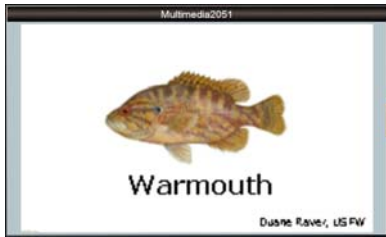

2.4.8 LAKES BY NAME

This feature is used to locate nearest Lakes By Name to the position of your vessel.

1. Press the **MENU** key, tap on **Chart**.
2. Tap on **FIND**. The Find Services & More menu appears.
3. Tap on **LAKES BY NAME**. A window will be shown with a list of nearest Lakes (see A).

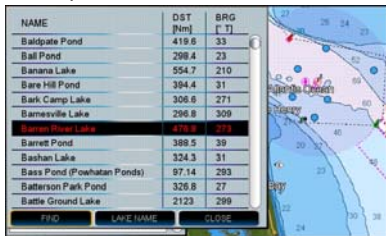

Now you can browse the list (step a) or enter the Lake name (step b):

- a. Browse the list and tap on the desired Lake.
 - b. Tap on **LAKE NAME** to enter the desired Lake name. The touchscreen keyboard appears, it will allow you to enter in the name of the Lake you wish. Insert the desired name; when finished tap on **↩**, the keyboard disappears. Another window will appear displaying the distance and position of the Lake. Tap on the desired Lake.
4. Tap on **FIND** to show the Information on the Lake (see B). Tap on the **IMAGE** Soft Key or on the **EXPAND** Soft Key to obtain the Full Info on Lakes: all available information about the cartographic point under the cursor will be shown.

2.4.9 POINTS OF INTEREST

This feature is used to locate nearest Points Of Interest (POIs) to the position of your vessel.

1. Press the **MENU** key, tap on **Chart**.
2. Tap on **FIND**. The Find Services & More menu appears.
3. Tap on **POINTS OF INTEREST**. A (Category) popup window will be shown with a list of Category types (i.e. attractions, emergency, entertainment).
4. Tap on the desired Category. A (Type) popup window will be shown with a list of types (see A).
5. Tap on the desired Type. A popup window will be shown with a list of nearest Points Of Interest that fall into the Category and Type you have selected (see B).

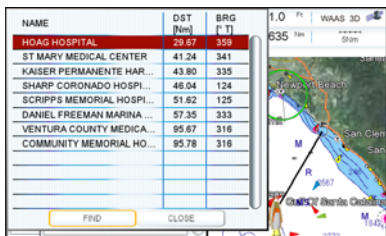

6. Tap on the desired Point Of Interest.
7. Tap on **FIND** to show the location of the Point Of Interest information (see C).

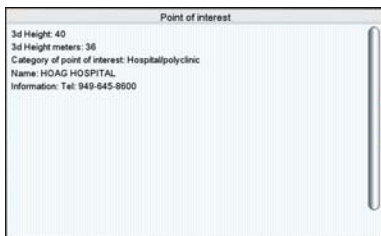

8. Press the **CLEAR** key twice to revert to your vessel's position.

2.4.10 USER POINTS

This feature is used to search for User Points (Marks and Waypoints you have created and stored) by name quickly and efficiently.

1. Press the **MENU** key, tap on **Chart**.
2. Tap on **FIND**. The Find Services & More menu appears.
3. Tap on **USER POINTS**. The touchscreen keyboard appears, it will allow you to enter in the name of the User Point you wish to locate. Insert the desired name; when finished tap on **↩**, the keyboard disappears. The screen shows the location of the User Point on the Chart page.
4. Press the **CLEAR** key twice to revert to your vessel's position.

2.4.11 COORDINATES

This feature allows you to enter Coordinates (Latitude/Longitude) and view the entered position on the Chart page.

1. Press the **MENU** key, tap on **Chart**.
2. Tap on **FIND**. The Find Services & More menu appears.
3. Tap on **COORDINATES**. The touchscreen keyboard appears, it will allow you to enter in a specified Latitude and Longitude. Once the Coordinates are entered tap on **↩**, the keyboard disappears. The screen shows the desired location on the Chart page.
4. Press the **CLEAR** key twice to revert to your vessel's position.

2.4.12 INFORMATION

This feature allows you to obtain information on any position on the Chart page.

1. Press the **MENU** key, tap on **Chart**.
2. Tap on **FIND**. The Find Services & More menu appears.
3. Turn the **rotary knob** to select **INFORMATION**.
4. Tap on **INFORMATION** to show the page below:

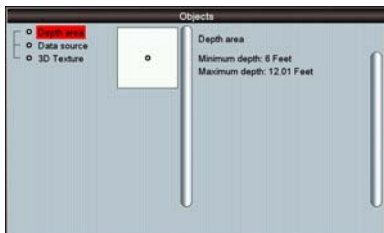

The left side of the page contains the Info Tree and the right side contains the expanded information. While tapping on the left side page moving through the Info Tree, all the relevant information of the selected object is shown on the right part of the page.

5. Press the **CLEAR** key 3 times to exit to the Chart page.

2.5 CHART DISPLAY FUNCTIONS

The Chart functions menu can be accessed using the Main Menu as shown below:

1. Press the **MENU** key, tap on **Setup Menu** (see A).
2. Tap on **DISPLAY** (see B). The Chart Display setup appears (see C) divided in two sections, one related to the 4D functions and another for generic chart display.



2.5.1 4D FUNCTIONS

Chart Window

This function selects the window that will be affected by the 4D related settings (see the following paragraphs). Each chart window has its own settings so, when Chart Window item is changed, all relevant settings are updated accordingly. The two available selections are Chart1 (default, applies to Single Chart and to the left chart window in Dual Chart) and Chart2 (applies to the right chart window in Dual Chart).

To activate this function follow the procedure:

1. Press the **MENU** key, tap on **Setup Menu**.
2. Tap on **DISPLAY**. The Chart Display menu appears.
3. Tapping on **CHART WINDOW** selects between **Chart1** or **Chart2**.
4. Once the window is selected the options can be set for that chart. Tap on **X** to exit from menu.

Display Mode

This function allows toggling among the (default) 2D (see A) and 3D (see B) modes to display the chart on the screen. To activate this function follow the procedure:

DISPLAY Mode 2D



A

DISPLAY Mode 3D

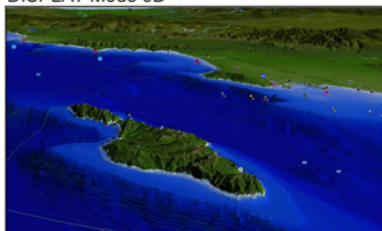

B

1. Press the **MENU** key, tap on **Setup Menu**.
2. Tap on **DISPLAY**. The Chart Display menu appears.
3. Tapping on **DISPLAY MODE** selects between **2D** or **3D**.
4. When the item you want has been selected, tap on **X** to exit from menu.

Overlay

This function allows to overlay Vector (default) (see A), Satellite image (see B), Raster Charts (see C) or Chart Shading¹ (see D) for background charts.

DISPLAY MODE 2D OVERLAY Vector



A

DISPLAY MODE 2D OVERLAY Satellite



B

DISPLAY MODE 2D OVERLAY Raster Charts



C

DISPLAY MODE 2D OVERLAY Chart Shading



D

To activate this function follow the procedure:

1. Press the **MENU** key, tap on **Setup Menu**.
2. Tap on **DISPLAY**. The Chart Display menu appears.
3. Tap on **OVERLAY**.
4. The menu shows **Satellite**, **Raster Charts**, **Chart Shading** or **Vector**. Tap on the item you want.
5. Tap on **X** to exit to the Chart page.

! Chart Shading is available only in Display Mode 2D.

Overlay Mode

This function sets the overlay area of Satellite and Raster images. To activate this function follow the procedure:

1. Press the **MENU** key, tap on **Setup Menu**.
2. Tap on **DISPLAY**. The Chart Display menu appears.
3. Tap on **OVERLAY MODE**.
4. The menu shows **On Land** (default), **On Sea** and **On All**. Tap on the item you want.
5. Tap on **X** to exit to the Chart page.

Transparency

This function sets the transparency value between the vector chart and the layer over it (raster or satellite). To activate this function follow the procedure:

1. Press the **MENU** key, tap on **Setup Menu**.
2. Tap on **DISPLAY**. The Chart Display menu appears.
3. Tap on **TRANSPARENCY**.

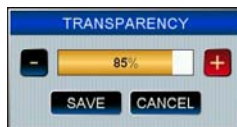

4. A new window appears to insert the desired value (0 - 100). Tap on **-** or **+** to reach the desired value, then tap on **SAVE** (tap on **CANCEL** otherwise). You can use the **rotary knob** to cycle between bar, **SAVE** or **CANCEL**.

! Available only if Overlay is Satellite or Raster Chart.

3D Exaggeration Factor

This function vertically stretches the land elevations and depths. It sets the 3D Exaggeration Factor among 5 levels (Level2 is the default). To activate this function follow the procedure:

1. Press the **MENU** key, tap on **Setup Menu**.
2. Tap on **DISPLAY**. The Chart Display menu appears.
3. Tap on **3D EXAGGERATION FACTOR**.
4. The menu shows **Level1**, **Level2**, **Level3**, **Level4** and **Level5**. Tap on the item you want.
5. Tap on **X** to exit to the Chart page.

! Available only in 3D mode.

2.5.2 GENERAL CHART DISPLAY FUNCTIONS

Icons Size

It is possible to set the size of all icons drawn on the charts, selecting between Standard (default) or Large size. To activate this function follow the procedure:

1. Press the **MENU** key, tap on **Setup Menu**.
2. Tap on **DISPLAY**. The Chart Display menu appears.
3. Tapping on **ICONS SIZE** selects between **Standard** or **Large**.
4. When the item you want has been selected, tap on **X** to exit from menu.

ICON SIZE Standard

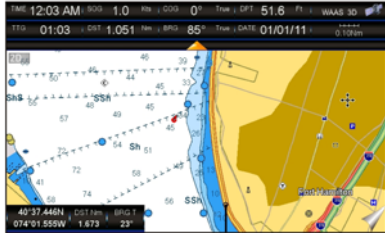

ICON SIZE Large

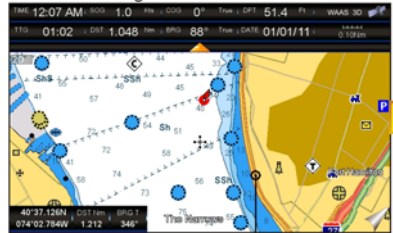

Place Names Size

It is possible to set the size of all names drawn on the charts, selecting between default Standard (see A), Medium (see B) and Large (see C) size.

PLACE NAMES SIZE standard

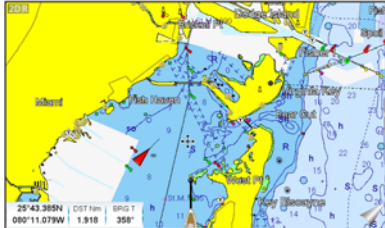

PLACE NAMES SIZE medium



PLACE NAMES SIZE large

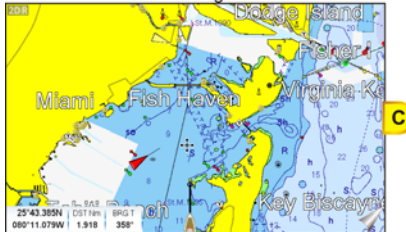

To activate this function follow the procedure:

1. Press the **MENU** key, tap on **Setup Menu**.
2. Tap on **DISPLAY**. The Chart Display menu appears.

- Tap on **PLACE NAMES SIZE**.
- The menu shows **Standard**, **Medium** or **Large**. Tap on the item you want.
- Tap on **X** to exit to the Chart page.

Safety Status Bar (DSI - Data Safety Indicator)

When the Safety Status Bar is enabled, a status bar with six boxes shows the status of certain functions. Any warning or alarm condition is identified by the red color to indicate possible risk.



1 **Normal:** when the chart is displayed at normal scale.

U. Zoom: red when the chart is under-zoomed out more than twice normal scale, gray otherwise.

O. Zoom: red when the chart is over-zoomed in more than twice normal scale, gray otherwise.

No Chart: red when the chart is zoomed in more than twice normal scale, gray otherwise.

2 Red when a more detailed chart is available under the cursor position.

3 Red when at least one of the following objects or layers is turned off (by the user) Depths/soundings; Wrecks/obstructions; Tracks/routes; Attention Areas; Nav-Aids.

4 Displays red when clearing overlapping objects.

5 Red when "Guardian Technology" detects one of the following objects: Land, Intertidal, Depth Area, Rocks, Obstructions, Shoreline Constructions, Fishing Facility, Wrecks, Draggled area, Diffusion area, Mooring facilities, Pings and Production installations.

6 Red when "Guardian Technology" detects cautionary or restricted area.



To activate this function follow the procedure:

- Press the **MENU** key, tap on **Setup Menu**.
- Tap on **DISPLAY**. The Chart Display menu appears.
- Tap on **SAFETY STATUS BAR**.
- The menu now shows the following selections:
 - On:** The Safety Status Bar is shown
 - Off:** The Safety Status Bar is not shown (default)

Icon: In this mode the Safety Status Bar is not shown, rather a Warning Icon  will be shown in the top right corner on the Chart page when an alarm condition is met.

- Tap on the desired selection.
- Tap on **X** to exit to the Chart page.

Currents Prediction

This feature only operates in areas where tidal buoys are present and when the CPN Series Chart Plotter has a GPS fix. Tidal stream arrows are shown on the charts, indicating the direction and strength of the Tide:



The color of the arrow denotes the strength of the current as follows:

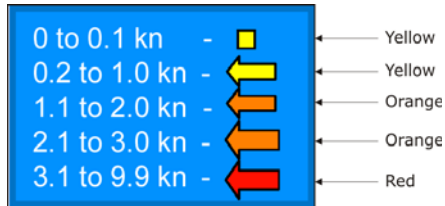

When the CPN Series Chart Plotter receives a valid position fix, the Tide icons are shown on the charts on the basis of the current date and time: the screen displays and changes arrows as date/time changes.

It is possible to see the variation of the Tidal arrows on the selected area at any given time.

To activate this function follow the procedure:

1. Press the **MENU** key, tap on **Setup Menu**.
2. Tap on **DISPLAY**. The Chart Display menu appears.
3. Turn the **rotary knob** to select **CURRENTS PREDICTION**.
4. Tap on **CURRENTS PREDICTION**.
5. Tap on the **SET TIME** Soft Key to set the date and time manually, and on the **INCR. TIME** / **DECR. TIME** Soft Keys to increase/decrease time; tap on the **EXIT** Soft Key to exit.

Chart Language

The CPN Series Chart Plotter may be customized to show the local language of the chart. To select the Chart Language you want:

1. Press the **MENU** key, tap on **Setup Menu**.
2. Tap on **DISPLAY**. The Chart Display menu appears.
3. Turn the **rotary knob** to select **CHART LANGUAGE**.
4. Tap on **CHART LANGUAGE**. A new window will appear with available functions described in the table.

Language : Allows setting the language to display chart information. The language is chosen from the list of languages available on the cartographic data (data cartridge or embedded charts).

Mode : Defines how objects are translated. Selections are:
 Off : Enables the language chosen in the Language menu above. If the selected language is not present on the objects information, English is used.
 English: Always uses English.
 Local : Uses the Local language present on C-MAP BY JEPPESEN SD CARD. If no Local language is available, English is used.

5. Tap on **X** to exit to the Chart page.



- a. When the Chart Language is changed, the following settings are automatically selected: MODE is set to Off and Chart Language is set to your selection.
- b. If the SD CARD is removed or changed, the Chart Language should be confirmed and changed if necessary.

Course Up/North Up

The default selection is North Up: the chart is shown with North toward the top of the display. Also it is possible to select Course Up: the top of the Chart page orientated so it always shows the area ahead of the direction your vessel is travelling.

1. Press the **MENU** key, tap on **Setup Menu**.
2. Tap on **DISPLAY**. The Chart Display menu appears.
3. Turn the **rotary knob** to select **COURSE UP/NORTH UP**.
4. Tapping on **COURSE UP/NORTH UP** selects between **North Up** and **Course Up**.
5. When the item you want has been selected, tap on **X** to exit to the Chart page.

Nav-Aids Presentation

Allows the Nav-Aids Presentation to be drawn using NOAA symbology when **US** (this is the default setting if Built-In Charts¹ is available) is selected or International symbols when **International** (this is the default setting if Built-In Charts¹ is not available) is selected. When selected these functions affect how the icons for Lights, Signals, Buoys and Beacons are displayed.

To activate this function follow the procedure:

1. Press the **MENU** key, tap on **Setup Menu**.
2. Tap on **DISPLAY**. The Chart Display menu appears.
3. Turn the **rotary knob** to select **NAV AIDS PRESENTATION**.
4. Tapping on **NAV AIDS PRESENTATION** selects between **US** and **International**.
5. When the item you want has been selected, tap on **X** to exit to the Chart page.



¹ For North America users only.

Ship Icon

This setting controls the type of a ship icon drawn on the Chart page and the ship bow displayed on the Highway page, and also sets the fix icon type displayed on the Chart pages. The default setting is Power boat. See the following examples of Ship Icons:



To select the Ship Icon you want follow the procedure:

1. Press the **MENU** key, tap on **Setup Menu**.
2. Tap on **DISPLAY**. The Chart Display menu appears.
3. Turn the **rotary knob** to select **SHIP ICON**.
4. Tapping on **SHIP ICON** selects between **Power boat** and **Sail boat**.
5. When the item you want has been selected, tap on **X** to exit to the Chart page.

Course Time Line

The Course Time Line is a line projected from the ship icon which indicates the distance your vessel will travel at the current speed. Selections are 2, 10 (default), 30 minutes, 1, 2 hours and Infinite.

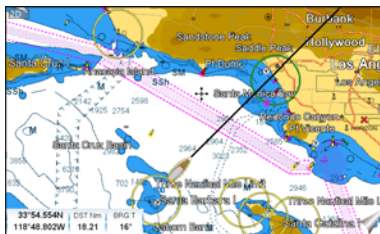

To activate this function follow the procedure:

1. Press the **MENU** key, tap on **Setup Menu**.
2. Tap on **DISPLAY**. The Chart Display menu appears.
3. Turn the **rotary knob** to select **COURSE TIME LINE**.
4. Tap on **COURSE TIME LINE**.
5. Tap on the item you want.
6. When the item you want has been selected, tap on **X** to exit to the Chart page.

Compass Indicator

Allows selection of compass direction indication around ship icon. The default is Off.



To activate this function follow the procedure:



1. Press the **MENU** key, tap on **Setup Menu**.
2. Tap on **DISPLAY**. The Chart Display menu appears.
3. Turn the **rotary knob** to select **COMPASS INDICATOR**.
4. Tapping on **COMPASS INDICATOR** selects between **On** or **Off**.
5. When the item you want has been selected, tap on **X** to exit to the Chart page.

Ship Icon Position

The position of the ship icon can be customized so it is centered in the middle (if **Center** selected, default setting) or centered on the bottom of the Chart page (if **Bottom** selected). It applies only to Home Mode.

To activate this function follow the procedure:

1. Press the **MENU** key, tap on **Setup Menu**.
2. Tap on **DISPLAY**. The Chart Display menu appears.



3. Turn the  rotary knob to select **SHIP ICON POSITION**.
4. Tapping on **SHIP ICON POSITION** selects between **Center** and **Bottom**.
5. When the item you want has been selected, tap on  to exit to the Chart page.

2.5.3 PICTURES & DIAGRAMS

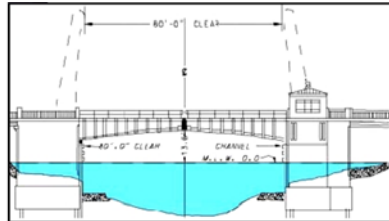
Using optional C-MAP by JEPPESEN data SD CARDS allows you to show pictures or diagrams on the CPN Series Chart Plotter display. These *Pictures* are typically used to facilitate the identification of cartographic objects or places around the map: they can be the landscape layout nearby a harbor, the shape of a bridge or of a buoy etc. On some objects, such as bridges, the image associated can represent the *Diagram* representing the shape of the objects and the various characteristics (length, height, type of bridge etc.).



How to show Pictures or Diagrams of an Object

They are shown on the Chart page with the camera icon  (see A). Move the cursor over the camera icon by tapping on the display or using the  ShuttlePoint knob. An Object's popup window will be shown (see B).



Tap on the **IMAGE** Soft Key to display the image on the screen (see C) or tap on the **EXPAND** Soft Key to open the Full Info on the object (see D).

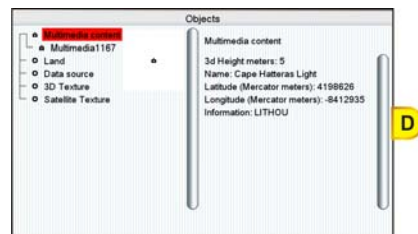

Note that on the Full Info, a small camera icon is shown. To see the picture tap on the **IMAGE** Soft Key when the object with a picture is highlighted. When the picture is shown, tapping on it shows the associated Soft Keys. If there are more pictures to show, there will be **NEXT** and/or **PREVIOUS** Soft Keys. Tap on the **CLOSE** Soft Key to exit, otherwise tap on **X** and the Soft Keys will disappear.

2.6 CREATING MARKS

A User Point is an object that you can place on the charts to mark a specific point. The CPN Series Chart Plotter features two types of User Points: Marks and Waypoints.

- A Mark can be a standalone position or be linked to a Route. A Mark is placed on the Chart page using the **MARK** key or by entering information in the Marks/Waypoints List page and tapping on **NEW MARK**.
- Waypoints are always linked to a Route. They are placed on the Chart page using the **ROUTE** key.

- ❗ The difference between a Mark and a Waypoint is:
- a. when a Route is created using Waypoints and the Route is deleted the Waypoints are also deleted.
 - b. if a Route is created using Marks and the Route is deleted the Marks remain.
-

2.6.1 CREATING A NEW MARK ON THE CHART PAGE

1. Move the **ShuttlePoint** knob or tap the screen at the desired or approx. Lat/Lon and press the **MARK** key.
2. You will notice a Mark is placed under the location of the cursor and a popup window is shown with the exact Lat/Lon of the Mark.
3. If the position is incorrect, tap on the **EDIT** Soft Key which allows changing of the position, Mark name and icon type by tapping on the position, Mark name or icon.

- 1 Mark placed under Cursor
- 2 Lat/Lon of Mark, DST/BRG from vessel location
- 3 Soft key to delete, to move, to edit a Mark or to show the Marks/Waypoint List (Directory)



- ❗ After entering in all the Marks it is a good practice to backup the points to a SD CARD.
-

2.6.2 EDITING A MARK OR WAYPOINT

1. Tap on the Mark or Waypoint you want to edit.

2. Tapping on the **EDIT** Soft Key shows the Mark Edit popup window.

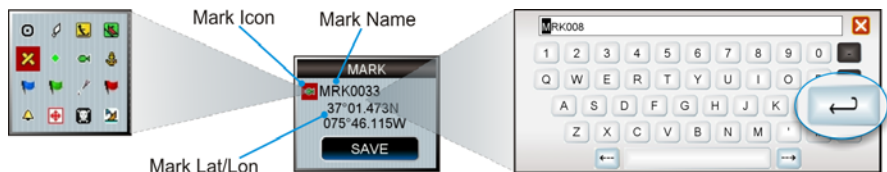

3. The Mark Icon appears selected, tap on it. The Mark Icons popup window appears.
4. Tap on the desired Mark Icon to select it. The Mark Icons window disappears.
5. Tap on the Mark Name. The touchscreen keyboard appears. Insert the desired name; when finished tap on **↩**, the keyboard disappears.
6. Tap on the Lat/Lon field. Again the touchscreen keyboard appears. Insert the desired coordinates; when finished tap on **↩**, the keyboard disappears.
7. Tap on **SAVE** to store the Mark.

2.6.3 DELETING A MARK OR WAYPOINT

1. Tap on the Mark or Waypoint you want to delete.
2. Tap on the **DELETE** Soft Key. A warning popup window will be shown to confirm deleting the point.

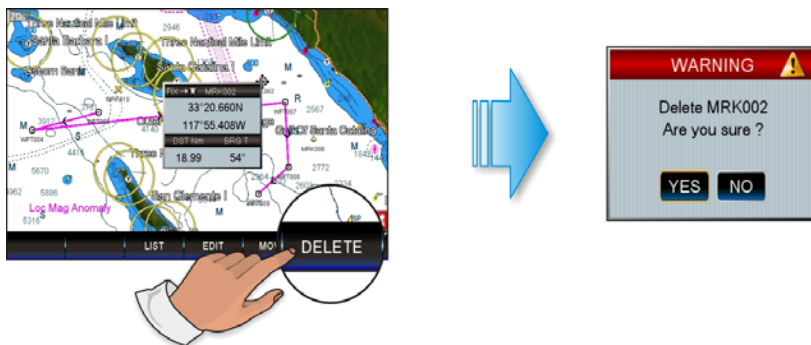

3. Tap on **YES** to confirm.

2.6.4 MOVING A MARK OR WAYPOINT

1. Tap on the Mark or Waypoint you want to move (see A).



2. Tap on the **MOVE** Soft Key.
3. Use the **ShuttlePoint** knob to move the cursor. A dotted line, connecting the previous Mark or Waypoint position to the new position, is shown (see B).
4. Tap on the new position (the **CLEAR** key to abort the move), the Mark or Waypoint appears (see C).

There is also an easier way to start moving a Mark or Waypoint: press the **MARK** or the **ROUTE** key while cursor is over a Mark point or a Waypoint. Then tap on the desired position and press the **ShuttlePoint** knob.

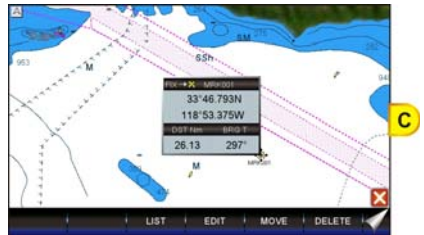
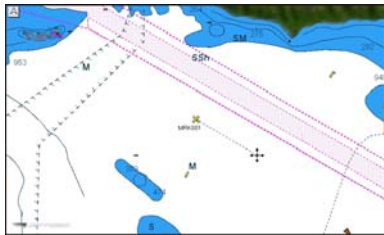

If the CPN Series Chart Plotter was in 3D mode, it will automatically change to 2D mode and remain there after the change has been made.

2.6.5 MARKS/WAYPOINTS (USER POINTS) LIST

The Marks/Waypoints List page shows all the Marks and Waypoints that have been stored into the CPN Series Chart Plotter. To show the User Points List:

1. Press the **MENU** key, tap on **User Points**.
2. Tap on **MARKS**. The Marks/Waypoints List page will be shown.

| MARKS / WAYPOINTS | | | | | | |
|-------------------|---------|------|------------|-------------|---------------|-------|
| SYM | NAME | TYPE | LATITUDE | LONGITUDE | DIST(NM) | MODE |
| ✳ | CKK003 | MARK | 33°08.842N | 118°30.260W | 11.92 30° | SHOWN |
| ✳ | MIR000N | MARK | 33°04.320N | 118°29.580W | 35.98 95° | SHOWN |
| ✳ | MIR002 | MARK | 33°41.230N | 118°58.941W | 43.65 288° | SHOWN |
| ✳ | MIR004 | MARK | 33°21.879N | 118°10.580W | 7.792 180° | SHOWN |
| ✳ | MIR005 | MARK | 33°25.958N | 118°12.351W | 2.165 180° | SHOWN |
| ✳ | DEST | MARK | 33°28.819N | 118°19.179W | 5.713 200° | SHOWN |

This page also allows you to:

- ICON** Allows sorting by icon type. Selections are:
SELECT: only User Points with the selected icon are shown
ALL: all User Points are shown
- FIND** Searches through the Marks or Waypoints to find a point by name. The touchscreen keyboard appears to insert the desired name.
- LOCATE** Shows (locates) the position of a Mark or Waypoint on the Chart page
- EDIT** Allows you to edit a previous stored Mark or Waypoint
- SORT** Allows sorting the name of User Points. Selections are:
A-Z ASCENDING: sorts the name of the Mark or Waypoint in ascending order
Z-A DESCENDING: sorts the name of the Mark or Waypoint in descending order

- NEW MARK** Creates a new Mark under the cursor position.

 - MODE** Controls how Marks or Waypoints are shown on the Chart page. Selections are:
 - SHOW:** icon and name are shown
 - ICON:** only icon (no name) is shown
 - HIDE:** Mark or Waypoint is hidden
 - SHOW ALL:** all Marks or Waypoints are shown
 - ICON ALL:** all icons are shown without name
 - HIDE ALL:** all Marks or Waypoints are hidden

 - DELETE** Allows deleting the selected point. Tap on **YES** to confirm.

 - DELETE ALL** Allows deleting all stored points. Tap on **YES** to confirm.

 - SEND** Sends the stored points to an external device (PC) capable of listening to NMEA-0183 WPL and RTE sentences. An information window appears after sending completed. Tap on **OK** to confirm.

 - RECEIVE** When selected, receives points from an external device (PC) that is capable of sending NMEA-0183 WPL sentence. An information window appears after receiving completed. Tap on **OK** to confirm.

-  The SEND and RECEIVE functions are usually used by navigation programs running on a PC.

2.6.6 CREATING/MODIFYING A MARK IN THE USER POINTS LIST

 This function is very useful if you have a list of Marks that you want to enter into the CPN Series Chart Plotter.

1. Press the **MENU** key, tap on **User Points**.
2. Tap on **MARKS**. The Marks/Waypoints List page will be shown.
3. To create a New Mark, tap on **NEW MARK**. A row is added (see A).
4. Tap on **EDIT**. The Mark Icon appears selected (see B).

NEW ROW

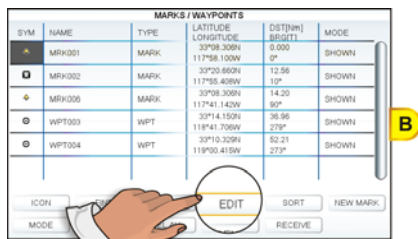
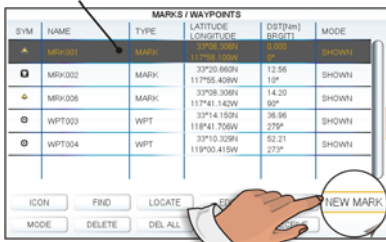

5. Press the **rotary knob**. The Mark Icons popup window appears.
6. Tap on the desired Mark Icon (see C). The Mark Icons window disappears.
7. Turn the **rotary knob** to the right to select the Mark Name field and press the **Rotary Knob**. The touchscreen keyboard appears. Insert the desired name (see D); when finished tap on **↩**, the keyboard disappears.

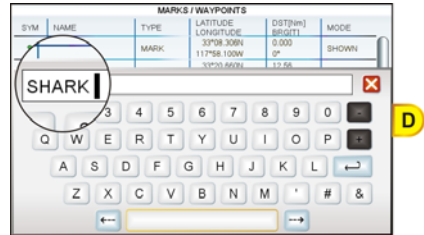
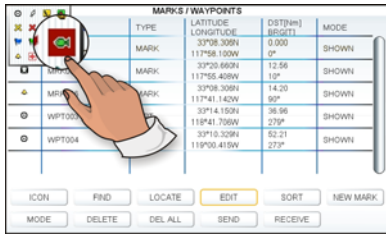

- Turn the rotary knob to the right to select the Latitude/Longitude field and press the rotary knob. Again the touchscreen keyboard appears. Insert the desired coordinates; when finished tap on ↵, the keyboard disappears.
- Turn the rotary knob to the right to select the Mod field and press the rotary knob.

! It is possible to use the ShuttlePoint knob in place of the rotary knob. Make sure that the ShuttlePoint Enter item (see Par. 2.1.4 "Settings in General Setup Menu") is set to On, so pressing the ShuttlePoint knob in the center is equal to confirm action.

- You can choose among **SHOW** to show on the chart the name and icon of Mark, **ICON** to show on the chart only the icon of Mark or **HIDE** to hide on the Chart page the created Mark. Tap on the desired modeto show the Mark.
- Press the CLEAR key to save the created Mark.
- Press the CLEAR key again and the new Mark appears on the Chart page (see E).

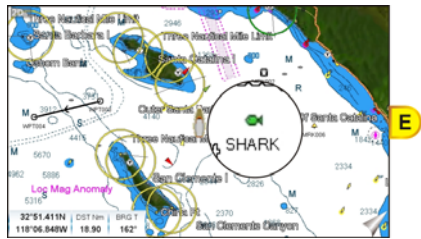

! After entering in a Mark it is a good practice to backup the points to a SD CARD.

2.7 ROUTES

A Route can consist of Waypoints or Marks. The difference is when a Route is made using Waypoints and the Route is deleted the Waypoints are also deleted. However if a Route is made of Marks and the Route is deleted the Marks stay in memory. See the example below that shows how the CPN Series Chart Plotter switches from one Waypoint to another.

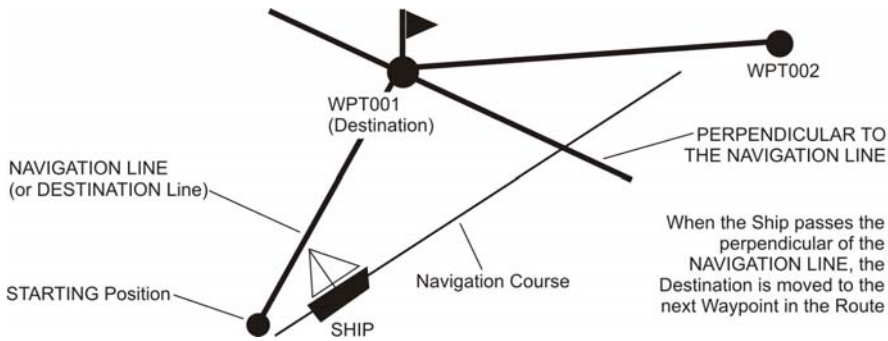

2.7.1 CREATING A ROUTE USING WAYPOINTS

1. On the Chart page move the ● ShuttlePoint knob or touch the screen to the Lat/Lon of the starting Waypoint in the Route.
2. Press the **ROUTE** key, you will notice the starting Waypoint will be placed under the cursor.
3. Move the ● ShuttlePoint knob or touch the screen to the second Lat/Lon of the next leg .
4. Press the **ROUTE** key. You will notice another Waypoint is shown under the cursor and a line joins the starting Waypoint to the second Waypoint.
5. Repeat steps 3 and 4 until all Waypoints are entered into the Route.



- At this point the Route is saved as ROUTE01. If you would like to save the Route under a specific name follow the next steps.

2.7.2 CHANGING THE NAME OF A ROUTE

1. To name the Route move the ● ShuttlePoint knob or touch the screen on the Route (on a Waypoint or on a leg). For example if you touch a Waypoint this screen appears:



- Tap on the **EDIT RTE** Soft Key. The Edit Route page appears:



| EDIT ROUTE | | | | | | | |
|------------|------------|-------------|-------|----------|---------|--------|------|
| ROUTE 1 | NAME | ROUTE1 | SPEED | 10.0 kts | FUEL | 10.0 h | |
| WAYPOINT | LATITUDE | LONGITUDE | BRG T | LDST nm | TDST nm | TIME | FUEL |
| WPT002 | 33°08.431N | 117°34.462W | | | | | |
| WPT003 | 33°12.238N | 117°28.889W | 45° | 5.437 | 5.407 | 000:32 | 5.43 |
| WPT004 | 33°07.241N | 117°23.800W | 135° | 7.077 | 12.48 | 001:14 | 12.4 |
| WPT005 | 33°07.241N | 117°14.351W | 90° | 7.999 | 20.48 | 002:02 | 20.4 |
| WPT006 | 33°12.238N | 117°09.250W | 45° | 7.235 | 27.72 | 002:46 | 27.7 |

SELECT **NAME** COLOR INVERT CLEAR SPEED FUEL

- Tap on **NAME**. The touchscreen keyboard appears. Insert the desired Route name; when finished tap on , the keyboard disappears.
- Press the **CLEAR** key to show the Chart page.

2.7.3 CREATING AN OLYMPIC ROUTE OR BOUNDARY

This feature allows the starting point in a Route to be saved as the final destination point.

- On the Chart page move the  or touch the screen to the Lat/Lon of the starting Waypoint in the Route.
- Press the **ROUTE** key, the starting Waypoint will be placed under the cursor.
- Move the  or touch the screen to the second Lat/Lon of the next leg in the Route.
- Press the **ROUTE** key. Another Waypoint is shown under the cursor and a line joins the starting Waypoint to the second Waypoint.
- Repeat steps 3 and 4 until all Waypoints are entered into the Route (see A).



- Then move the  or touch the screen to the last Waypoint.
- Tap on the **OLYMPIC** Soft Key. A line joins the starting Waypoint and the last Waypoint (see B and C).



2.7.4 MAKING ADDITIONAL ROUTES

To create another Route the CPN Series Chart Plotter must be told that you want to create a second Route.

1. Move the **ShuttlePoint** knob or touch the screen over the top of one of the Waypoints in a Route and tap on the **EDIT RTE** Soft Key. The Edit Route page will be shown.
2. Tap on **SELECT**.
3. Tap on an open Route number (example, Route 2).



4. Press the **CLEAR** key.
5. To create the new Route, follow the steps in the previous Par. 2.7.1 "Creating a Route using Waypoints".

2.7.5 CREATING A ROUTE USING MARKS ON THE CHART PAGE

To create a Route containing Marks you first must create the Marks and show them on the Chart page.

1. Move the **ShuttlePoint** knob over the top of a Mark that you wish to be the starting point in the Route and press the **ROUTE** key.

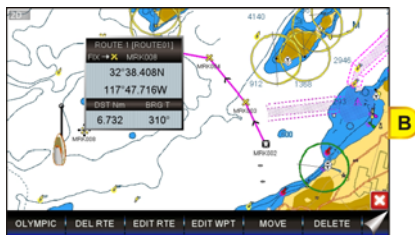



2. Next move the **ShuttlePoint** knob until the cursor is over the Mark that you want to be the next leg in the Route.
3. Press the **ROUTE** key. You will notice a bearing line joins the first and second Mark which means these Marks are selected into the Route.
4. Repeat steps 3 and 4 until all Marks are entered into the Route.

! You can touch the Mark on the display instead of using the **ShuttlePoint** knob.

2.7.6 INSERTING A WAYPOINT INTO A ROUTE

1. Touch or move the  ShuttlePoint knob to the navigation line between two Waypoints and tap on the **INSERT** Soft Key (see A).



2. The line between the two Waypoints is turned into a dotted line.
3. Move the  ShuttlePoint knob or touch the display in the desired location for the new Waypoint: the line will “rubber-band”, drawing a dotted line between the previous Waypoint and the cursor, and another dotted line between the cursor and the next Waypoint (see B). Once you have positioned the cursor at the location you want, tap on it or press the  rotary knob or the  ShuttlePoint knob (if enabled) (see C).

 When in 3D mode, the 2D mode is automatically triggered. When a Waypoint is placed, the CPN Series Chart Plotter remains in 2D mode.

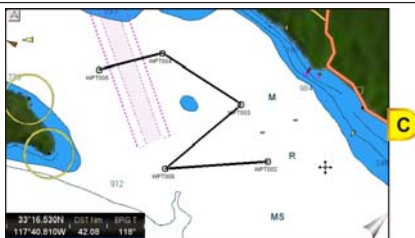

2.7.7 DELETING A ROUTE

To delete a Route follow the procedure below:

1. Press the **MENU** key, tap on **User Points**.
2. Tap on **ROUTE**.
3. Tap on **DELETE**.

 You can touch the Route and then press the **DEL RTE** Soft Key instead of step 1, 2 an 3.

4. A Warning message appears to confirm. Tap on **YES**. The Route will be deleted.

 An active Route (one that you are navigating to) cannot be deleted until you stop navigating to the Route.

2.7.8 OTHER SETTINGS IN ROUTE MENU

You will notice the **ROUTE** menu has other selections.

SELECT Chooses an available Route to create or a stored Route to show and follow on the Chart page.

| | |
|-------------------|--|
| REVERSE | Reverses the Route. When chosen, the starting point is at the end of the Route. |
| COLOR | Changes the color of the navigation lines between each leg in the Route. |
| EDIT ROUTE | Shows details of the Waypoints contained within the Route (Edit Route page). This menu also allows you to enter in your average speed and fuel consumption and calculate the approximate fuel used when following the Route. |
| SEND | Sends the stored points to an external device (PC) capable of listening to NMEA-0183 RTE sentences. |
| RECEIVE | Receives the points from an external device (PC) capable of sending NMEA-0183 RTE sentences. |
| THICKNESS | Allows the Route line to be easily seen; default selection is Thin. |

2.7.9 ROUTE CHECK

The Route Check function is used after you have created a Route to ensure you and your vessel will not encounter problems while navigating. This is done by the CPN Series Chart Plotter by reviewing the Route and looking for the following hazards that may affect safe navigation.

- Land Areas
- Shallow Water
- Intertidal Areas (*areas emerged at low tide*)
- Rocks
- Wrecks
- Obstructions
- Shoreline Constructions
- Fishing Facility
- Dredged Areas
- Diffusers (*submarine pipeline*)
- Mooring/Warping Facility
- Production Installation (*an installation for the exploitation of natural resources*)
- Pingos (*small conical hills having a large central core of ice formed from the encroachment of permafrost and the resulting hydrostatic pressure*)
- No Data Available (*no adequate data coverage*)

⚠ This function checks the objects that belong to the standard charts. It does not check the objects belong to the VAD categories.

If any of these alarm conditions is detected, the function returns a list of dangerous objects (see B) and the relative dangerous Route leg (drawn with a different color - see A).

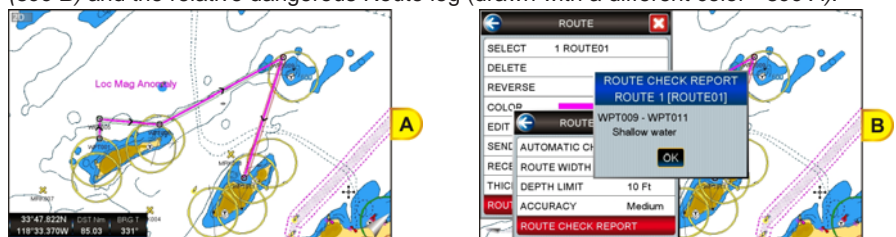

- Route legs which were classified as dangerous are displayed in RED. It means that there is at least one dangerous object in the vicinity of this leg and it has been found.
- Route legs which were classified as safe are displayed in GREEN. It means that the data was checked on detailed chart levels and no problems were found for all segments of the leg.
- Route legs for which there was not sufficient data to be checked are displayed in YELLOW. It means that no problems were found but the data was not sufficient or not available at all to classify such a leg as safe.

To activate the Route Check function:

1. Press the **MENU** key, tap on **User Points**.
2. Tap on **ROUTE**. The Route menu appears.
3. Tap on **ROUTE CHECK**. The Route Check menu appears. See the following table.

| | |
|---------------------------|---|
| AUTOMATIC CHECK | Turns the Route Checking feature On or Off. Turn the Automatic Route Check On after you have created a new Route (or if you inserted a new Waypoint, deleted, moved or edited any Waypoint in a saved Route) to confirm the Route can be safely navigated. |
| ROUTE WIDTH | Allows you to select the width from the left and right of the Route leg where the CPN Series Chart Plotter will check to confirm navigation threats. See the following picture. The default setting is 0.04Nm. |
| DEPTH LIMIT | Allows you to select the water depth in the Route width area so the CPN Series Chart Plotter can check and confirm underwater threats. It checks if some objects with the depth attribute (like Shallow Water, Dredged Areas, Diffusers, Obstructions, Pingos, Production Installation and Wrecks) are above this depth level. Only if the depth attribute is above the depth limit are they found and considered as dangerous. See the following picture. The default setting is 10ft. |
| ACCURACY | Defines a segment length into which a leg of the Route is divided in order to execute the search for dangerous objects with better accuracy. When accuracy is maximal, a segment length is the shortest. When accuracy is minimal, a segment length is the longest. Select among Minimum, Low, Medium, High and Maximum. See the following picture. The default setting is Medium. |
| ROUTE CHECK REPORT | Shows the list of the dangerous objects found on the charts crossed by the Route. |

⚠ Although the functionality is called Route Check, it can also be activated when the navigation is set to a single point (like DSC, MOB, Mark). In the case of checking a single point towards which the navigation is started, the leg for which the Route Check is executed is defined by the current position (the leg's starting point) and the destination point (the leg's ending point).

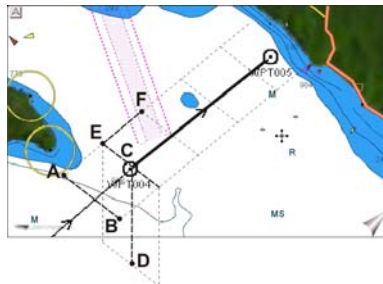

A-B = Width
C-D = Depth
E-F = Accuracy

2.7.10 EASY ROUTING (ER)

⚠ AVAILABLE WITH OPTIONAL C-MAP BY JEPPESEN CARTOGRAPHY ONLY.

Easy Routing calculates the shortest safe Route between two chosen points. Please note that the calculation of complex Routes can be time consuming.

With Easy Routing given a Start Point and End Point the CPN Series Chart Plotter will automatically propose the shortest safe Route connecting the two points. The calculation of the Route depends on a few parameters which define your boat and the precautions you want to keep for navigating. The parameters are boat length and width, keel depth, mast height, and a safe distance indicator. While calculating the Route the Easy Routing will avoid obstacles (such as Nav-Aids, Rocks, Obstructions, Shallow Waters, Bridges) and draw the final and proposed Route with different colors highlighting the possible hazards:

- RED color usually indicates a condition of unsafe navigation: for example a Route is crossing a very shallow water.

- **YELLOW** color shows legs where maximum attention should be taken: for example a bridge is present along the leg but its vertical clearance is not known from data.
- In case of **GREEN** color the leg is considered safe: there are no known hazards along the leg considering the parameters used.
- In certain cases, due to the complexity of the environment at, or surrounding, the Start/End point, Easy Routing will shift the point and place it in a safer location. This leg is indicated with **GRAY** color.

Please note that, due to the input data, it might not be possible for Easy Routing to avoid crossing hazard areas to reach the final destination (and, in this case, producing **RED** or **YELLOW** legs). In this case the Captain should review the proposed Route and, if required, modify it accordingly.

W The accuracy of Easy Routing is limited by the availability of electronic charts loaded on your navigation system and the accuracy of original source material used in producing such charts. Always remember that you should navigate with the most detailed and up-to-date chart data available from Jeppesen, and that new information from National Hydrographic Offices may render your charts obsolete at any time. Easy Routing will now calculate and save the best suggested Route between your Start and End points based on parameters set by you. Area between Start and End points is contained into a 100Nm side square, see image below:

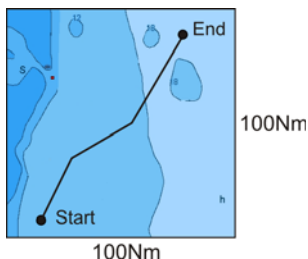

Easy Routing is only an aid to navigation and must be used in conjunction with conventional navigation practices.

W As the navigator of your vessel, you are responsible for reviewing the suggested Route against the official publications and situational awareness. You must edit and/or approve the suggested Route before using it for navigation purposes.

To activate this function:

1. Press the **MENU** key, tap on **User Points**.
2. Tap on **ER**. The Easy Routing menu window appears on the screen:



It allows setting of the parameters for the function. See the table below.

| | |
|--------------------|--|
| SAFE DEPTH | Takes in consideration boat's draught while making a Route. The default setting is 6.56ft (2m). |
| SAFE HEIGHT | Takes in consideration boat's height while making a Route. The default setting is 39.36ft (12m). |

| | |
|------------------------|--|
| SAFE CORRIDOR | Takes in consideration boat's width while making a Route. The default setting is 0.002Nm (4ft). |
| SAFE MARGIN | This is an On/Off setting which enables to calculate a Route at a distance greater than 300m from the coast. The default setting is On. |
| RESPECT DRAUGHT | When On, discards areas with a depth lower than the Safe Depth. The default setting is Off. |
| TIMEOUT | Sets the timeout after which the function exits automatically (if Route calculation is not yet completed). The default setting is 5 Minutes. |

- When all parameters are set, tap on **START EASY ROUTING**. A Warning window appears (see A). Move the ● ShuttlePoint knob up/down or turn the ● rotary knob to left/right or touch the scroll bar up/down to go from one page to another.
- Tap on **OK** to start the Easy Routing steps for defining the Start (start point for the path) and End (destination point for the path) points (otherwise tap on **EXIT** to abort). The Select Route window appears, to select the Route in which the calculated ER Route will be saved (see B).

! Start and End points can be defined not only under the current cursor position but also on a chosen User Point or geographical position or Port Service/POI.

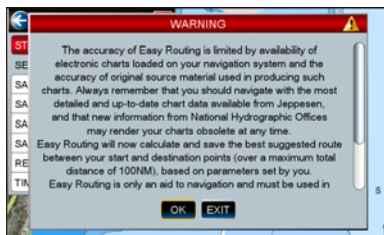

A

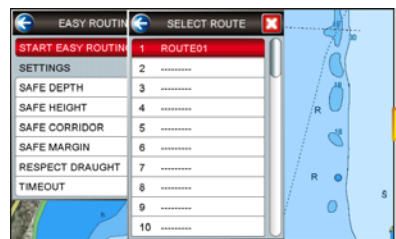

B

- Select the desired row by turning the ● rotary knob to left/right or touching the scroll bar up/down and tap on it (otherwise tap on **X** to close the window and abort the Easy Routing function). The Chart page appears.
- Anywhere on the Chart page move the ● ShuttlePoint knob or tap on the display to select the starting point, (see C) and then tap on the **ER START** Soft Key, to define the Start point. A new window appears (see D).

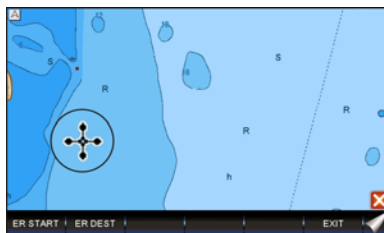

C



D

- Tap on **CURSOR**. The Start point is set on the cursor position (see E).
- Then move the ● ShuttlePoint knob or tap on the display to select the destination point and then tap on the **ER DEST** Soft Key, to define the End point. A new window appears.
- Tap on **CURSOR**. The End point is set on the cursor position (see F).

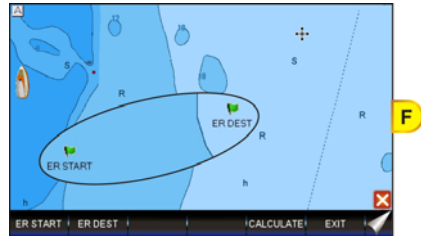

10. Tap on the **CALCULATE** Soft key, to start the Easy Routing calculation.
11. The message “Calculating the Route ...” appears. When calculation is completed, the report on the new Route appears (see G).
12. Tap on **DETAILS** to see more information. Otherwise tap on **OK**. The path between the two points appears on the screen (see H).

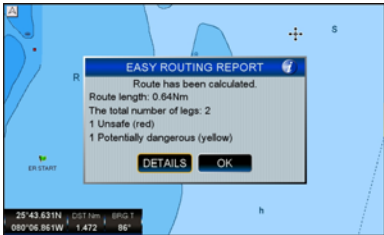

Warning Messages

The following warning messages might appear during Easy Routing operations.

- **Distance between Start and Destination points exceeded allowed limit of 100Nm. Calculation cannot be started.**
Displayed when the Start or End points are too distant.
- **Start and Destination points placed at the same position. Route has not been calculated.**
Displayed when the Start or End points have been set at the same position.
- **Timeout has been exceeded. Route has not been calculated.**
Displayed when the Route generation operation took more time than was allowed.
- **Latitude of the defined points is greater than 80°. Route has not been calculated.**
Displayed when the Start and/or End points Latitude is over 80° N/S.
- **Start or Destination point of Route cannot be moved to a navigable position on water. Route has not been calculated.**
Displayed when one or both the ends of the Route cannot be moved on water.
- **Route calculation has been halted.**
Displayed when the Route generation was aborted by a user.
- **Route has not been calculated.**
Displayed in all other error situations.
- **Route is too complex, calculation could not complete.**
Displayed when the Route to be calculated is too complex and there are memory problems to calculate it.
- **Destination present on a Route. Navigation will be stopped before Easy Routing begins.**
Displayed when the Destination is present on a Route.

- **Selected Route will be overwritten with results of Easy Routing. Do you want to proceed?**
Displayed to confirm an existing Route would be overwritten.
- **No charts with Easy Routing data found. Calculation cannot be started.**
Displayed when there is no Easy Routing data on the charts.
- **While calculating Easy Routing, the I/O activities of the Chart Plotter will slow down and might cause incorrect communication with the autopilot. It is strongly recommended that the autopilot is not engaged while Easy Routing calculation is being executed.**
Displayed when Easy Routing calculations is being activated.

Easy Routing touchscreen commands

- tap on **NEW** to define the Start and End points again
- tap on **CONTINUE** to start the Easy Route steps in which you can define the Start and End points
- tap on **EXIT** to exit from Easy Routing functionality

2.8 GOTO KEY OPERATION

The CPN Series Chart Plotter can easily be set to start navigating to the Cursor on the Chart page, a saved Mark or a Route.

2.8.1 GOTO CURSOR

1. Tap or move the **ShuttlePoint** knob to the exact position on the chart you want to navigate to.
2. Press the **GO TO** key and a GOTO popup window will be shown (see A).

! If an Easy Routing Route exists it will also be listed in the GOTO popup window (**ER** item).



3. Tap on **CURSOR**.
4. The CPN Series Chart Plotter now navigates from your current position to the location selected at step 1. A bearing line between the vessels location and the destination point is shown. A popup window shows the Distance (DST) and Bearing (BRG) from the vessel's location to the destination point (see B and C).



5. The CPN Series Chart Plotter is in Cursor Mode; to switch to Home Mode press the **CLEAR** key so the vessel will stay in the center of the page.

⚠ It will also automatically switch to Home Mode after the timeout set in Home Mode Revert.

6. Soft Keys are also shown that allow you to quickly switch to the Highway page or to stop navigation.

7. To stop navigation, press the **GOTO** key and a Warning window is shown. Tap on **STOP**.



2.8.2 GOTO A ROUTE

After you have created a few Routes, you can choose one of them to GOTO.

Using **GOTO** to select a Route

1. Tap on an open position (no buoy, warning etc. under the cursor) on the Chart page.
2. Press the **GOTO** key to show the GOTO popup window (see A).

⚠ If you place cursor over a cartographic object the GOTO popup window will be shown too. The only situation when GOTO will not show this popup window but will start navigation straight away is when the cursor is over a User Point. In such a case the navigation will be started directly to the selected User Point. The **GOTO** key will not work when a warning, alarm etc. window is displayed on the screen.





3. Tap on **ROUTE**.
4. The SELECT ROUTE window will be shown (see B).
5. Select the desired Route by moving the **ShuttlePoint** knob up/down or turning the **rotary knob** to left/right or touching the scroll bar up/down and tap on it.

⚠ If an empty row has been selected, a Warning window appears, tap on **OK**.

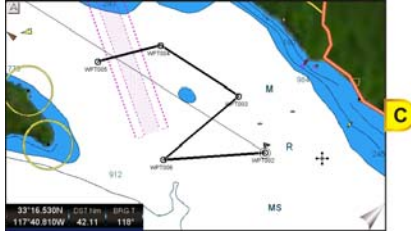



- On the Chart page, a circle with a flag is shown on the first leg of the Route you chose and a navigation line is shown, indicating the CPN Series Chart Plotter is navigating to the first Waypoint in the Route (see C).





Using the ShuttlePoint knob

- On the Chart page move the  ShuttlePoint knob until the cursor reaches the starting point (or any Waypoint in the Route) of the Route.
- Press the  key to start following the Route.
- Press the  key twice to revert to Home Mode.

2.8.3 GOTO MARK

- Move the  ShuttlePoint knob to an open position (no buoy, warning etc. under the cursor) on the Chart page.
- Press the  key to show the GOTO popup window.
- Tap on **MARK** to show the **MARKS/WAYPOINTS** List.
- Tap on the desired Mark or Waypoint and press the  key.
- You will notice a circle is drawn around the Icon Symbol. This means the CPN Series Chart Plotter is now navigating to the point.
- Press the  key to close the Marks/Waypoints List page.

 The CPN Series Chart Plotters can start navigating to the cursor location, a saved Mark or any Waypoint in a Route simply by touching the display or moving the cursor using the  ShuttlePoint knob to a location or on the top of a Mark or Waypoint on the chart and pressing the  key.

2.9 MAN OVER BOARD (MOB) FUNCTION

During navigation, the “MOB” feature provides a one-touch method of storing a location, such as a point where a crew member fell overboard. In this mode, the CPN Series Chart Plotter places a MOB point on the Chart page and all the navigation data shown is related to navigating back to this point, allowing you to retrace your path to the MOB point efficiently.

2.9.1 PLACING A MOB POINT

1. On the Chart page, press the **MOB** key to start navigation back to the point. A Warning window appears to advise that the MOB function has been activated, tap on **OK**.
2. Press the **CLEAR** key. You will notice a MOB Mark on the Chart page and all navigation is referring back to this point (see A).

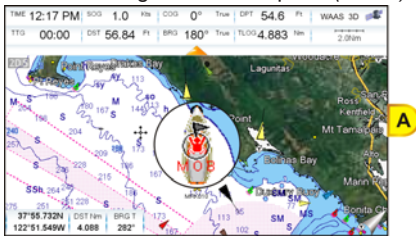

3. To stop navigation to the MOB point, press the **GOTO** key: the Soft Keys are displayed (see B), tap on **STOP**.

2.9.2 DELETING A MOB POINT

1. After stopping navigation to the MOB point, tap on the MOB icon. The Soft Keys appear (see A).



2. Tap on the **DELETE** Soft Key. A popup window will be shown to confirm deleting the MOB point (see B).
3. Tap on **YES**.

ⓘ Pressing the **MOB** key again allows deleting a previous MOB. A Warning window appears to advise that MOB is already present, tap on **DELETE**. This allows to stop navigation to the MOB point and also deleting it.

2.10 TRACKS

The CPN Series Chart Plotter has the capability to store 20 individual Tracks and record up to 10,000 Track Points.

ⓘ Please note the Track Points memory is 10,000 points. This means for a long journey you may have to adjust the tracking time or distance to be able to track your journey. It should be noted when the 10,000 Track Points are used up, the first Track point laid down will be deleted when a new point is placed on the chart.

Before using the Track function you will need to setup the Track function that suits your boat. The Track function records your vessel's location as it moves through the water. The Track function can be setup to lay down a Track for a predetermined time or distance interval. If you have a fast-moving boat you may want to setup the CPN Series Chart Plotter to record a Track point every 0.5Nm or if you have a sail boat you may want to setup to lay down a Track point once every 1 minute.

To set the time or distance interval you should follow the procedure:

1. Press the **MENU** key, tap on **User Points**.
2. Tap on **TRACK**. The Track menu appears.



3. Tapping on **STEP UNIT** selects between **Dist** or **Time**.
4. Tap on **DISTANCE** or **TIME** step interval.
5. Tap on the desired step value and tap on it.
6. Press the **CLEAR** key or tap on **X** in the Track window to exit the menu.

When using the Tracking feature you will notice every time a Track Point is laid down on the Chart page a small filled in circle is shown on the Track line.

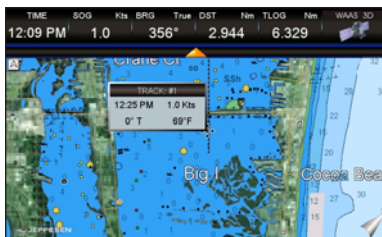



If you move the cursor over the top of the circle a popup window will be shown with the Time, Water Temperature, Speed and Course Over Ground (COG). This is very useful if you are fishing and want to review the conditions where the fish were being caught.





2.10.1 SAVING AND STARTING A NEW TRACK

A Track can be saved and retained in memory when the power is turned off. To start a new Track:

1. Press the **MENU** key, tap on **User Points**.
2. Tap on **TRACK**.

3. Tap on **ACTIVE TRACK**.
4. Enter the next Track number using the touchscreen keyboard. Tap on  to select the new Track.
5. Tap on **TRACKING** to start laying down Track Points.
6. Tap on  to exit the menu to the Chart page.

2.10.2 DELETING A TRACK

1. Press the  key, tap on **User Points**.
2. Tap on **TRACK**.
3. Tap on **ACTIVE TRACK**.
4. Enter the Track number using the touchscreen keyboard. Tap on .
4. Tap on **DELETE**.
5. A warning window will be shown to confirm if you want to reset the Track. Tap on . The Track is now deleted.
6. Tap on  to exit the menu to the Chart page.

2.10.3 OTHER SETTINGS IN THE TRACK MENU

You will notice the Track Menu has other selections:

| | |
|---------------------|---|
| TRACKING | Allows turning On or Off (default) the Tracking function. |
| ACTIVE TRACK | Allows saving a Track to one of the 5 Tracks available. Track 1 is the default. |
| VISIBLE | Shows (On) or hides (default, Off) a Track selected in ACTIVE TRACK menu. |
| LINE COLOR | Selects the color of the Track line. |
| DELETE | Deletes a Track selected in the ACTIVE TRACK menu. |
| STEP UNIT | Allowable selections are Distance (default) or Time . |
| DISTANCE | User adjustable Distance interval of when Track point is laid down on the Chart page. 0.1Nm is the default setting. |
| TIME | User adjustable Time interval of when Track point is laid down on the Chart page. 5 min is the default setting. |

2.11 TRIP LOG

2.11.1 TRIP LOG SELECTION IN DATA WINDOW

On the Chart, Navigation, Highway and NMEA Data pages the windows may be customized to show Trip Log information.

1. Select one of the pages listed above, press and hold the  key. You will notice one of the data boxes will be highlighted in yellow.
2. Tap on the yellow highlighted window to show the menu popup window.
3. Tap on **NAVIGATION**.
4. Tap on **Trip Log (TLOG)**.



5. Press the **CLEAR** key one time so yellow highlight is removed from the data window.

2.11.2 RESETTING THE TRIP LOG

When Trip Log is selected in one of the data windows and you want to reset the Log:

1. Press and hold the **MENU** key until a field is highlighted (it will be shown in a yellow frame).
2. Tap on **TLOG**.
3. A menu popup window will be shown. Tap on **RESET**.
4. A Warning window will be shown to confirm if you want to reset the Trip Log. Tap on **YES**. The Trip Log is now reset.



6. Press the **CLEAR** key two times to store and exit the editing mode.

2.12 USER SD CARD

An optional User SD CARD can be used to backup Marks, Routes, and Tracks stored in your CPN Series Chart Plotter's memory.

! Any SD CARD can become a User SD CARD, as long as the SD CARD is initialized (see the following Par. 2.12.1 "Initializing the SD CARD").

The User SD CARD is similar to a backup disk used with a PC. The User SD CARD is useful to backup User Points when the RAM has to be cleared to resolve an issue or load new Software, or if you would like to transfer Waypoint, Track and Route information from one STANDARD HORIZON CPN Series Chart Plotter to another.

To select the User SD CARD menu follow the procedure:

1. Open the SD CARD door and insert a User SD CARD.
2. Press the **MENU** key, tap on **User Points**.
3. Tap on the right arrow next to DSC DIR Desktop icon two times to display USER CARD.
4. Tap on **USER CARD**. The User SD CARD page appears.

! If a not initialized SD CARD is present in the slot, a Warning window is shown.

- 1 Time of file creation
- 2 Date of file creation
- 3 Type of data contained in the file (Mark file, Waypoint file...)
- 4 File name
- 5 Number of Selected file
- 6 Information on stored User Points on Internal Memory



2.12.1 INITIALIZING THE SD CARD

The initialization or formatting of a SD CARD prepares the SD CARD to receive and store information. Initialization permanently erases user data previously saved on the SD CARD, but it does not affect the cartographic data present on the SD CARD.

1. Open the SD CARD door and insert the SD CARD.

! If there is another SD CARD inserted into the slot yet, before following the initializing procedure, please safely remove it using the following steps:

1. Press the **MENU** key, tap on **Setup Menu**.
2. Tap on the right arrow next to ADVANCED Desktop icon two times to display **ABOUT** and tap on it.
3. Tap anywhere in the About page to display Soft Keys.
4. Tap on the **REMOVE SD** Soft Key. A message is shown informing you that it is possible to remove the cartridge from the slot.
5. Tap on **CONFIRM** in the popup window, then on **CLOSE** in the next window.
6. Open the door and gently remove the SD CARD from the slot.
7. Press the **CLEAR** key repeatedly to exit.

2. Press the **MENU** key, tap on **User Points**.
3. Tap on the right arrow next to DSC DIR Desktop icon two times to display USER CARD.
4. Tap on **USER CARD**. The USER SD CARD page appears.
5. Tap on the **FORMAT** Soft Key.
6. A Warning window appears to confirm you want to format the SD CARD.
7. Tap on **YES** to confirm (or press the **CLEAR** key).
8. Tap on **OK** to confirm.

2.12.2 TRANSFERRING FILES TO A USER SD CARD

1. Insert a User SD CARD into the slot.
2. Press the **MENU** key, tap on **User Points**.

3. Tap on the right arrow next to DSC DIR Desktop icon two times to display USER CARD.
4. Tap on **USER CARD**. The User SD CARD page appears.
5. Tap on the **SAVE** Soft Key.
6. A popup **SAVE FILE** window appears. In this window you can change the name and the file type tapping on it.
7. To save the file, tap on **SAVE** in window. The Information window momentarily shows **SAVING**, then shows **SAVING...OK**.
8. Tap on **OK** to confirm.

2.12.3 LOADING A FILE FROM A USER SD CARD

If you have a problem and accidentally lose the User Points in the CPN Series Chart Plotter, with a User SD CARD it is possible to load the data back into the CPN Series Chart Plotter. Using the following procedure to load a file from the User SD CARD inserted in the slot:

1. Press the **MENU** key, tap on **User Points**.
2. Tap on the right arrow next to DSC DIR Desktop icon two times to display USER CARD.
3. Tap on **USER CARD**. The User SD CARD page appears.
4. Select the saved file from the User SD CARD list by tapping on it.
5. Tap on the **LOAD** Soft Key. The Information window **LOADING...OK** appears when loading is complete.
6. Tap on **OK** to confirm.

2.12.4 DELETING A FILE FROM A USER SD CARD

You may want to delete a saved file on the User SD CARD inserted in the slot.

1. Press the **MENU** key, tap on **User Points**.
2. Tap on the right arrow next to DSC DIR Desktop icon two times to display USER CARD.
3. Tap on **USER CARD**. The User SD CARD page appears.
4. Select the saved file from the User SD CARD list by tapping on it.
5. Tap on the **DELETE** Soft Key. The Warning window appears to confirm you want to delete the file.
6. Tap on **YES** to confirm.

2.12.5 REFRESHING A USER SD CARD

If you opened the User SD CARD page, you may want to change the User SD CARD inserted in the slot with a new one.

 If a cartographic SD CARD is inserted into the slot, do not follow the procedure below. Please refer to Par. 2.3 "Removing the SD CARD".

1. Open the door, remove the existing User SD CARD from the slot and insert another User SD CARD into the same slot.
2. Tap on the **REFRESH** Soft Key. This "new" User SD CARD is now ready to receive and store information.

2.13 MAIN MENU

The Main Menu allows quick and easy Page Selection and setup of the CPN Series Chart Plotter. Press the **MENU** key from any page to show the Main Menu. This display consists of two parts:

- ① Page Icons
- ① Desktop Icons



- the page selection area with the **Page Icons** ①. There are 10 Page Icons specified: Chart, Navigation, NMEA, Fish Finder (only active when FF connected), Tide, User Points, Alarms, Video Input (only active when Video Camera connected), Setup Menu and AIS.
- the desktop area with the **Desktop Icons** ②. Each Page Icon has a defined related set of Desktop Icons.

Only 8 Page Icons can be displayed on the screen at one time. To scroll to the next column of Page Icons, the right hand arrow (or top right hand arrow if two are displayed) can be tapped. It will be active as long as there are more Page Icons to be displayed. In order to display the previous set of Page Icons the top left arrow has to be tapped. It is active until the initial set of icons is displayed.



The same scrolling mechanism is applied to the Desktop area.

The selected Page Icon and Desktop Icon are graphically marked for easy identification.



-
- ⓘ Refer to the previous image you will notice right arrows which when pressed will show additional Page Icons or Desktop Icons depending on the arrow pressed. To display a previous set of Page or Desktop Icons tap on the left arrow.
-

2.13.1 SELECTING A PAGE OR MENU

1. Press the **MENU** key to show the Main Menu.
2. Tap on the desired Page Icon. The related set of Desktop Icons is displayed in the Desktop area on the bottom of the page.

-
- ⓘ  ShuttlePoint knob
Page icons may be selected by moving the  ShuttlePoint knob up/down or left/right.
-

3. Tap on the desired Desktop Icon to change the display.

-
- ⓘ  Rotary knob
Desktop Icons may be chosen and selected by rotating the  rotary knob and pressing it in.
-

For example, to select the Dual Chart page:

1. Press the **MENU** key.
2. Tap on **Chart** page Icon. In the bottom of the page the available Desktop Icons appear (see A).
3. Tap on **DUAL** Desktop Icon (see B). The Dual Chart page appears (see C).



2.13.2 CUSTOMIZING A PAGE ICON

1. Tap on the icon to be changed.
2. Press and hold the **MENU** key to show the Page Icons Selection menu.
3. Tap on a page name to switch the location of the two icons.



2.13.3 CHART PAGE

The Chart page is the main page of the CPN Series Chart Plotter. From this page you can zoom in/out, pan around the chart, show information about cartographic objects, see the exact vessel position with the COG and SOG, place points, GOTO a destination point, show Track history etc.

1. Press the **MENU** key, tap on **Chart**. In the bottom of the page the available icons appear: **SINGLE** opens the Chart page, **DUAL** opens the Dual Chart page, **& HIGHWAY** opens the Chart/Highway page, **FIND** opens the Find Services & More menu and **C-WEATHER** opens the C-Weather page.



ⓘ For **& HIGHWAY** please see “Chart/Highway” in Par. 2.13.4 “Navigation Pages”, for **FIND** see Par. 2.4 “Using Find Services” and for **C-WEATHER** see Par. 2.16 “C-MAP Weather Forecast Service”.

Single

To show a Single Chart, follow the procedure below:

1. Press the **MENU** key, tap on **Chart**.
2. Tap on **SINGLE**.



1 Time
2 Speed Over Ground
3 Course Over Ground
4 Depth
5 Fix status
6 Time To Go (If plotter is not navigating to a point TTG will show --:--)
7 Distance from Fix to Destination (If plotter is not navigating to a point DST will show ---)
8 Bearing from Fix to Destination (If plotter is not navigating to a point BRG will show ---°)
9 Cursor Coordinates
10 Distance/Bearings from Fix to Cursor
11 Chart Scale
12 Trip Log

Dual

Selecting this page will show two chart windows. Each window's chart settings are independent of the other.

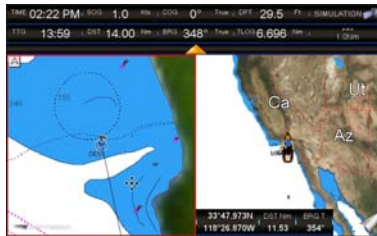

1. Press the **MENU** key, tap on **Chart**.
2. Tap on **DUAL**.



When Dual Chart is selected, you will notice one of the chart windows will have a red border around it. This red border indicates which chart window the CPN Series Chart Plotter has the focus on, meaning if the ShuttlePoint knob is moved the cursor on chart window will move. The focus may be changed to the other chart window by tapping on the desired screen: the red border around the window is moved from active window to the other.

Data Window Selections

The CPN Series Chart Plotter windows, displayed on Chart, Dual Chart and C-Weather pages, may be changed in the following way.

1. To change, press the  key, tap on **Setup Menu**.
2. Tap on **GENERAL**.
3. Tap on **CHART PAGE WINDOW**.
4. Tap on the desired selection. The default is the 2 lines small window.
5. Tap on  to exit to the Chart page.

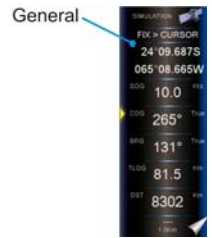
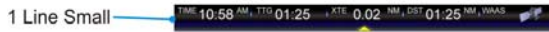
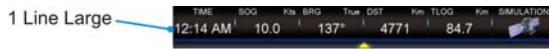

Customizing Data Windows

The data fields contained on the General, 1 line small/large and 2 lines small data windows can be changed to the following selections:

- Chart Scale¹

GPS selections

- POS = Position²
- SOG = Speed Over Ground
- COG = Course Over Ground
- HDG = Heading from Electronic Compass
- ALT = Altitude
- HDOP = Horizontal Dilution of Precision
- VDOP = Vertical Dilution of Precision
- DATE = Current Date
- TIME = Current Time

NAVIGATION selections

- DST = Distance to navigated point³
- BRG = Bearing to navigated point³
- XTE = Cross Track Error
- TTT = Time To Go
- STR = Steering Angle
- TLOG = Trip Log
- VMG = Velocity Made Good
- ETA = Estimated Time of Arrival
- TRK = Available free Track point
- VEL = Max Speed Log

ENVIRONMENT selections

- DPT = Depth
- SPD = Speed Through Water
- AWS = Apparent Wind Speed
- AWD = Apparent Wind Direction
- TWS = True Wind Speed
- TWD = True Wind Direction
- W-T = Water Temperature
- A-T = Air Temperature

- A-P = Atmospheric Pressure
- DEW = Dew point Temperature

1 Chart Scale is available only for Chart pages (1 line small, 2 lines small, 1 line large) and is always displayed in the General Chart window (it is not customizable there).

2 Available only on the Highway page/Chart page 1 line large.

3 When the GENERAL window is selected and the CPN Series Chart Plotter is in Home Mode, the BRG will show --, unless the CPN Series Chart Plotter is navigating to a point. When in Cursor Mode, the BRG shows the Bearing from the ship's position to the cursor location.

To select the desired field, follow the procedure:

1. Press and hold the **MENU** key until a field is highlighted (it will be shown in a yellow frame, see A).
2. Tap on the desired data field (the yellow frame is moved to the desired data field). The menu popup window will be shown (see B).



3. Tap on the desired data (**Chart Scale**) or group as **GPS**, **NAVIGATION** or **ENVIRONMENT**. In this case another popup window will be shown (see C).
4. Tap on the desired setting. Both popup windows will be closed, and the selection you made will appear in the desired box. (see D).

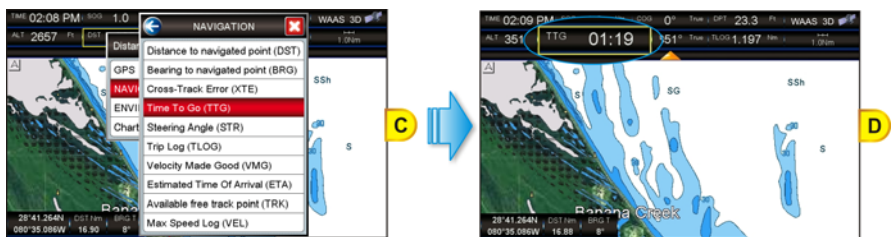

For Data Boxes which can be displayed in different units, units can be selected in General Setup menu (see Par. 2.1.4 "Settings in General Setup Menu").





5. Press the **CLEAR** key to store and exit the editing mode.

Data window field on the Compass, Highway, GPS Status, Digital and Analog Display and Fish Finder pages and gauges on Analog Display may be customized in the above manner.

Collapsing Data Windows

A data window may be visible or collapsed, to show less or more chart area. To collapse or expand a window, tap on the arrow key as show on the following image.



- If the Data Window is enlarged, touching the icon  collapses the 1 line large / 1 line small / 2 lines small Data Window and touching the icon  collapses the General Data Window.
- If the Data Window is collapsed, touching  expands the Data Window back to 1 line large / 1 line small / 2 lines small or touching  expands the General.

Additional Functions on Chart page: Information on Objects

When on the Chart page you will notice icons of Buoys, Towers, Lights, Wrecks, Tide Stations, Port Icons, and so on. If the cursor is moved over the top of these icons a popup window will be shown containing information about the icon (this is possible only if the Auto Info function is enabled).

The CPN Series Chart Plotter allows you to see information **On All** cartographic objects shown on the screen (see A), or only **On Points** (see B) or to turn this function Off (in this case no popup window is shown when the cursor is placed on a cartographic object - see C). The default setting is On Points.





To select the information displayed on Objects follow the procedure:

1. Press the **MENU** key, tap on **Setup Menu**.
2. Tap on **GENERAL**.
3. Turn the **rotary knob** to select **AUTO INFO** and tap on it.
4. Tap on **Off**, **On Points** or **On All**.
5. When the item you want has been selected, press the **CLEAR** key to exit the menu.

Display Mode

Selects from a pre-defined table what cartographic objects are displayed and which display options are set. Pre-programmed settings are user selectable from Full, Medium, Low, Radar (reduces the information on the display to simulate items that would be shown on a Radar display. Please note this function is not actually showing Radar information it is only showing what typically would be shown by a separate dedicated Radar display), Tides, Custom (default mode).

To change to one of the pre-programmed settings follow the steps described below:

1. Press the **MENU** key, tap on **Setup Menu**.
2. Tap on **CHART**. The Chart Configurations menu appears.
3. Tap on **DISPLAY MODE**.

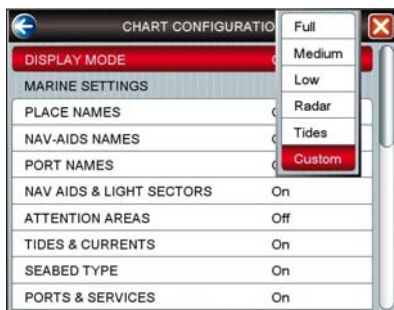

4. Tap on the desired preset among **Full**, **Medium**, **Low**, **Radar**, **Tides** and **Custom**.
5. Tap on **X** to exit to the Chart page.

The following table shows the selections for each mode:

| Setting | Full | Medium | Low | Radar | Tides | Custom (Default values) |
|--------------------------|--------------|------------|------------|------------|---------|----------------------------|
| Place Names | On | On | On | On | On | On |
| Nav-Aids Names | On | Off | Off | Off | Off | Off |
| Port Names | On | Off | Off | Off | Off | Off |
| Nav-Aids & Light Sectors | On | No Sectors | No Sectors | No Sectors | Off | On |
| Attention Areas | On | On | Off | Off | Off | On |
| Tides & Currents | On | Off | Off | Off | On | On |
| Seabed Type | On | Off | Off | Off | Off | On |
| Ports & Services | On | On | Off | On | Off | On |
| Tracks & Routes | On | Off | Off | Off | Off | On |
| Depth Shading Mode | Dynamic | Dynamic | Dynamic | Dynamic | Dynamic | Dynamic |
| Safe Depth | 15ft | 15ft | 15ft | 15ft | 15ft | 15ft |
| Depth Range Min | 0ft | 0ft | 0ft | 0ft | 0ft | 0ft |
| Depth Range Max | 32804ft | 32804ft | 32804ft | 32804ft | 32804ft | 32804ft |
| Lat/Lon Grid | On | Off | Off | Off | Off | Off |
| Boundaries Mode | Auto | Auto | Auto | Auto | Auto | Auto |
| Chart Boundaries | On | Off | Off | Off | Off | Off |
| VAD Boundaries | On | Off | Off | Off | On | Off |
| Chart Lock | On | On | On | On | On | On |
| Underwater Ob. Limit | 1000ft | 32ft | 32ft | 32ft | 32ft | 1000ft |
| Rocks | Icon + Depth | Icon | Icon | Icon | Icon | Icon |
| Obstructions | Icon + Depth | Icon | Icon | Icon | Icon | Icon |
| Diffusers | Icon + Depth | Icon | Icon | Icon | Icon | Icon |
| Wrecks | Icon + Depth | Icon | Icon | Icon | Icon | Icon |

Marine Settings

Controls the display on the chart of the marine features.

| | |
|--------------------------------------|---|
| Place Names | : Turns the local area names On or Off . |
| Nav-Aids Names | : Turns the Nav-Aids names On or Off . |
| Port Names | : Turns the Port names On or Off . |
| Nav-Aids & Light Sectors: | Turns the presentation of Lights, Signals, Buoys and Beacons On (Nav-Aids & Light Sectors are shown), Off (Nav-Aids & Light Sectors are not shown) or No Sectors (Nav-Aids are shown, Light Sectors are hidden). |
| Attention Areas | : Turns the Attention Areas (areas in which special attention by the mariner is required because of natural or man-made hazards sailing regulations and restrictions) On or Off . |
| Tides & Currents | : Turns the Tides and Currents On or Off . When data/time is available, Tidal stream arrows are shown on the charts, indicating the direction and strength of the Tide. If no data/time is available from the GPS or the CPN Series Chart Plotter is not in Simulation Mode, the icon on the chart is generic one. The color of the arrow denotes the strength of the current as follows: |
| | |
| | When the CPN Series Chart Plotter receives a valid position fix, the Tide icons are shown on the charts on the basis of the current date and time: the screen displays and changes arrows as date/time changes. |
| Seabed Type | : Turns the Seabed Type On or Off . |
| Ports & Services | : Turns the Ports and Service icons (areas along the shore with facilities for mooring, loading and unloading of ships, generally sheltered from waves and winds; Port installations are piers, wharves, pontoons, dry docks, cranes) On or Off . |
| Tracks & Routes | : Turns the Tracks and Routes objects (recommended and established Routes for ships at sea, including traffic separation schemes, deep water routes) On or Off . |

Depth Settings

Controls the depth information on the Chart page.

Depth Shading Mode : Selects among three different Depth Shading Modes: **Safe**, **Dynamic** and **Dynamic Inverted**. Each shading method presents the depth area, and the color used to display it, according to a different rule. In Dynamic and Dynamic Inverted modes, it is possible to highlight a particular depth area selecting a depth interval; you can choose a particular depth range and each depth area which overlaps these values will be highlighted with a defined color.

Dynamic: When shading mode is set to Dynamic, the depth areas are drawn using a color defined dynamically according to the depth of the other areas that have to be displayed. It is possible to summarize the behavior of this mode in these few steps: first of all, any depth will be collected in a ordered list, then 32 different blue colors from dark blue to white are assigned to these values. White is used to draw the highest depth area.

Dynamic Inverted: Dynamic Inverted mode is similar to Dynamic mode; the only difference is that dark blue will be used for the highest depth area and white for the lowest depth area.

Safe: Safe mode allows you to identify the areas with a depth above a value specified by you (see the Safe Depth option). This shading mode is very important to identify the map region where the depth is greater than a specified value and for this reason the shipping can be considered safe.

Safe Depth : In Safe mode, it is necessary to set the value for the Safe Depth to identify safe and unsafe area. If this value is not set, all depth areas appear with the same color. Sets the value in the range 0 - 1000ft.

Depth Range Min : Sets the minimum depth limit for Spot Soundings and Depth Contours.

Depth Range Max : Sets the maximum depth limit for Spot Soundings and Depth Contours.

0-1000 Ft



50-100 Ft

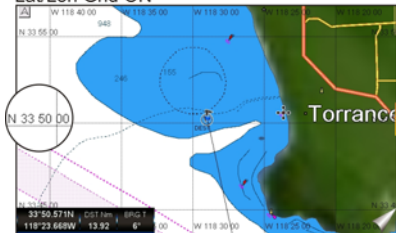

Chart Settings

Settings that control how the chart features will be shown on the Chart page of the CPN Series Chart Plotter.

Lat/Lon Grid : Turns the Latitude and Longitude grid lines **On** (see A) or **Off** (see B) on the Chart page.

Lat/Lon Grid ON



Lat/Lon Grid OFF



Boundaries Mode : Selects the Boundaries Mode **Auto** (only the boundaries of the four next levels are shown) or **Manual** (all boundaries are shown). Boundaries Mode applies both to the standard Chart Boundaries and to VAD Boundaries.

Chart Boundaries : Turns the Chart Boundaries **On** (see A) or **Off** (see B). The Chart Boundaries are the "ticked" boxes surrounding the coastline. Each box indicates an area where more detail is available. The Chart Boundaries are shown with a C-MAP 4D SD CARD or without (shows coverage area of Built-In Charts!).

! For North America users only.

! While the Boundaries Mode and Chart Boundaries settings are set to Manual and On, respectively, depending on the chart area being displayed and the current zoom level, some degradation in the performance of the CPN Series Chart Plotter may be experienced. If this occurs, it will also be visible as reduced response when using the menus: for example, when a menu item is selected the item might not respond for several seconds: The Boundaries Mode setting of Auto, with Chart Boundaries set to On, provides a combination believed to be adequate for the majority of situations where you want to display the Chart Boundaries.

Chart Boundaries ON



Chart Boundaries OFF



VAD Boundaries : Turns the Value Added Data Boundaries **On** or **Off**. The Value Added Data (VAD) is a collection of additional cartographic objects which are not present on the original paper chart. These objects have been obtained from other sources and then merged to the C-MAP 4D charts in order to provide more information useful for the navigation.



Chart Lock : Turns the chart function **On/Off**. When Chart Lock is On, the available zoom scales are only the ones containing cartographic data. Instead when Chart Lock is Off, it is possible to zoom down into zoom scales not covered by cartographic data. The Safety Status Bar DSI (Data Safety Indicator) window, if present, will show "NO CHART", when the CPN Series Chart Plotter is zoomed into a chart level which does not contain cartographic data.

Underwater Objects Settings

The following selections are used to control which Underwater Objects are shown on the Chart page.

Underwater Object Limit¹ : Selects the max depth value to display Underwater Objects. If value is set to 0ft, the Underwater Objects are not shown on the chart display. If the depth value is set more than 0ft (i.e. 10ft), depth information will be shown on the chart display from 0ft to the selected depth.

Rocks : Sets **Icon/Icon+Depth²** for displaying Rocks.

Obstructions : Sets **Icon/Icon+Depth²** for displaying Obstructions.

Diffusers : Sets **Icon/Icon+Depth²** for displaying Diffusers (a Diffuser is a structure usually found on top of a submerged pipe that helps diffuse material into the water, i.e. discharge or wastewater, and can be an obstruction to navigation).

Wrecks : Sets **Icon/Icon+Depth²** for displaying Wrecks.

! The Underwater Objects shown on the chart display could be up to 3ft deeper than the entered value to guarantee a safety tolerance margin.

- ① Selections: **ICON** (the object icon is visible, in the range selected from "Underwater Object Depth Limit" option); **ICON+DEPTH** (the object icon and the depth are visible, in the range selected from "Underwater Object Depth Limit" option).

2.13.4 NAVIGATION PAGES

Pages contained on the Navigation Desktop are useful for navigating to a Waypoint or viewing the status of GPS signals.

1. Press the **MENU** key, tap on **Navigation**. In the bottom of the page the available selections appear: **HIGHWAY** opens the Highway page, **COMPASS** opens the Compass page and **GPS** opens the GPS Status page.

Highway page

Shows a 3D Highway view of the vessel travelling through the water only when navigating to a destination point, Mark or following a Route.

1. Press the **MENU** key, tap on **Navigation**.
2. Tap on **HIGHWAY**. The Highway page appears. Data Boxes on the Highway page can be customized, except for GPS Status (see ⑧ in the following picture).

- ① Highway Display
- ② Highway Scale
- ③ Speed Over Ground
- ④ Course Over Ground
- ⑤ Bearing to Destination
- ⑥ Distance to Destination
- ⑦ Time To Go
- ⑧ WAAS/GPS Icon

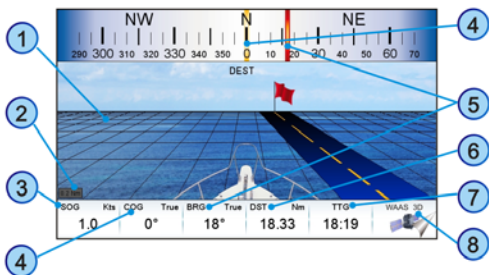

3. In the bottom left corner of the Highway page there is a small gray window (see ② in the following picture) which shows the Scale (width) of the Highway. The default width is 0.2Nm however this may be changed by tapping a finger anywhere on the display to show two Soft Keys. Tap on the **SCALE -** Soft Key or on the **SCALE +** Soft Key to change the scale of the Highway.

Chart/Highway page

It is possible to set the Chart page and the Highway page on the same screen:

1. Press the **MENU** key, tap on **Chart**.
2. Tap on **& HIGHWAY**.



Compass page

This page is useful to show information when heading to a destination, following a compass heading or navigating to a Mark or a Route.

1. Press the **MENU** key, tap on **Navigation**.
2. Tap on **COMPASS**. The Compass page appears. Data Boxes on the Compass page can be customized, except for Latitude, Longitude, GPS Status, COG and BRG. Tapping anywhere on the screen brings up the **GPS SETUP** Soft Key.

- 1 Fix position
- 2 Time
- 3 Course Over Ground
- 4 Time To Go
- 5 WAAS/GPS Icon
- 6 Speed over Ground
- 7 Bearing to Destination
- 8 Distance to Destination
- 9 Compass Rose

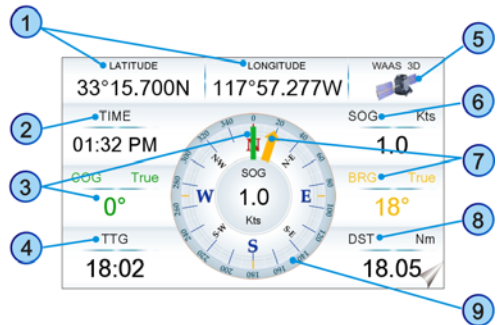

GPS Status page

This page is used as a reference to see how well the GPS is receiving satellites.

1. Press the **MENU** key, tap on **Navigation**.
2. Tap on **GPS**. The GPS Status page appears. Data Boxes can be customized, except for Latitude, Longitude and GPS Status.

- 1 Ship's Coordinates
- 2 Date and Time
- 3 WAAS/GPS Icon
- 4 Vertical Dilution of Precision
Horizontal Dilution of Precision
- 5 Tracked, but not used, Satellite
- 6 Used Satellite

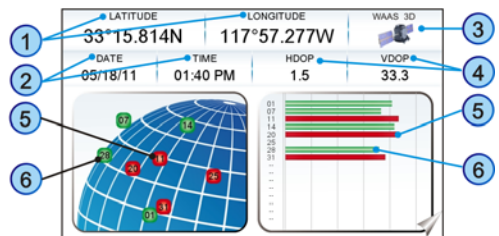

The WAAS/GPS Icon Area **3** may change due to the satellite reception:

| | |
|-------------------|--|
| ACQUIRING | : the GPS is trying to receive a valid position fix. |
| GPS2D | : the GPS is receiving at least 2 satellites. |
| GPS3D | : the GPS is receiving at least 3 satellites. |
| WAAS 2D/3D | : the GPS is receiving a 2D or 3D position and the correction from the WAAS satellite. |

GPS Setup Menu

From this page it is possible to activate the GPS Setup menu¹ following this procedure:

1. Firstly a tap anywhere on the screen for the Soft Keys to appear is needed (they are not displayed on the page by default and permanently). Then tapping on the **GPS SETUP** Soft Key brings up the GPS Setup menu¹. See the following table:

| | |
|-------------------------------|--|
| GPS Source | : Allows setting the GPS Source among Internal Antenna , External Antenna and Second CPN . The default setting is Internal Antenna. |
| Restart GPS | : Restarts all GPS processes. Once executed, the message "Done" is shown. |
| Navigation Speed | : Allows setting the Navigation Speed (SOG update) among Low and High . The default setting is High. |
| Speed Filter | : Allows to resolve erratic speed readings in rough seas. Available values are Off , Low , Medium , High . The default setting is Off. |
| Diff Correction Source | : Allows setting what kind of Differential Correction will be used by the GPS between WAAS/EGNOS and None . The default setting is WAAS/EGNOS. |

2. Tap on the preferred item.
3. Press the  key to exit the menu.

 The GPS Setup menu changes depending if the internal or external GPS is detected and switched on, and also can be different depending on the type of the external GPS used.

WAAS/EGNOS Setting

From the GPS Status page it is possible to disable the WAAS/EGNOS setting following this procedure:

1. Tap anywhere on the screen and then tap on the **GPS SETUP** Soft Key: the GPS Setup menu appears.
2. Tap on **DIFF CORRECTION SOURCE** to select **None** (to disable).
3. Press the  key to exit the menu.

2.13.5 NMEA PAGES

1. Press the  key, tap on **NMEA**. In the bottom of the page the available selections appear: **DIGITAL**, **ANALOG**, **COMBO** and **MONITOR**.

NMEA Digital page

The CPN Series Chart Plotter is capable of displaying information in the customizable data windows from external NMEA-0183 or NMEA-2000 devices, depending on which data source has been selected¹.

 To change the priority of the data source, NMEA-0183 or NMEA-2000, follow the procedure:

1. Press the **MENU** key, tap on **Setup Menu**.
2. Tap on **ADVANCED**. The Advanced Setup menu appears.
3. Tap on **DATA SOURCE PRIORITY**. The Data Source Priority menu appears.
4. If you want to change the data source with the highest priority, tap on the desired source and it is shown in the first position.

Depth Sounder, Speed Log with Temp, Wind Speed and Direction, Flux Gate Compass, and GPS information can be shown in any of the boxes.

! The NMEA-0183 sentences and the NMEA-2000 PGNs read from external devices are listed in the Chapter 8 "Specification".

To display the desired NMEA Digital page follow this procedure:

1. Press the **MENU** key, tap on **NMEA**.
2. Tap on **DIGITAL**. There are 6 NMEA Digital pages which can be displayed one after the other. They can display from 1 to 16 boxes and each data box can be customized. The default NMEA Digital shows 3 windows:

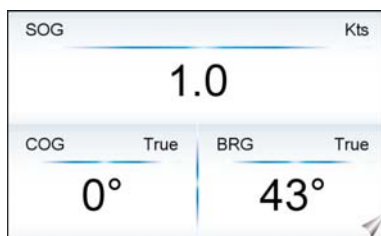

3. Move the **ShuttlePoint** knob to the left/right to scroll through all NMEA Digital pages, otherwise tap anywhere on this page for the Soft Keys to appear, and then tap on the desired Soft Key to select the NMEA Digital page you want. For example tap on the **6 BOXES** Soft Key to open NMEA Digital page with 6 boxes. See the following picture.



The 3 BOXES configuration is useful when navigating to a destination and trying to keep the Course Over Ground (COG) and Bearing (BRG) figures the same.

Customizing data boxes in the NMEA Digital page

To customize a data box please follow the procedure below:

1. Select a NMEA Digital page, then press and hold the **MENU** key. One of the data boxes will be highlighted in yellow, release the **MENU** key.

2. Tap on the box to be changed (see A) to show the menu popup window (see B).

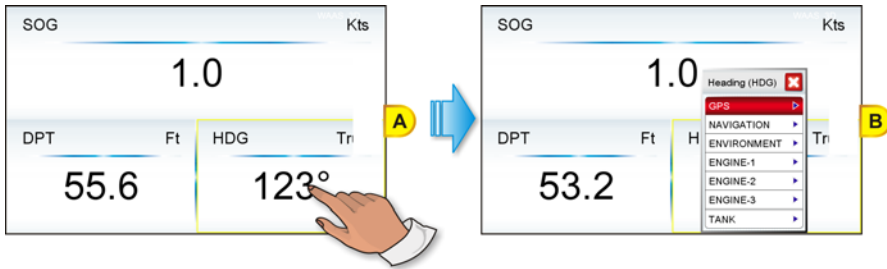

3. Tap on the desired group (**GPS**, **NAVIGATION**, **ENVIRONMENT**, **ENGINE-1**, **ENGINE-2**, **ENGINE-3** or **TANK**). Another popup window will be shown (see C).

ⓘ These are the default Engine names. To define the Engine names you want please see Par. 2.14.4 “Engines Name Selection”.

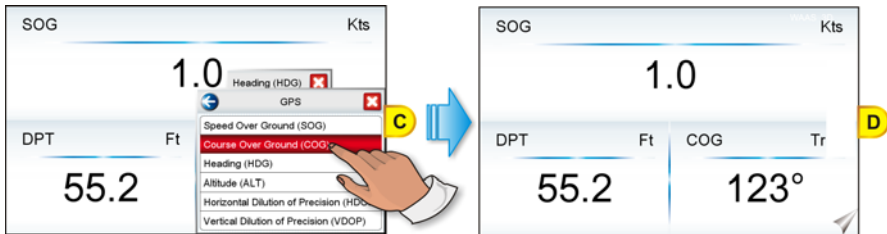

4. Tap on desired selection. Both menu popup windows will be closed, and the selection you made will appear in the desired box.
5. Press the **CLEAR** key one time so yellow highlight is removed from the data window (see D).

Analog page

The Engine pages allow you to display information in the form of analog gauges and data boxes.

1. Press the **MENU** key, tap on **NMEA**.
2. Tap on **ANALOG**.

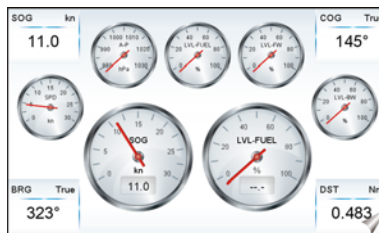

Both data boxes and gauges can be customized to show desired data. The procedure is as explained in the previous Paragraph “Customizing data box in the NMEA Digital page”. For some gauges it is also possible to select a desired range.

Engine & Chart (Combo) page

It is possible to set the Chart page and the Engine page on the same screen. Data boxes and gauges on this page can be also customized.

1. Press the **MENU** key, tap on **NMEA**.
2. Tap on **COMBO**.

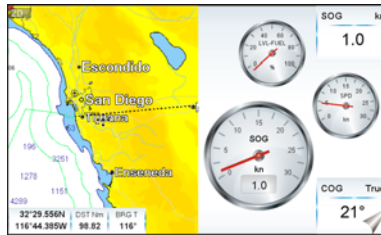

Monitor page

The Monitor page is very useful to see if an external device (for example a Depth Sounder) is transmitting NMEA-0183 or NMEA-2000 data to the CPN Series Chart Plotter.

1. Press the **MENU** key, tap on **NMEA**.
2. Tap on **MONITOR**. The display should look similar to the following picture:

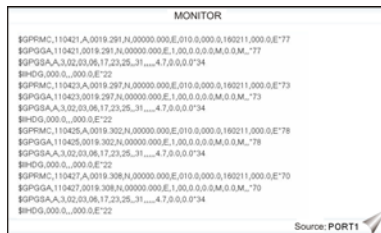

The currently selected source of data is shown in the bottom right corner of the page.

3. To view data from another port or device, tap anywhere on the page for the Soft Keys to appear.

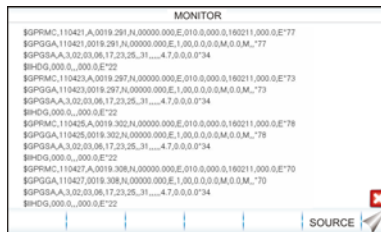

4. Tap on the **SOURCE** Soft Key. A window with available options will appear.
5. Tap on the desired port or device in the list.
6. To freeze the data on the display so it is easy to read and understand, press the **ShuttlePoint** knob or the **rotary knob**.
7. To unfreeze the data, the **ShuttlePoint** knob must be pressed again.

2.13.6 FISH FINDER (OPTIONAL FF525 REQUIRED)

The Fish Finder Icon and page selections may be accessed only when an optional FF525 is connected.

1. Press the **MENU** key, tap on **Fishfinder**. In the bottom of the page the available selections appear.
2. Tap on the right or left bottom arrow to scroll the Desktop Icons to display the desired icon. From the left:
 - **FULL 200kHz** opens the Fish Finder 200kHz Full page
 - **FULL 50kHz** opens the Fish Finder 50kHz Full page
 - **200kHz & CHART** opens the Fish Finder 200kHz page on the right side and the Chart page on the left
 - **50kHz & CHART** opens the Fish Finder 50kHz page on the right side and the Chart page on the left
 - **DUAL** opens the Fish Finder 200kHz page on the right side and the 50kHz page on the left
 - **ZOOM 200kHz** opens the Fish Finder 200kHz Zoom page
 - **ZOOM 50kHz** opens the Fish Finder 50kHz Zoom page
 - **AUTO** opens the Fish Finder 50/200kHz Zoom page.
3. Tap on the desired display. See the following example. For basic connections refer to Chapter 7 "Connections". For detailed installation and connections refer to the manual supplied with the FF525.



2.13.7 TIDE PAGE

1. Press the **MENU** key, tap on **Tide**. In the bottom of the page 2 available selections appear: **TIDE** and **FIND**.

Tides

The Tide page contains Tide information critical for safe navigation. It is also useful for boaters that are concerned about the height of the water under a bridge or by fisherman that wish to know the tide and moon phase of a specific date.

1. Press the **MENU** key, tap on **Tide**.
2. Tap on **TIDE**. The page appears and includes information on the moon phase with image, rise and set times and also rise and set times of the sun with an image of the sun. Moving the **ShuttlePoint** knob left and right controls the Tide Prediction time **1** (see the green vertical line which moves as the **ShuttlePoint** knob moves) and moving the **ShuttlePoint** knob up or down controls the Vessel Draft value **3** (see the orange

horizontal line which moves as the ● ShuttlePoint knob moves). The yellow vertical line

④ indicates current time and it is displayed only when receiving a fix.

- ① Tide Prediction Time
- ② Currently selected date
- ③ Vessel Draft value
- ④ Current Time

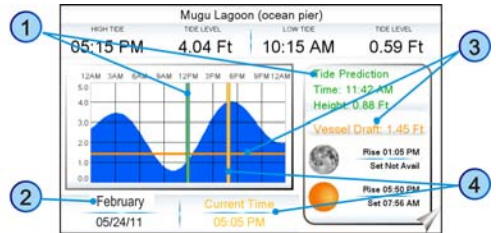

3. Tap anywhere on the screen for the Soft Keys to appear. Tap on the **STATION** Soft Key to open the Find Tide Stations which should find the 20 nearest Tide Stations. When a Tide Station is selected, the related information is displayed on the Tide page. Tap on the **DATE** Soft Key to enter the desired date.

❗ When activated from the Page Selection menu it displays information related to the fix position or to the cursor position.

None of the data boxes on this page can be customized.

2.13.8 VHF DIGITAL SELECTIVE CALLING

Digital Selective Calling is a semi-automated method of establishing a VHF radio call. DSC had also been designated as part of the Global Maritime Distress and Safety System (GMDSS).

This system allows mariners to instantly send a distress call with GPS position (when connected to the transceiver) to the Coast Guard or other vessels within range of the transmission. DSC will also allow mariners to initiate Position Request, Position Report Calls to or from another vessel equipped with a suitable DSC transceiver.

Compatible VHF Marine Radios with Digital Selective Calling are able to be interfaced with the CPN Series Chart Plotter to feed GPS data to the VHF as well as display DSC Calls on the CPN Series Chart Plotter:

1. A vessel that has transmitted a DSC Distress Call
2. A vessel that has transmitted a DSC Position Send Call
3. The position of a vessel that transmitted a DSC Position Request Call

NMEA-0183/NMEA-2000 Interfacing

To take advantage of these functions the CPN Series Chart Plotter must be interfaced (wired) to a STANDARD HORIZON or compatible DSC VHF. Refer to Section 7 "Connections" for connection example.

❗ DSC data can be received both from NMEA-0183 and NMEA-2000 relevant instruments, without any priority. In this mode the safety will be increased.

Distress Call

CPN Series Chart Plotters are able to display the location of a vessel in distress when interfaced to a compatible DSC VHF with NMEA-0183 or NMEA-2000 output and the radio receives a DSC Distress Call. CPN Series Chart Plotter also log DSC Distress Calls to review at a later date. To select the Distress Call page follow the procedure:

1. Press the **MENU** key, tap on **User Points**.
2. Turn the **rotary knob** until **DSC LOG** is highlighted and tap on it.

| DSC LOG - DISTRESS CALL | | | | | |
|-------------------------|--------------------------|---------------------|---------------|-----------------------------|-------|
| DATE TIME | NATURE OF | NAME MMSI | POSITION TIME | LATITUDE LONGITUDE | SHOWN |
| 03-03-01 08:31 PM | Disabled and adrift | PATTY 0080457645 | 08:31 PM | 33°30'505 N 118°18'529 W | NO |
| 03-04-01 00:11 PM | Undesignated distress | ROY 0023244524 | 00:11 PM | 33°34'167 N 118°21'864 W | YES |
| 03-04-01 08:31 PM | Collision | TOBI 0056477743 | 09:31 PM | 33°31'211 N 118°23'421 W | NO |
| | | | | | |
| | | | | | |
| | | | | | |
| | | | | | |
| | | | | | |
| | | | | | |
| | | | | | |
| | | | | | |

LOCATE DELETE DELETE ALL HIDE POSITION REQUEST

This page allows to:

- tap on **LOCATE**: centers the map on the selected DSC position
- tap on **DELETE**: deletes the selected DSC position
- tap on **DELETE ALL**: deletes all entries
- tap on **HIDE / SHOW**: allows hiding/showing the selected DSC position on the chart
- tap on **POSITION REQUEST**: allows selecting the Position Request page.

Position Request

CPN Series Chart Plotters are able to display the location of a vessel when connected DSC VHF radio and when a Position Request or Report Call is received. CPN Series Chart Plotter also logs DSC Distress Calls to review at a later date. To select the Position Request page follow the procedure:

1. Press the **MENU** key, tap on **User Points**.
2. Turn the **rotary knob** until **DSC LOG** is highlighted and tap on it.
3. Tap on **POSITION REQUEST**.

| DSC LOG - POSITION REQUEST | | | | | |
|----------------------------|-----------------------------|---------------------|--|--|-------|
| DATE TIME | LATITUDE LONGITUDE | NAME MMSI | | | SHOWN |
| 03-03-01 08:31 PM | 33°30'505 N 118°18'529 W | MINKO 0080457645 | | | NO |
| 03-04-01 00:11 PM | 33°34'167 N 118°21'864 W | ROY 0023244524 | | | YES |
| 03-04-01 08:31 PM | 33°31'211 N 118°23'421 W | TOBI 0056477743 | | | NO |
| | | | | | |
| | | | | | |
| | | | | | |
| | | | | | |
| | | | | | |
| | | | | | |
| | | | | | |
| | | | | | |

LOCATE DELETE DELETE ALL HIDE DISTRESS CALL

DSC Directory

CPN Series Chart Plotters are able to display the DSC Directory. From this page the user can assign the Vessel Name, Contact Name and Phone number to any MMSI (*Maritime Mobile Service Identity*) so that, when a DSC Distress Call or Position Request is received, the name of the vessel is displayed in place of the MMSI number (a unique number that is assigned to a DSC radio station for use in emergency situations).

Video image types for CPN700i

Full Screen View : Shows the image from the video camera at full screen.

PIP View : Shows the image from the video camera on the selected page.

Video image types for CPN1010i

Full Screen View 1 : Shows the image from the video camera 1 at full screen.

Full Screen View 2 : Shows the image from the video camera 2 at full screen.

PIP View 1 : Shows the image from the video camera 1 on the selected page.

PIP View 2 : Shows the image from the video camera 2 on the selected page.

2 Video Input Menu from Video Page Icon





1. Press the  key, tap on Page Icon **Video Input**.
2. Select the video image type: for CPN700i tap on **VIEW1** or **PIP1**, for CPN1010i tap on **VIEW1**, **VIEW2**, **PIP1** or **PIP2** as you want.

After the video image type has been selected, the CPN Series Chart Plotter will show a Warning message with the instructions to adjust the image from the Video Input: tap on  to close the Warning window and activate the video in.

- If Full Screen View was selected, the image from the video input will be shown.
- If Picture in Picture (PiP) View was selected, a Video Input image is shown on a window and placed over the selected page at full screen. By moving the  ShuttlePoint knob the PiP image is moved. Press any key to close the PiP image.



Video adjustment mode

Once the Video Input Mode is active, press the  key to enable the video adjustment mode and then use the following keys to adjust video settings:

- Press the  key to adjust backlight
- Move the  ShuttlePoint knob up/down to adjust brightness and left/right to adjust contrast
- Press the  key to adjust hue phase
- Press the  key to adjust saturation colors
- Any other key to exit Video Input Mode

Restore Defaults

The video default settings can be restored following the procedure below:

1. Press the  key, tap on **Setup Menu**.
2. Turn the  rotary knob or tap on the right bottom arrow to scroll the Desktop Icons to select **VIDEO** and tap on it. The Video Input menu appears.
3. Tap on **RESTORE DEFAULTS**.

2.13.10 ALARMS

1. Press the  key, tap on **Alarms**. At the bottom of the page the available selections appear: **SETUP**, **ENGINE**, **GROUNDING** and **SYSTEM**.

Alarms Setup menu

This menu is used to select and set up audible and visual alarms. See the following table:

| | |
|-------------------------------|---|
| Arrival Alarm: | Alerts when the vessel is approaching a single Destination point or a Waypoint in a Route. Available selections: 0.00 to 4.99Nm. The default setting is Off. |
| XTE Alarm: | Alerts when the vessel is deviating from a defined course. Available selections: 0.00 to 4.99Nm. The default setting is Off. |
| Depth Alarm: | Alerts when the received depth value from the optional FF525 50/200kHz BLACK BOX FISH FINDER inputting NMEA data into the CPN Series Chart Plotter is lower than the selected value. Available selections: 0000 to 3278ft. The default setting is Off. |
| Anchor Alarm: | Alerts when the vessel moves off from a selected location by a selected distance. Available selections: 0.00 to 4.99Nm. The default setting is Off. |
| Audible Alarm: | Enables or disables the alarm beep. The default setting is On. |
| External Alarm: | Enables or disables the External Alarm. When any alarm condition occurs the red wire is switched from High Impedance to Ground. When purchasing the optional buzzer, choose a 12VDC type with a Max current 400mA or less. The default setting is Off. |
| Grounding Alarm: | Looks ahead of the vessel's heading to see if a potential danger exists. When the Grounding Alarm is enabled the CPN Series Chart Plotter will draw a triangle in front of the vessel on the Chart page showing the area that is being searched (see below). The safe depth can be set using this function. The default setting is Off. |
| Grounding Alarm Range: | Sets the length of the sector to be detected among 0.25Nm, 0.5Nm and 1.0Nm. The default setting is Off. |



- ❗ The Grounding Alarm function checks the objects that belong to the standard charts. It does not check the objects belonging to the VAD categories.
- ❗ The Grounding Alarm function is available only if a C-MAP 4D SD CARD is inserted. It also affects the screen redraw speed so we suggest to disable it when not used.
- ❗ When any of the objects checked are found for the first time, the CPN Series Chart Plotter shows a pop up window to alert the user of the possible danger. The name of each new dangerous object found is reported in the warning window. In the Grounding Alarm Report page the relative item has a check mark next to it, to identify the dangerous object currently detected. If in the next search cycle the same objects are found again, the alarm window will not be shown. Instead, if in the next searches the objects found before are no longer detected, their relevant item in the Grounding Alarm Report page is cleared (note that in this case, if the same object type is found again later, the Alarm will be shown). The CPN Series Chart Plotter shows an icon on the charts that identifies when a Grounding Alarm is detected.

Engine Alarm Report

This menu is used to display the Engine Alarm Report on ENGINE-0¹, ENGINE-1¹ and ENGINE-2¹. These alarms cannot be disabled or enabled by a user; they appear when a NMEA-2000 sentence with warning information is received (of course these alarms work only when engines are connected to NMEA-2000 bus). In the table a check mark is printed on the relative box. Once the alarm condition is no longer present, the relative check mark

is removed. Here is the list of all possible alarms:

- CHECK ENGINE
- OVER TEMPERATURE
- LOW OIL PRESSURE
- LOW OIL LEVEL
- LOW FUEL PRESSURE
- LOW SYSTEM VOLTAGE
- LOW COOLANT LEVEL
- WATER IN FUEL
- WATER FLOW
- HIGH BOOST PRESSURE
- REV LIMIT EXCEEDED
- EGR SYSTEM
- THROTTLE POSITION SENSOR
- ENGINE EMERGENCY STOP MODE
- WARNING LEVEL 1
- WARNING LEVEL 2
- POWER REDUCTION
- MAINTENANCE NEEDED
- ENGIN COMM ERROR
- SUB OR SECONDARY THROTTLE
- NEUTRAL START PROTECT
- ENGINE SHUTTING DOWN



These are the default Engine names. To define the Engine names you want please see Par. 2.14.4 "Engines Name Selection".

Grounding Alarm Report

Displays the report of the dangerous objects currently detected. When any of the searched objects is found in the scanned area, a check mark is printed on the relative box to identify which dangerous objects have been currently detected. Once the alarm condition is no longer present, the relative check mark is removed.

System Alarm Report

Displays the report of the four alarms: Arrival Alarm, Anchor Alarm, XTE Alarm and Depth Alarm. When one of these alarms exists, a check mark is printed on the relative box. Once the alarm condition is no longer present, the relative check mark is removed.

2.14 ADVANCED SETTINGS

The Advanced Setup menu allows customization of many GPS functions and NMEA interfacing.

1. Press the  key, tap on **Setup Menu**.

2. Tap on **ADVANCED**. While in this menu you will see many selections which are described in the next sections.

2.14.1 NAVIGATE MENU

The Navigate menu allows customization of the Coordinate System (Loran TDs), Chart Datum, Chart Orientation Resolution (angle the vessel has to change before the chart is redrawn) and Static Navigation. See the following table:

| | |
|-------------------------------|---|
| COORDINATE SYSTEM: | Selections are: a. TD : Time Difference, based on Loran b. UTM : Universal Transverse Mercator Grid c. ddd mm.mmm : Degrees Minutes and Thousandths of Minutes d. ddd mm.mm : Degrees Minutes and Hundredths of Minutes e. ddd mm.ss : Degrees Minutes and Seconds |
| CHART DATUM: | Allows selection of Chart Datums. The default Datum is WGS 1984 as C-MAP BY JEPPESEN cartography has been compiled using the WGS84 Datum. A datum is a mathematical model of the earth which approximates the shape of the earth, and enables calculations such as position and area to be carried out in a consistent and accurate manner. |
| CHART ORIENTATION RES: | Sets the angle the vessel has to change before the chart is redrawn. The default setting is 30°. Example: if the vessel is heading 000T at a speed of 25 Knots, the display will redraw: a. In Home Mode the CPN Series Chart Plotter centers the location of the vessel in the center of the display while it is displayed in the center or on the bottom of the screen (depending on the setting). To keep the vessel in the center of the display the CPN Series Chart Plotter will occasionally redraw. b. If the vessel changes course greater than 330T or more than 30T the chart will be redrawn. |
| STATIC NAVIGATION: | Sets up a threshold for the speed. When the speed received from the GPS is under the selected value, the CPN Series Chart Plotter displays zero. |

Loran TD

The Loran TDs selection allows the CPN Series Chart Plotter to be set up so the user can enter in LORAN TDs directly into the CPN Series Chart Plotter. After the TDs have been entered, and the user changes to ddd mm.sss (Degrees Minutes and Seconds) the TDs will be converted to Lat/Lon coordinates. To use the TD Coordinate System the user must set up the Chain and Pair information of the TDs. If you do not know this information, refer to paper charts that show the Chain and Pair information. See the following table:

| | |
|----------------|---|
| CHAIN: | Selects the Chain. |
| PAIR: | Selects the Pair. |
| ASF1/2: | Additional Secondary phase Factor Correction to TD1/2 values which can be inserted by the user to take into account the additional signal propagation delay over a mixed land/seawater path compared to an all-seawater path. Normally the user does not enter a ASF value. However for experienced users this function allows entering of signal delay values to fine adjust the calculated position. The user should enter delay values to fine adjust the position calculated. |
| Alter: | Alternate Solution Parameter selected by the user that is applied in the conversion of geographical coordinates Lat/Lon to TD values. To be used if the position displayed is roughly not correct. |

2.14.2 COMPASS (COG) SETUP

The CPN Series Chart Plotter computes compass direction from the constellation of GPS

Satellites. For the CPN Series Chart Plotter to compute direction the vessel must be moving through the water to show a COG value. To show the vessels heading when the vessel is not moving an optional NMEA Heading Sensor (fluxgate compass) must be connected. The Compass menu allows the CPN Series Chart Plotter to customize the following selections:

- BEARINGS:** Selects between **True** and **Magnetic**. When Magnetic bearing is enabled, the CPN Series Chart Plotter applies the selected Magnetic Variation (Auto or Manual, see next item) to compute Magnetic bearing.
- VARIATION:** Allows the user to select **Auto** or **manual**. When Auto mode is selected the CPN Series Chart Plotter computes the offset by the current GPS fixed location. Manual mode allows the user to enter in a magnetic variation that is applied in the True conversion.
- CALIBRATION:** Allows a user to enter an offset for areas that the vessel may cruise instead of entering in a manual offset for one location. This offset is useful for cruising vessels or vessels that travel internationally often.

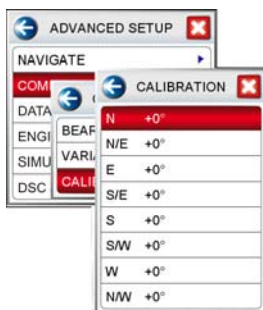

2.14.3 DATA SOURCE PRIORITY SELECTION

It is possible to set the priority of the input data source for GPS, Depth, Wind and Compass. For each group you can decide on the source of data with the highest priority, setting this data source to be number 1. This means that if the system does not receive data from devices sending it to data source number 1, it will try to read data from devices connected to the other data source, which is set as number 2 in priority.

The kind of data types in each group are:

- GPS : Position, SOG, COG, Date, Time, GPS signal parameters
- DEPTH : Depth, Speed Through Water, Water Temperature
- WIND : Speed and Direction
- COMPASS : Heading, Variation, Rudder Angle

The priority data source can be set following the procedure below:

1. Press the **MENU** key, tap on **Setup Menu**.
2. Tap on **ADVANCED**. The Advanced Setup menu appears.
3. Tap on **DATA SOURCE PRIORITY**. The Data Source Priority menu appears.
There are 4 groups, GPS, DEPTH, WIND and COMPASS. In each group the top item (indicated with "1") shows the data source with the highest priority for the related group. For example in the following picture A, the input data source with the highest priority for GPS is NMEA-0183: **1: NMEA-0183**. But if the system does not receive GPS data from devices sending it to NMEA-0183 input, it will try to read this data from devices connected to NMEA-2000 bus, which is set as a second in priority: **2: NMEA-2000**.
4. If you want to change the priority data source, tap on the desired source and it is shown in the first position. For example tap on **1: NMEA-0183** and then in the following picture B the input data source with the highest priority for GPS changes to NMEA-2000.

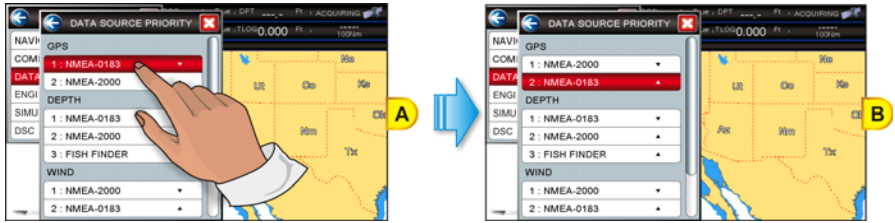

2.14.4 ENGINES NAME SELECTION

The Engines submenu allows you to name each instance of an Engine which is connected to the NMEA-2000 bus. These names are displayed in gauges, in data boxes, in the data box customization menu and in the Engine Alarm Report. The default Engine names are set to "1", "2" and "3". To name the Engines follow the procedure below:

1. Press the **MENU** key, tap on **Setup Menu**.
2. Tap on **ADVANCED**. The Advanced Setup menu appears.
3. Tap on **ENGINES**. The Engines menu appears.



4. Tap on **ENGINE NAME** that you want to edit. The touchscreen keyboard appears, it will allow you to enter in the name of the Engine. Insert the desired name (6 characters long); when finished tap on , the keyboard disappears.

2.14.5 INPUT/OUTPUT (NMEA-0183) CONNECTIONS

Refer to Chapter 7 "Connections" for wire description and connection examples.

Input/Output

The CPN Series Chart Plotter has 3 NMEA-0183 inputs and 4 NMEA-0183 outputs. These Ports may be set up to receive and output the following:

- **NMEA-0183** - NMEA-0183 devices¹ set to 4800 Baud (default setting)
- **GPS Auto** - External GPS devices of unknown or different than 4800 Baud. The system will automatically detect connected GPS's Baud Rate and will allow correct communication with this device.
- **Fish Finder** FF525 50/200kHz BLACK BOX² - refer to Fish Finder Owner's Manual
- **AIS 38400** - AIS Receiver
- **Disabled** - allows the port to be disabled.

¹ RS232 not opto-isolated electrical interface.

² Not available on Port4.

NMEA-0183 Output sentences

The ports may be setup to output NMEA-0183 sentences. The table below shows the default setting for each port:

| Sentence | Port1 | Port2 | Port3 | Port4 |
|----------|-------|-------|-------|-------|
| GLL | On | On | On | On |
| VTG | Off | Off | Off | Off |
| BWC | Off | Off | Off | Off |
| WCV | Off | Off | Off | Off |
| APA | Off | Off | On | Off |
| APB | Off | Off | On | Off |
| HDG | Off | Off | Off | Off |
| BOD | Off | Off | On | Off |
| XTE | On | On | On | On |
| RMA | Off | Off | Off | Off |
| RMB | Off | Off | Off | Off |
| RMC | On | On | On | On |
| GGA | On | On | On | On |
| HSC | Off | Off | Off | Off |
| DBT | On | Off | Off | Off |
| DPT | On | Off | Off | Off |
| MTW | On | Off | Off | Off |
| VHW | On | Off | Off | Off |
| GSA | On | Off | Off | Off |
| GSV | On | Off | Off | Off |

2.14.6 SIMULATION



The built-in Simulator function allows you to become proficient in the use of the CPN Series Chart Plotter. No current position fix is required because the CPN Series Chart Plotter simulates position data internally.

| | |
|-------------------------|---|
| Simulation Mode: | Three selections: Off: turns the Simulation Mode off On: enables the Simulation Mode, where the speed and course are adjusted by entering in values in the Course and Speed selection discussed later in this table Route: allows you to navigate to a saved Route |
| Course: | Allows entry of simulated course. |
| Speed: | Allows entry of simulated speed. |
| Date: | Allows entry of simulated date. |
| Time: | Allows entry of simulated time. |
| Cursor Control: | Enables (On)/disables (Off) the Cursor Control. Moving the  ShuttlePoint knob up or down will change the SOG and left or right will change the COG of the simulated vessel. |
| Demo Mode: | In Demo Mode the CPN Series Chart Plotter automatically places a Destination point on the Chart page in the cursor location and simulates navigation to the point. Also, the page changes automatically every 10 seconds. The pages are shown in the following order: Main Menu pages, General Chart page, Highway page, Compass page, Tide page, Chart/Fish Finder, GPS Status page, Chart pages, Engine pages. Once the Demo Mode is enabled, pressing any key temporarily exits and returns to CPN Series Chart Plotter normal operation, but if you do not touch any key for 30 seconds Demo Mode restarts. |

Navigating a Route in Simulation Mode

This selection allows you to navigate to a saved Route to see how data windows on the Chart

page and how the Navigation and Highway pages operate.

1. Create a Route.
2. Press the  key, tap on **Setup Menu**.
3. Tap on **ADVANCED**. The Advanced Setup menu appears.
4. Tap on **SIMULATION**. The Simulation menu appears.
5. Tap on **SIMULATION MODE**.
6. Tap on **Route**. A window with the Route(s) that are stored in the CPN Series Chart Plotter's memory appears.
7. Tap on the desired Route.
8. Tap on **SPEED**.
9. The touchscreen keyboard appears. Enter in the speed you want the vessel to travel at in Simulation Mode; when finished tap on , the keyboard disappears.
10. Tap on  to exit to the last selected page.

2.14.7 DSC POLLING

This menu is used to enable or disable features related to the DSC function.

Auto Position: Selects between Manual and Auto. When Auto Position item is set to **Manual** and the CPN Series Chart Plotter receives a DSC Position Request or Distress Call from a connected VHF radio, a popup window will not be displayed. When the Auto Position is set to **Auto**, the CPN Series Chart Plotter works as follows:

- a : when receiving the DSC Distress or Position Request, a popup window is displayed;
- b : if **VIEW ON CHART** is selected, the position is indicated on the chart marked with "P" or "D". The cursor is moved to the point "P" and shows the point in the center of the screen;
- c : when moving the cursor from "P", the location can be confirmed. At this time, the same MMSI Position Request data that was received before are remaining and displayed.

Auto Info: Enables or disables the Auto Info. This selection is available only when Auto Position is set to Manual. If Auto Info is set to On, when receiving the Position Request it is possible to center the cursor over the top of the Position Request icon and show the Position Request popup window

2.14.8 ABOUT PAGE

The About page contains software, chart and optional devices information. To select the About page follow the procedure below:

1. Press the  key, tap on **Setup Menu**.
2. Tap on the right bottom arrow to scroll the Desktop Icons to display **ABOUT** and tap on it. The About page appears on the screen (see A).
3. Tap anywhere on the screen to display the Soft Keys on the bottom of the page (see B):
 - The **UPDATE FF** Soft Key starts Fish Finder firmware update procedure.
 - The **LICENSE** Soft Key opens the License page which lists the legal information as copyright and license type. Use the **PREV** and **NEXT** Soft keys to scroll the page and the **CLOSE** Soft Key to exit and return to the About page.
 - FOR NORTH AMERICA USERS ONLY: the **SAVE ID** Soft Key saves the Built-In Charts to an optional SD CARD for updating purposes.
 - The **DAM REPORT** Soft Key opens the Data Access Manager Report page
 - The **REMOVE SD** Soft Key starts the Safely Remove Data Cartridge procedure (see Par. 2.3 "Removing the SD CARD").

UNIT ID code for updating Built-In Charts Software System Information Cartography Information

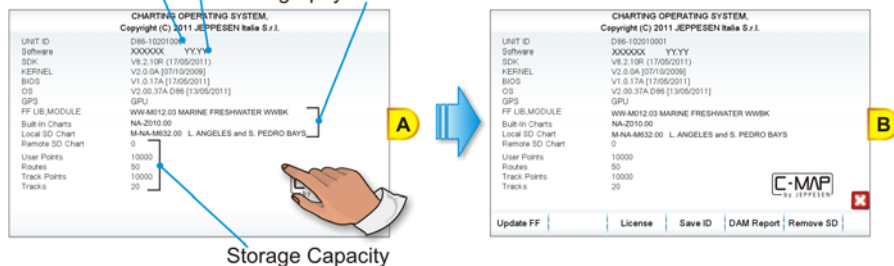

⚠ In the previous picture UNIT ID code is for North America users only.

4. Press the **CLEAR** key to close the About page.

DAM Report page

The DAM (Data Access Manager Report for Optional 4D cartography) Report page contains details about the Subscription, Expiration Date and Data/Features Segmentation status of the C-MAP 4D data cartridge.

1. From About page with Soft Keys shown, tap on the **DAM REPORT** Soft Key (see A): the Data Access Manager Report page appears (see B).

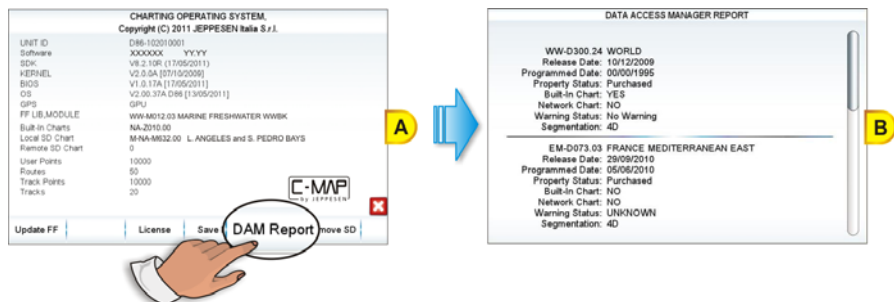

2. Press the **CLEAR** key to close the DAM Report page and to go back to the About page. In the DAM Report page the following information is displayed for each chart:

- **Code and Name:** shows the unique code and the name of the chart.
- **Release Date:** is the date when the chart was produced and issued.
- **Programmed Date:** is the date when the chart was programmed on the memory support and the relative chart License was generated.
- **Property Status:** indicates if the chart is rented or sold or other:
 - Purchased** (the cartridge is always enabled)
 - Rental** (the cartridge is enabled until it expires)
 - None** (the purchase type is not defined)
- **Built-In Charts¹:**
 - Yes** (the chart is stored in the CPN Series Chart Plotter memory, it could be also in the remote CPN Series Chart Plotter)
 - No** (the chart is on an external device, i.e. SD CARD)

- **Networked Chart:**
 - Yes** (the chart is on the remote CPN Series Chart Plotter)
 - No** (the chart is on the local CPN Series Chart Plotter)
- **Warning Status:** reports the specific warning message about the chart's data.
- **Segmentation:** is the kind of data available: 4D, MAX, BASE, invalid chart, currently content not supported.

 For North America users only.

2.15 AIS

AIS is an Automatic Identification System. It has been introduced to improve the safety of navigation by assisting in the efficient operation of ship-to-ship location reporting and VTS applications. The system should enable operators to obtain information from the ship automatically, requiring a minimum of involvement of ship's personnel, and should have a high level of availability. AIS transponders installed on IMO vessels use VHF frequencies to:

- Transmit details of their own vessel
- Receive details from other vessels or navigation aids within VHF range.

CPN Series Chart Plotters are able to display AIS Targets (for collision avoidance) on the Chart page and AIS List pages when connected to an AIS Receiver (GX2100 or GX2150 STANDARD HORIZON VHF/AIS transceiver) or transponders which output NMEA-0183 VDM sentence at 38400/4800 baud, or output NMEA-2000. The CPN Series Chart Plotters are able to show Targets from both Class A (commercial) and Class B Targets.

 AIS data can be received both from NMEA-0183 and NMEA-2000 relevant instruments, without any priority. In this mode the safety will be increased.

2.15.1 SYSTEM DEFINITIONS

- **Target:** vessel equipped with AIS. Information about the Targets is being received by AIS Receiver and displayed on the screen.
- **CPA (Closest Point of Approach):** the closest distance that will be achieved between your vessel and the tracked Target, based on your vessel's speed and direction and the Target's speed and direction.
- **CPA Limit:** distance from your vessel that a Target may reach before a Target is deemed a threat.
- **CPA Alarm:** occurs if CPA is less or equal to CPA Limit. This test is done for active Targets only.
- **TCPA (Time to Closest Point of Approach):** time remaining until the CPA will occur.
- **TCPA Limit:** time remaining before the CPA is reached.
- **TCPA Alarm:** occurs if TCPA is less or equal to TCPA Limit. This test is done for active Targets only and if CPA value is less or equal to CPA Limit.
- **Radio Call Sign:** international call sign assigned to vessel, often used on voice radio.
- **Name:** name of ship, 20 characters.
- **MMSI (Maritime Mobile Service Identity) number:** a unique 9 digit number that is

assigned to a DSC radio station. It primarily registers the boat information in the U.S. Coast Guard's national distress database for use in emergency situations.

- **Active Target:** Target located within the Activation Range. Active Targets are represented by oriented triangle with COG and Heading vectors. Rate of turn may also be displayed.
- **Dangerous Target:** Target detected by CPA or TCPA Alarm. Dangerous Targets are Active Targets by definition. For better visibility Dangerous Target symbol is flashing.
- **Sleeping Target:** Target located outside the Activation Range. Sleeping Targets are represented by a small oriented triangle.
- **Lost Target:** When the AIS info is not received from that vessel for 3.5 minutes. The presentation will be a flashing black triangle with a cross through.
- **Activation Range:** Range around your boat where targets become active. AIS Targets become active within this range. Activation Range should be greater than CPA Limit by definition.



A Target is removed from the screen if data is not received for 10 minutes. The maximum number of tracked Class A or B Targets is 200. This information is updated every 3 seconds to 6 minutes depending on speed and rate of turn, enabling the track of the vessels in range to be plotted.

| TARGET STATUS | DESCRIPTION | SYMBOL |
|------------------|--|--------|
| ACTIVE TARGET | Target located within the Activation Range. | |
| DANGEROUS TARGET | Target detected by CPA or TCPA Alarm. Dangerous Target is Active Target by definition. | |
| SLEEPING TARGET | Target located outside the Activation Range. | |
| LOST TARGET | Ais info is not received from that vessel for 3.5 minutes. | |

2.15.2 AIS SETUP MENU

To configure the CPN Series Chart Plotter to receive AIS data, follow the procedure:

1. Press the key, move the ShuttlePoint knob or tap on the right top arrow to scroll the Pages Icons to display **AIS** and tap on it.
2. Tap on **AIS SETUP**. The AIS menu appears. The available functions are described in the following table:

| | |
|----------------------------|---|
| Display | : Turns the display of AIS Targets overlay on the cartography On or Off. |
| Activation Range | : Defines the range from the fix within which the AIS Target becomes active. The values allowed are from 0.1 to 20Nm. |
| CPA Alarm | : Turns On or Off the alarm. |
| CPA Limit | : The values allowed are from 0.1 to 10Nm. |
| TCPA Alarm | : Turns On or Off the alarm. |
| TCPA Limit | : The values allowed are from 1 to 30 Min. |
| SART/MOB/EPIRB Test | : Turns On or Off receiving of AIS-SART, AIS-MOB or AIS-EPIRB test alerts. |

2.15.3 QUICK INFO ON AIS TARGET

Tap on an AIS Target icon, the following information is displayed.



The selected AIS Target icon is surrounded by a square frame when user places the cursor over the icon.

- 1 Vessel name
- 2 MMSI number
- 3 Speed Over Ground
- 4 Closest Point of Approach
- 5 Radio Call Sign
- 6 Course over Ground
- 7 Time to Closest Point of Approach
- 8 Vessel Type

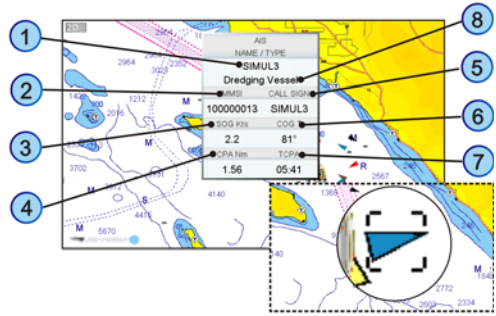

2.15.4 AIS TARGET COLORS





The received AIS Targets are shown in color. The color depicts the type of AIS ship shown on the Chart page. Refer to following table.

| TYPE OF SHIP | GRAPHICAL PRESENTATION |
|--|------------------------|
| Undefined | ▲ (yellow) |
| Fishing | △ (white) |
| Pleasure Craft | ▲ (light green) |
| Tanker | ▲ (dark blue) |
| Pilot Vessel | △ (light gray) |
| SAR | ▲ (black) |
| Tug | △ (pale green) |
| Port tenders | ▲ (brown) |
| Vessels with antipollution facilities or equipment | ▲ (light blu) |
| Law enforcement vessels | ▲ (light red) |
| Medical transport | ▲ (dark green) |
| Vessels according to Resolution N° 18 (Mob-83) | ▲ (cyan) |
| HSC | ▲ (red) |
| Passenger ship | ▲ (magenta) |
| Cargo ship | ▲ (dark gray) |

2.15.5 AIS-SART

AIS-SART, AIS-MOB and AIS-EPIRB signals are all emergency signals sent out by different types of survivor locating devices.

When an AIS-SART, AIS-MOB or AIS-EPIRB signal is received, the CPN Series Chart Plotter displays and sounds a dedicated alarm. It also displays such objects on the Chart page like any other AIS objects but with dedicated icons, depending on the current status of the emergency signal (see the following table).

| | | | | |
|---------------|--|--|--|--|
| ICON |  |  |  |  |
| SIGNAL | SART AIS-MOB EPIRB } Active | SART AIS-MOB EPIRB } Test | SART AIS-MOB EPIRB } Active lost | SART AIS-MOB EPIRB } Test lost |

AIS-SART Test mode

The CPN Series Chart Plotter by default ignores test AIS-SART, AIS-MOB and AIS-EPIRB signals in order to avoid a large number of alerts. However the CPN Series Chart Plotter can be enabled to receive test alerts (see Par. 2.15.2 “AIS Setup Menu”) if you want to test them.



2.15.6 AIS LIST

The AIS List page shows basic information of the Target ship with the ability to select a Target ship and locate it on the chart.

AIS Targets are sorted by distance from current fix position: the closest Targets are displayed at the top of the list. AIS-SART, AIS-MOB and AIS-EPIRB objects are also listed on this page and are also sorted by distance.



 When the received Targets exceed the maximum limit allowed for the list, the closest Targets (which could be potentially the most dangerous) will be kept in memory and the farthest (potentially less dangerous) will be lost.

To select this page follow the procedure:

1. Press the  key, move the  ShuttlePoint knob or tap on the right top arrow to scroll the Pages Icons to display **AIS** and tap on it.
2. Tap on **AIS LIST**. The AIS List page appears:

| AIS LIST | | | | | | | |
|----------|-----------|----------|-----------|---------|-------|---------|---------|
| NAME | CALL SIGN | MMSI | MO NUMBER | SOG Pkt | COG T | CPA Min | TCPA |
| SIMUL5 | SIMUL5 | 10000005 | 10000008 | 2.0 | 190° | 0.96 | ---:--- |
| SIMUL8 | SIMUL8 | 10000008 | 10000011 | 2.0 | 143° | 1.10 | 05:48 |
| SIMUL4 | SIMUL4 | 10000004 | 10000007 | 1.5 | 140° | 2.58 | ---:--- |
| SIMUL9 | SIMUL9 | 10000009 | 10000012 | 1.8 | 29° | --- | --- |
| SIMUL1 | SIMUL1 | 10000001 | 10000004 | 1.0 | 300° | --- | --- |
| SIMUL2 | SIMUL2 | 10000002 | 10000005 | 3.4 | 22° | --- | --- |
| SIMUL3 | SIMUL3 | 10000003 | 10000006 | 3.4 | 64° | --- | --- |
| SIMUL6 | SIMUL6 | 10000006 | 10000009 | 4.0 | 158° | --- | --- |



3. Move the  ShuttlePoint knob up/down to select the Target and scroll the page up/down.
4. Tap on  to show the Target ship on the Chart page along with the current position of the CPN Series Chart Plotter.
5. Otherwise press the  key to exit the page.

2.16 C-MAP WEATHER FORECASTS SERVICE

C-MAP Weather Forecasts Service is a **free** worldwide service available on the CPN Series Chart Plotter. Weather Forecasts are based on data received from the European Centre for Medium-Range Weather Forecasts (ECMWF). To display C-Weather data on the CPN Series Chart Plotter simply download the weather data via the chart plotters built-in Wi-Fi®, if a Wi-Fi® connection is not present onboard your vessel, download the C-Weather data at home using the C-MAP BY JEPPESEN PC-Planner Windows Application by saving the data to an SD CARD to be loaded on to the CPN Series Chart Plotter.

The advanced features of the C-MAP Weather Forecasts Service include:

- 5-day Weather Forecast updated every 3 hours
- Coverage of 180x180Nm with information frequency of 0.5° Lat/Lon
- Wind Direction and Wind Speed
- Wave Height and Wave Direction
- Air Temperature
- Level of Humidity
- Visibility in miles and weather type

ⓘ The units of measure are set by the user, see Par. 2.1.4 “Settings in General Setup Menu”.

| | | | | | |
|------------------|-----------------------|------------------------|-------------|-----------------|------------|
| DISPLAY | - 0 → | - 1 → | 18° | 30 | 20 |
| DATA TYPE | WIND (Speed & Dir) | WAVE (Height & Dir) | TEMPERATURE | HUMIDITY (%) | VISIBILITY |

| | | | | | | | |
|---------------------|---|---|---|---|---|---|---|
| DISPLAY |  |  |  |  |  |  |  |
| WEATHER TYPE | Sun | Rain | Fog | Snow | Clouds | Partly Cloudy | Thunderstorm |

2.16.1 C-MAP WEATHER PAGE

To select the C-Weather page:

1. Press the **MENU** key, tap on **Chart**.
2. Tap on **C-WEATHER**. The C-MAP Weather page appears:



Change Time

Change displayed data type

Download C-Weather data from Internet

Change date

Download C-Weather data from SD CARD

Downloaded data is shown directly on the chart and detailed information about each data is displayed in a dedicated window.

ⓘ C-Weather page can be exited like any other page by: going to the Main Menu and choosing a different page; selecting a different page from the Page Change Icon; sweeping to the next or previous page (see sub-paragraph “Pages Selection” in the Par. 2.1.3).

Download via Wi-Fi® connection

Allows loading of the C-MAP Weather data package from Internet. Downloading a new set of C-Weather data will overwrite data already stored in internal memory.

ⓘ Download is possible only if Wi-Fi® connection is set and an Internet connection is available. If not, please go to Connection Manager and establish connection manually (see Chapter 3 "Connection Manager").

To activate the direct download of C-Weather data, please follow the procedure below:

1. Tap on the **DOWNLOAD** Soft Key (see A). The whole data package (see the previous Weather data package table) will be downloaded.
2. An Information window appears (see B). The download will start for the area around the current cursor location. Once the download procedure is started, it will not be possible to move the cursor and change the download area.
3. When download is completed, press the **CLEAR** key to close the Information window.



Download from SD CARD

Using the C-MAP BY JEPPESEN PC-Planner Windows Application it is possible to save C-Weather data on a User SD CARD (for more information on a User SD CARD please refer to Par. 2.12 "User SD CARD"). The weather data saved on the User SD CARD can be loaded into the CPN Series Chart Plotter following the procedure below. Loading a new set of C-Weather data will overwrite data already stored in internal memory.

1. Insert the User SD CARD contained the weather data into the slot.

ⓘ If there is a SD CARD inserted into the slot, before following the loading procedure, please safely remove it using the procedure described in the Par. 2.3 "Removing the SD CARD".

2. Press the **MENU** key, tap on **Chart**.
3. Tap on **C-WEATHER**. The C-MAP Weather page appears.
4. Tap on the **SD CARD** Soft Key (see A).

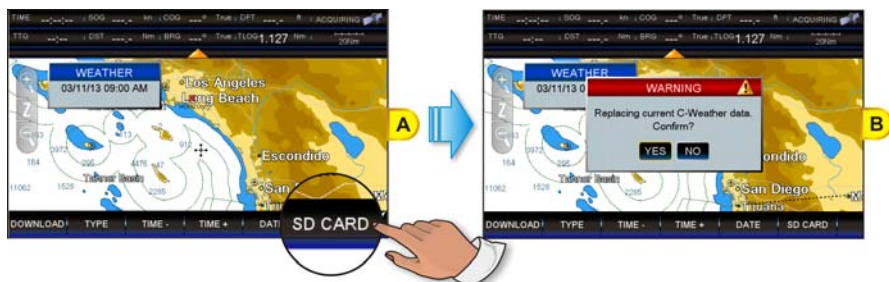



- A Warning window is shown, to confirm to replace the current C-Weather data (see B). Tap on **YES**.
- An Information window is shown, to inform the uploading is done. Tap on **OK** to close the Information window.

Forecast

Allows selecting the layer of specific weather data to be displayed on the C-Weather page and to change date and time of the forecast preview.

- ! By default the C-Weather Forecast is displayed over 2D Vector chart, but you can change this mode (see Par. 2.5.1 "4D Functions").

The following functions are available:

- Panning:** default usage of the cursor key is the normal panning function.
- Zoom in/out:** zoom in/out functions are allowed as usual by using  .

- ! Zooming and panning are allowed and accessible as like on any other Chart page. In fact C-Weather page behaves like any other Chart page, but quick info on cartographic object and User Points does not work.

- Set forecast date:** tap on the **DATE** Soft Key (see A). A window appears with all available date values (see B) and allows choosing the desired one.

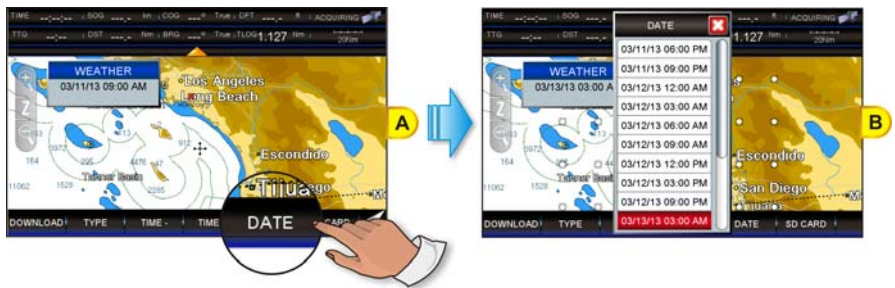

- Set forecast time:** the **TIME +** and **TIME -** Soft Keys allow to modify time values.
- Change data type:** tap on the **TYPE** Soft Key (see A) to change the data type displayed on the screen. It opens an option window with all available data types (see B) and allows choosing the desired one.



3 - CONNECTION MANAGER



3.1 GETTING STARTED

The Getting Started section will take you through frequently used operations using the Connection Manager. The Connection Manager allows you to connect to a Wi-Fi® Hotspot and to share information between two CPN Series Chart Plotters.

3.2 STARTING THE CONNECTION MANAGER

There are two ways to access the Connection Manager, follow the procedure below:

1 From the Chart Plotter Mode

1. Press and hold the  PWR key until the display shows the window below:



2. Tap on  to display the Startup Screen page.

2 From the Startup Screen page

1. Turn on the CPN Series Chart Plotter.
2. When the Startup Screen page is shown, tap on the Connect Icon  (see A).

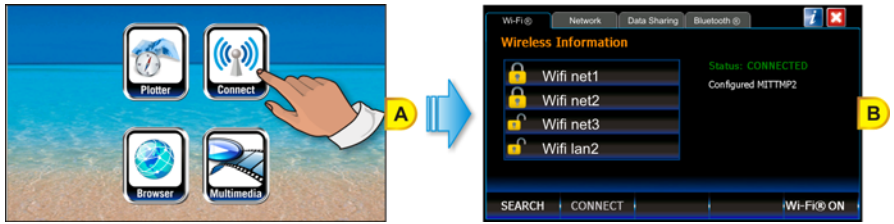

3.3 CONNECTION MANAGER OVERVIEW

The first time the Connection Manager is opened, the following window is displayed:

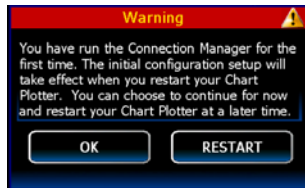

3.3.1 Wi-Fi® CONNECTION

The Wi-Fi® tab lists the available Hotspots found by the CPN Series Chart Plotter (see the picture below) and allows connection to a desired Hotspot.

- 1 The status can be:
CONNECTED (green)
NOT CONNECTED (red)
CONNECTING... (yellow)
- 2 Signal Strength: appears only if a Wi-Fi® Hotspot is selected. Red bar indicates a very low to low signal strength and a Green bar indicates good to excellent signal strength
- 3 Locks: open=🔓 no encryption Network closed=🔒 Network (Wi-Fi® password) key required
- 4 Available Wi-Fi® Networks Automatically refreshed
- 5 Soft Keys

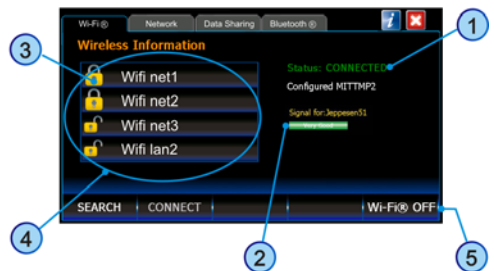















3.3.2 WI-FI® STANDARDS SUPPORTED



The CPN Series Chart Plotter is certified to work with the following standards on the basis of the Wi-Fi® Alliance specification, see the following table:

| Standard | Frequency | Speed (Mbit/s) |
|----------|---------------------|---|
| 802.11b | 2,4 GHz | 1, 2, 5.5, 11 |
| 802.11g | 2,4 GHz | 1, 2, 5.5, 6, 9, 11, 12, 18, 24, 36, 48, 54 |
| 802.11n | 2,4 GHz, 5,4 GHz | 1, 2, 5.5, 6, 9, 11, 12, 18, 24, 36, 48, 54, 125 |

3.3.3 CONNECTION MANAGER CONTROLS

| KEY / ICON | DESCRIPTION |
|--|--|
|  | Displays the available Wi-Fi® Hotspots list. The list is automatically refreshed |
|  | Open lock:  Wi-Fi® Hotspot is open Closed lock:  Wi-Fi® Hotspot requires a password to access |
|  | Connected to Wi-Fi® Hotspot Not Connected to Wi-Fi® Hotspot Connecting to Wi-Fi® Hotspot |
|  | Signal strength for the selected Wi-Fi® Hotspot. If no Hotspots are selected, the Strength bar is not visible. A red bar indicates Low to Very Low signal; Green bar indicates Good, to Excellent signal |
|  | Tap  to switch Wi-Fi® ON Tap  to switch Wi-Fi® OFF |
|  | Tap on to refresh the available Hotspots list The Soft Key changes to  when automatic searching activity is in progress |
|  | Allows to connect to the Hotspot selected in the available Hotspots list |
|  | Tap to exit the Connection Manager |
|  | Tap to display the application version |
| KEYBOARD KEY | DESCRIPTION |
|  | Rotating allows scrolling through received Hotspots |

3.4 HOW TO CONNECT

1. When the Connection Manager is opened, it automatically searches for available Wi-Fi® Hotspots; to manually refresh the list tap on the  Soft Key.
2. Tap on the desired Wi-Fi® Hotspot from the list.
3. Tap on the  Soft Key.

4. If the Hotspot has been used before, tapping on the **CONNECT** Soft Key directly tries to connect to the selected Hotspot by using the Authentication Information (password) stored.
5. If the CPN Series Chart Plotter was not connected to the Hotspot before, and the Hotspot requires a Network (Password) Key, the configuration page will be displayed.

! If the Connection Manager has been connected to one or more of the detected Hotspots, it automatically tries to connect to the latest selected Hotspot. If the latest selected Hotspot is no longer available or if it has a weak signal, the Connection Manager tries to connect to the Hotspot with the strongest signal.

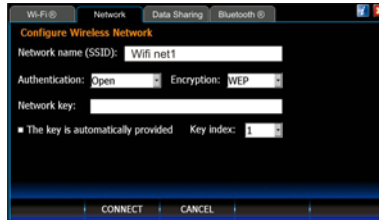

The Connection Manager will show the parameters of the selected Hotspot. To change an item tap on the area next to it and the touchscreen keyboard will appear for inserting text into the selected field. When finished, tap on to close the touchscreen keyboard.

W Not all Hotspots parameters are correctly detected. Sometimes it is required to manually insert authentication parameters.

6. When all the required fields are filled with the connection data, tap on the **CONNECT** Soft Key. If the connection is successfully completed, the Authentication Information is stored in order to be reused.

! The stored authentication information can be changed by double tapping on the desired Hotspot (the configuration page is shown).

3.4.1 AUTHENTICATION/ENCRYPTION PROTOCOLS

The supported Authentication Protocols are the following:

| Authentication | Encryption | Description |
|----------------|------------|--|
| WEP | OPEN | Wired Equivalent Privacy No authentication key required |
| WEP | SHARED | Wired Equivalent Privacy Requires a 64\128 bit network key to authenticate |
| WPA-PSK | TKIP | Wi-Fi Protected Access® Pre-Shared Key / Temporary Key Integrity Protocol Requires a 256 bit network key to authenticate |
| WPA-PSK | AES | Wi-Fi Protected Access® Pre-Shared Key / Advanced Encryption Standard Requires a 256 bit network key to authenticate |
| WPA2-PSK | TKIP | Wi-Fi Protected Access® II Pre-Shared Key / Temporary Key Integrity Protocol Requires a 256 bit network key to authenticate |
| WPA2-PSK | AES | Wi-Fi Protected Access® II Pre-Shared Key / Advanced Encryption Standard Requires a 256 bit network key to authenticate |

3.5 NETWORKING CONNECTION: C-MAP 4D CHARTS, NMEA & FISH FINDER DATA SHARING

The CPN Series Chart Plotter may be setup to share optional C-MAP 4D charts, NMEA & Fish Finder data (Depth, Temperature and Speed depending on transducer). Data sharing is accomplished between two (only) CPN Series Chart Plotters, one set up as Chart Plotter 1 (the one with the card inserted) and the other as Chart Plotter 2 (the other with no chart inserted). Please note that only the Chart Plotter 1 can have the Vector Chart Sharing¹ enabled. If both CPN Series Chart Plotters are configured with the Vector Chart Sharing option enabled, Vector Charts will not be shared.

The connection between CPN Series Chart Plotters is accomplished by connecting an optional Crossover Cable² between the Chart Plotter 1 and Chart Plotter 2 Ethernet connections on the rear panel. The maximum cable length is about 300ft or 100m.

! Only Vector Charts are shared, no Satellite or Raster Charts.

! It is possible to connect the two CPN Series Chart Plotters using a Hub or a Ethernet Switch.

3.5.1 CPN SERIES CHART PLOTTER SETUP

To share C-MAP 4D Charts (and NMEA & Fish Finder data) between two CPN Series Chart Plotters you will need to decide which Chart Plotter will have the C-MAP 4D CARD installed, this Chart Plotter is called Chart Plotter 1. The other Chart Plotter which will read and display information via Ethernet is called Chart Plotter 2. To setup the two CPN Series Chart Plotters please follow the procedure below:

1. Connect the Ethernet Crossover Cable between the two CPN Series Chart Plotters. Refer to the images below to identify the Ethernet port on your CPN Series Chart Plotter.

! Please see also the Par. 7.1.11 "Second CPN to share C-MAP 4D Charts, NMEA & FF data".

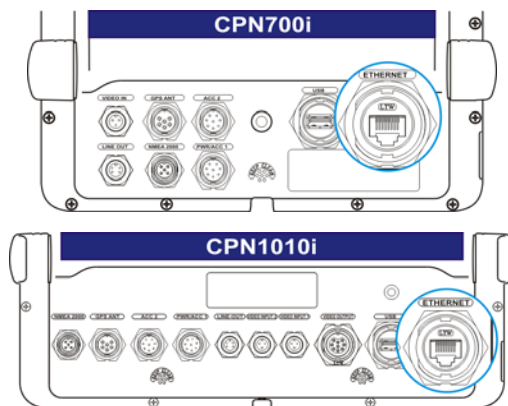

2. Press and hold the  PWR key to turn on both Chart Plotters.

Chart Plotter 1 Setup (with C-MAP 4D CARD inserted)

- When the Startup Screen page is shown, tap on the Connect Icon  (see A).



- The next display shown is the Connection Manager (see B), tap on the **Data Sharing** tab.
- Tap on **Vector Chart Sharing** to share Vector Charts inserted in the Chart Plotter 1 with the Chart Plotter 2 (see C):

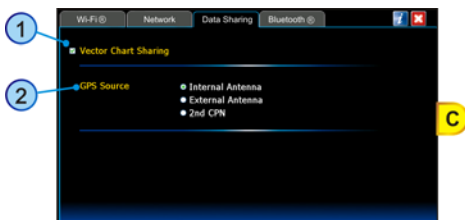

- After tapping **Vector Chart Sharing**, the following warning window appears:

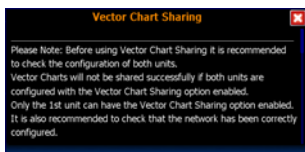

When touched up/down the bar scrolls the content of the warning window, to display the text in other languages. Tap on  to close the window.

- Tap on one of the GPS Source **GPS Source** options - among **Internal Antenna**, **External Antenna** or **2nd CPN** - to select the desired vessel position source.

- The proper GPS Source settings depend on the CPN Chart Plotter installation on the vessel.

- This setting can be changed anytime from the GPS Satus page in the Chart Plotter application. For more information see Setup Menu in the Par. 2.13.4 "Navigation pages".

- Tap on the **NETWORK** tab (see D) to configure the network settings.
- Tap on **Chart Plotter 1** to select this CPN Series Chart Plotter as Chart Plotter 1 (see E).

7. Tap on the **APPLY** Soft Key (see E).

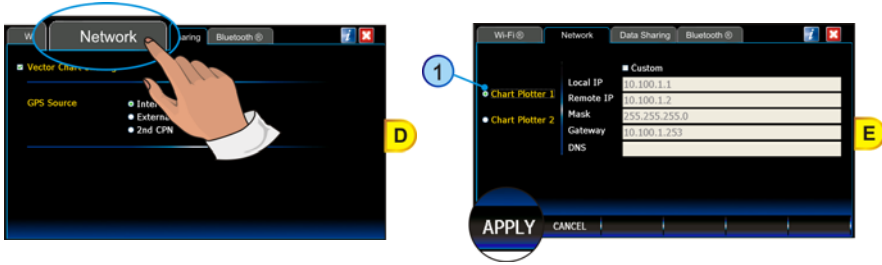

ⓘ If the Chart Plotter number is changed from Chart Plotter 1 to Chart Plotter 2 or vice versa, the following Warning popup window appears:

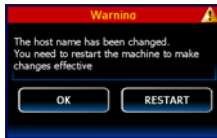

Tap on **RESTART** to apply the changes and restart the CPN Series Chart Plotter. Otherwise tap on **OK** to continue without restart, but the chart sharing functionality will not work until the Chart Plotter is restarted. In this case to restart the Chart Plotter, follow the procedure below:

1. Press and hold the **PWR** key until the display shows the Shut Down window:



2. Tap on **CONFIRM** to turn off the CPN Series Chart Plotter.

Chart Plotter 2 Setup (no chart inserted)

1. When the Startup Screen page is shown, tap on the Connect Icon  (see F).

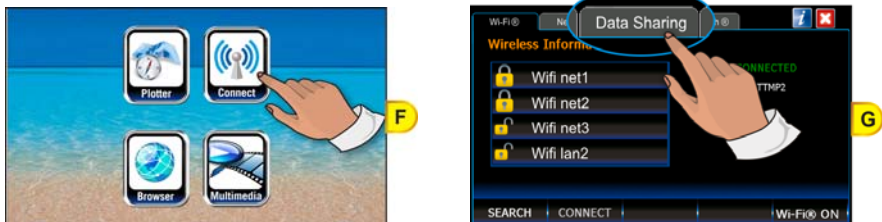

- The next display shown is the Connection Manager (see G), tap on the **Data Sharing** tab.
- Check that **1 Vector Chart Sharing** (see H) is disabled (otherwise if both CPN Series Chart Plotters are configured with the Vector Chart Sharing option enabled, vector charts will not be shared):

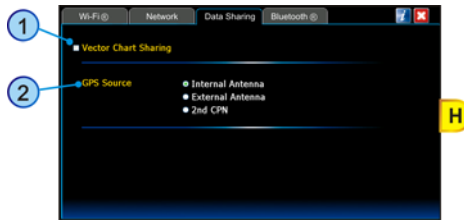

- Tap on one of the GPS Source **2** options - among **Internal Antenna**, **External Antenna** or **2nd CPN** - to select the desired vessel position source.

-
- !** The proper GPS Source settings depend on the CPN Chart Plotter installation on the vessel.
 - !** This setting can be changed any time from the GPS Status page in the Chart Plotter application. For more information see Setup Menu in the Par. 2.13.4 "Navigation pages".
-

- Tap on the **NETWORK** tab (see I) to configure the network settings:

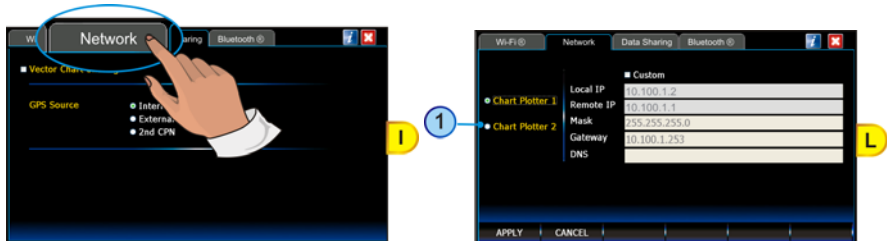

- Tap on **1 Chart Plotter 2** to select this CPN Series Chart Plotter as Chart Plotter 2 (see L).
- Tap on the **APPLY** Soft Key (see L).

-
- !** If the Chart Plotter number is changed from Chart Plotter 1 to Chart Plotter 2 or vice versa, the following Warning popup window appears:

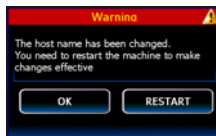

Tap on **RESTART** to apply the changes and restart the CPN Series Chart Plotter. Otherwise tap on **OK** to continue without restart, but the chart sharing functionality will not work until the Chart Plotter is restarted. In this case to restart the Chart Plotter, follow the procedure below:

- Press and hold the **PWR** key until the display shows the Shut Down window:



2. Tap on **CONFIRM** to turn off the CPN Series Chart Plotter.

8. Wait until the Startup Screen page appears on the CPN Series Chart Plotter's display.



9. Tap on the Plotter Icon and confirm the C-MAP 4D charts are shown on Chart

Plotter 2. Open the About page¹ on both CPN Series Chart Plotters and verify that the Chart Plotter 1, where the C-MAP 4D CARD is inserted, displays the Chart Code in field "Local SD Chart" and that the same Chart Code is displayed in the Chart Plotter 2 in the "Remote SD Chart" field.

 To display the About page:

1. Press the **MENU** key, tap on **Setup Menu**.
 2. Tap on the right arrow next to **ADVANCED** two times to display **ABOUT** and tap on it.
-

Custom Setup

 TO USE THIS FUNCTION IT IS NECESSARY TO HAVE PC NETWORK KNOWLEDGE.

The Custom Setup is reserved for future software updates where additional Ethernet devices (example Sounder etc.) may be connected. We **strongly** recommend using Chart Plotter 1 and Chart Plotter 2 setup discussed in the previous section to share Charts and NMEA & Fish Finder data.

3.6 PAIRING THE CPN MULTIMEDIA CHART PLOTTERS WITH *Bluetooth*[®] WIRELESS TECHNOLOGY

It is possible to pair the CPN700i or CPN1010i Multimedia Chart Plotters with a *Bluetooth*[®] wireless mouse and/or keyboard following the procedures below.

During the pairing process the *Bluetooth*[®] device must be in Discovery Mode (it might be named slightly differently depending on the device manufacturer). Please refer to the documentation for the *Bluetooth*[®] device to find specific instructions on device discovery.

 In some applications the *Bluetooth*[®] keyboard might not be fully supported.

3.6.1 ACTIVATION OF Bluetooth® DEVICE

1. When the Startup Screen page is shown, tap on the Connect Icon (see A).

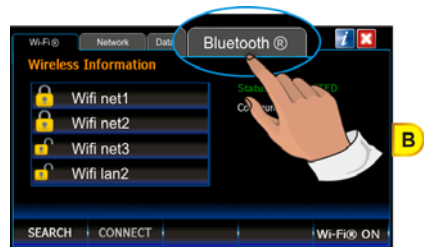

2. The next display shown is the Connection Manager (see B), tap on the tab called *Bluetooth*®.
3. The Soft Key displayed at the bottom right corner of the screen (see C) switches the *Bluetooth*® wireless device OFF or ON. The Soft Key indicates the status of the *Bluetooth*® wireless device after pressing the Soft Key:
 - if **BT OFF** is displayed, pressing the Soft Key will turn the *Bluetooth*® wireless device OFF.
 - if **BT ON** is displayed, pressing the Soft Key will turn the *Bluetooth*® wireless device ON.

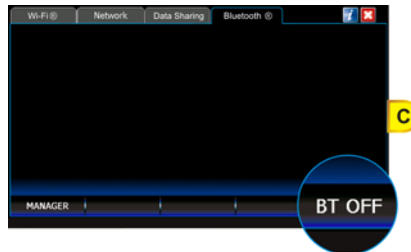

3.6.2 PAIRING Bluetooth® DEVICE

To pair a wireless mouse and/or keyboard follow the procedure below:

1. When the *Bluetooth*® wireless device is on (**BT OFF** is shown), tap on the **MANAGER** Soft Key to open the Manager window for *Bluetooth*® (see D):

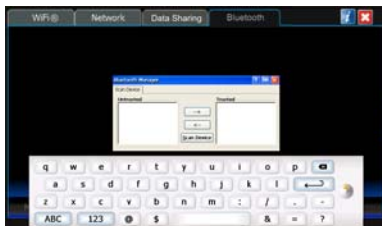

2. Tap on **Scan Device** button shown on the bottom of the Manager window for *Bluetooth®* (see E).

ⓘ Depending on the screen size, the Manager window for *Bluetooth®* might be partially covered by the touchscreen keyboard. Please drag the Manager window for *Bluetooth®* up until **Scan Device** button is visible.

All available *Bluetooth®* wireless devices in your proximity will appear in the Untrusted list (see E: left side of the Manager window for *Bluetooth®*).

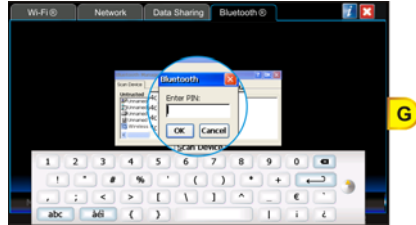
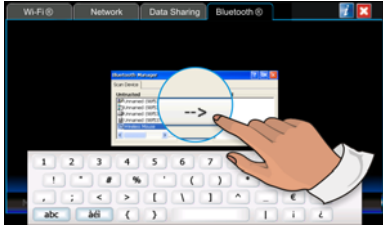

While scanning *Bluetooth®* wireless devices, the **Scan Device** button changes to **Stop** button, allowing you to stop the searching process.

The **Stop** button changes to **Scan Device** button again when the scanning process is completed.

3. In the Untrusted list tap on your device (mouse or keyboard). Then tap on **-->** button (see F) to pair your device.

A message appears, prompting you to authenticate your device.

4. To authenticate your device, tap on **YES**. When prompted, by using the touchscreen keyboard enter the PIN number (please refer to the documentation for the *Bluetooth®* device to find the default code) and tap on **OK** (see G).

PAY ATTENTION:

If your device is a *Bluetooth®* wireless keyboard, as soon as **OK has been pressed, by using your *Bluetooth®* wireless keyboard you must type the same PIN number and then press the ENTER key.**

ⓘ Depending on the screen size, the Authentication window might be partially covered by the touchscreen keyboard. Please drag the Authentication window up until **OK** is visible.

If the Authentication process is successfully completed, the device will be moved in the Trusted list on the right (see H):



5. Double tap on your device in the Trusted list to display the menu (see I) and tap on **Active**. A red check mark appears on the device icon in the Trusted list. The *Bluetooth®* wireless device is now paired and ready to use.

3.6.3 UNPAIRING Bluetooth® DEVICE

To unpair the CPN700i or CPN1010i Multimedia Chart Plotters from a *Bluetooth*® wireless mouse and/or keyboard with which it was previously paired, follow the procedure below:

1. Double tap on your device in the Trusted list to display the menu (see *L*) and tap on **Delete** to remove the device.



4 - INTERNET BROWSER



4.1 GETTING STARTED

The Getting Started section will take you through frequently used operations using the Browser. The Browser is a software application which allows you to navigate the web and display Internet pages. Browser supports the following 16 languages:

- English
- German
- Swedish
- Danish
- Finnish
- Japanese
- Italian
- Spanish
- Portuguese
- Dutch
- Russian
- French
- Norwegian
- Chinese (Traditional)
- Greek
- Chinese (Simplified)

The CPN Series Chart Plotter uses Zetakey™ Browser. Some websites may be not fully compatible with Zetakey™ Browser.

4.2 STARTING THE INTERNET BROWSER

To activate the Browser as a standalone application, follow the procedure below:

1 From the Chart Plotter Mode

1. Press and hold the  PWR key until the display shows the window below:

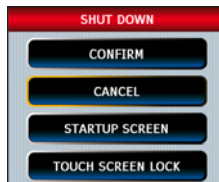

2. Tap on **STARTUP SCREEN** to display the Startup Screen page.

2 From the Startup Screen page

1. Turn on the CPN Series Chart Plotter.
2. When the Startup Screen page is shown, tap on the Browser Icon  (see A).



3 Internet Navigation from the Chart Plotter

While in Chart Plotter Mode press the **I** Intelligent key. Tap on Browser Icon  to open the Browser application.

W The Chart Plotter Mode will be closed.





! If no **Wi-Fi**® network connection is available the Connection Manager page is automatically opened. When a connection is established and the Connection Manager is closed, the Browser is automatically launched.

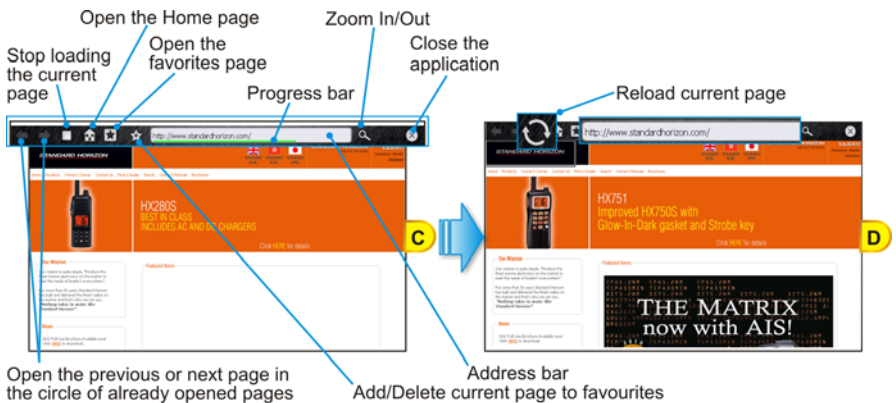



















4.3 BROWSER OVERVIEW







The Browser Home page is displayed when the Browser is launched (see C): when loading

is completed the green progress bar disappears and the Stop icon  is replaced by the Reload icon  (see D).

4.3.1 INTERNET BROWSER CONTROLS

| KEY / ICON | DESCRIPTION |
|--|---|
|   |  Opens the previous page  Opens the next page <i>If no pages have been opened so far, they are not active (disabled and grayed out)</i> |
|   |  Stops loading page  Reloads the current page |
|  | Opens the Home page (<i>www.standardhorizon.com</i>) |
|  | Opens the Bookmarks (favorites) page |
|   |  Adds the current page to favorites  Deletes the current page from the favorites |
|  | Address and Progress bar The Progress bar (<i>green</i>) appears to show the loading progress and disappears when loading is completed. Tap on the address bar to enter the desired URL (<i>Web address</i>) |
|  | Opens the zoom menu:  Larger increases the zoom level  Normal resets the zoom level (default)  Smaller decreases the zoom level |
|  | Exits the Internet Browser |



| KEYBOARD KEY | DESCRIPTION |
|---|--|
|  | Pressing on  increases the zoom level |
|  | Pressing on  decreases the zoom level |
|  | Selects the available links |

4.4 HOW TO NAVIGATE

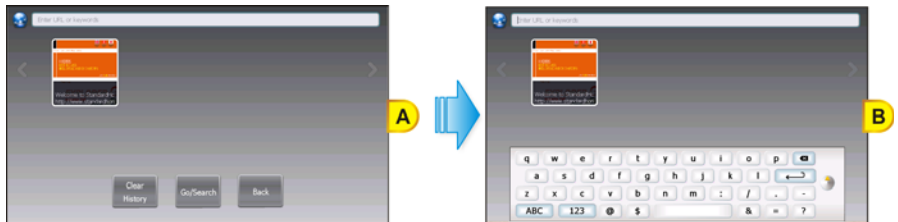
At this point you can start Internet navigation by typing the desired URL (website address) or performing a Search operation. Tapping on the address line opens the following page (see A):



From this page (see A) it is possible to tap on the address line to display the Touchscreen Keyboard (see B). The Touchscreen Keyboard can be used to enter the desired URL or to insert the search terms. When finished tap on  (or on the **GO/SEARCH** Soft Key) to perform the operation, the keyboard disappears.

 The **GO/SEARCH** Soft Key might be hidden from view because it is under the Touchscreen Keyboard: tapping on  and  places the keyboard on the bottom and top side of the screen respectively.

To return to the previous page tap on on the **BACK** Soft Key at the bottom of the page. While browsing sometimes it is needed to insert text data or passwords. Tap on the desired field to display the Touchscreen Keyboard:



It is possible



- to open links contained in the page by simply tapping on them.
- to scroll the page press a finger on the screen and move the finger in any direction.

4.5 THE FAVORITES PAGE

When navigating, you may find a page you wish to recall afterward. The Internet Browser has a list of pre-defined favorite addresses (Bookmarks), but it allows adding and removing pages to and from the favorites list.

To add the currently opened page to the favorites list, tap on the Add-Favorite icon :



When a website is present in the favorites list, the Add-Favorite icon  turns to Remove-Favorite icon  allowing to remove that page from the list.

Tap on the Favorites icon  (see A), to display the favorites list (see B):

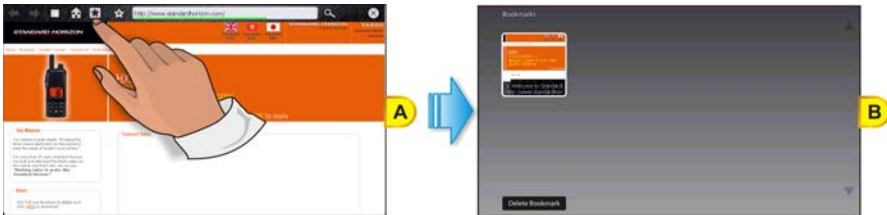

You can now:

- access the desired favorite page by tapping on the relative preview;
- delete one or more pages from the list of favorites by tapping on the **DELETE BOOKMARK** Soft Key. A cross icon appears in the upper right corner of each preview: tap on the cross to delete the selected page. Tap on the **CANCEL** Soft Key to close the favorites list.

4.6 THE HISTORY LIST

All the visited pages are automatically saved in the History list. Tap on the address bar to open the History page.



- recall a previously opened website by tapping on the relative preview;
- clear the history by tapping on the **CLEAR HISTORY** Soft Key. No confirmation will be asked;
- return to the previous page by tapping on the **BACK** Soft Key.

4.7 PLAYING MEDIA CONTENTS

The Zetakey™ Browser is able to reproduce multimedia streamings. When navigating on a website which provides supported media contents, a PLAY icon will be displayed over them: tap on the PLAY icon to reproduce the content.

-
- ! Media contents present in web pages will be played in Media Player. After closing Media Player the web page containing the content will be displayed again.
-

4.8 DOWNLOADING PDF FILES

It is possible to read PDF files from a website. To open a PDF file contained in a web page simply tap on its link. The PDF file will be downloaded and displayed (see Par. 5.5 "Displaying PDF files").

-
- ! PDF files will be displayed in a dedicated application. After closing the application the web page containing the link to the PDF will be displayed again.
-

5 - MEDIA PLAYER

5.1 GETTING STARTED

The Getting Started section will take you through frequently used operations using the Media Player functionality. It is possible to open the Media Player functionality in two modes:

- as a standalone application (accessed from Startup Screen)
- as a background application, meaning it can be directly accessed while in Chart Plotter Mode. Only audio files may be played, no video or images files can be viewed while in Chart Plotter Mode.

The Media Player is able to display and reproduce the following formats:

| Video: | Audio: | Image: | Document: |
|---------------|---------------|----------------------|------------------|
| MPEG-1 | MP3 | BMP Decoder | PDF |
| MPEG-4 | Wave | GIF Decoder | |
| H.264 | AIFF | JPG Decoder (VPU+SW) | |
| DivX | FLAC | PNG Decoder | |
| Xvid | VMA8 | | |
| QuickTime | VMA9 | | |
| MOV | AU | | |

5.2 STARTING MEDIA PLAYER

To activate the Media Player functionality as a standalone (not using the Chart Plotter) application, follow the procedure below.

1 From the Chart Plotter Mode

1. Press and hold the  PWR key until the display shows the window below:

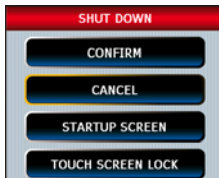

2. Tap on **STARTUP SCREEN** to display the Startup Screen page.

2 From the Startup Screen page

1. Turn on the CPN Series Chart Plotter.
2. When the Startup Screen page is shown, tap on the Media Player Icon  (see A).



To activate the Media Player functionality while using the Chart Plotter application, follow the procedure below.

3 Simultaneous Multimedia Music and Chart Plotter

While in Chart Plotter Mode press the  Intelligent key. Tap on Media Player Icon to open the player application.



-  Press the  Intelligent key to toggle between the Media Player and Chart Plotter Modes.

5.3 OVERVIEW

If you have saved audio, video, image or PDF files on a USB Thumb Drive (see Par. 5.6 “Saving Files on a USB Thumb Drive”) or an SD CARD, now you are able to display and reproduce these files on the CPN Series Chart Plotter.

1. Connect the media device to a CPN Series Chart Plotter.
2. Start the Media Player from the Startup Screen page (see A) or by pressing the  Intelligent key on the front of the CPN Series Chart Plotter when in Chart Plotter Mode.



3. Tap on the drop down list to select the media device and display its content (see B):



4. Tap on the folder to be viewed (example Audio), see C:



5. Tap on the multimedia file to play (see D):























The selected multimedia file will automatically begin to play.

5.4 MEDIA PLAYER CONTROLS



 While playing files, you can touch the Progress Bar to move forward or backward.

| KEY | DESCRIPTION |
|--|--|
|  Folder | Opens the last selection on the USB Flash Drive or the SD CARD. |
|  Reverse | Selects the previous (video, image or audio) media file in the folder |
|  Play / Pause | Switches between two functions:  Tap on to start playing the selected video, image or music file or to resume after pausing  Tap on to pause a video, image or music file |
|  Stop | Stops playing the selected video, image or audio file |
|  Forward | Selects the next (video, image or music) media file in the folder |
|  Repeat control | Switches among three functions:  Default setting, plays all video, images or audio files and then repeats  Play one video, image or audio file, then stops  Repeats a video, image or audio file (until stopped) |
|  Front Speaker | Switches between two functions:  Front speaker On  Front speaker Off The speaker selection setting is saved and used at the next startup |
|  Mute / Un-Mute | Switches between two functions:  Shown when audio is muted. Tap on to un-mute the speakers  Shown when audio is playing. Tap on to mute the speakers |
|  Volume Down | Tap on to decrease the volume on step Tap on and hold to decrease the volume quickly |
|  Volume Up | Tap on to increase the volume on step Tap on and hold to increase the volume quickly |
|  Exit | Tap on to exit the Multimedia player |

5.5 DISPLAYING PDF FILES

A PDF file is displayed as shown below (see A):



Viewing PDF files:

- scroll the page up and down:
 - a. Press and hold the finger on the page and then drag it from up to down: page goes up. Press and hold the finger on the page and then drag it from down to up: page goes down.
 - b. If scroll bar is shown, tap above/below the scroll bar to scroll the page up/down.
 - c. With mouse device connected to CPN Series Chart Plotter, click and drag up/down to scroll the page up/down.
 - d. Move the ShuttlePoint knob up and down to scroll the page up/down. When the bottom/top of the page is reached, the next/previous page is shown.

Depending on zoom level it is possible to move the page to left or right too.

- zoom in/out on the page. Pressing the or key allows to increase/decrease the zoom level.
- obtain information about the application by tapping on the icon.
- return to the previous/next page by tapping on the icon.
After pressing the icon, the new page is displayed from the beginning.
- go to the desired page by inserting the page number.
After tapping on Goto page (see A), a touchscreen keyboard appears (see Par. 1.2.1 "Touchscreen"). Insert the desired number (see B); when finished tap on ; the keyboard disappears. The new page is displayed from the beginning (see C).

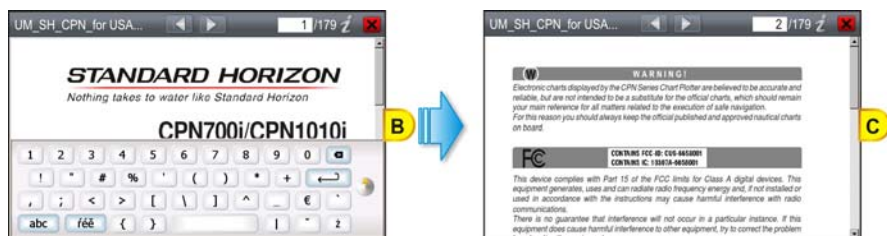

- close the PDF file by tapping on the icon, and return to Media Player or Browser depending on where the PDF file has been launched from.

5.6 SAVING FILES ON A USB THUMB DRIVE

You can save audio, video, image or PDF files on a USB Thumb Drive, and then read and play these files on the CPN Series Chart Plotter.

To save files on a USB Thumb Drive please follow the procedure in the example below which refers to a PC with Windows® XP Operating System. Other versions of Windows® may be slightly different.

1. Connect a USB Thumb Drive to a PC on which you have stored videos, images, music or PDF files.
2. If the AutoPlay functionality is enabled, the following window will be displayed:

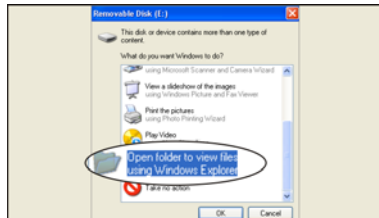

In this case double click on **OPEN FOLDER TO VIEW FILES USING WINDOW EXPLORER**.

Otherwise open **MY COMPUTER** and double click on the USB device (e.g. USB Disk, Removable Disk ...).

3. The content of the device will be displayed:

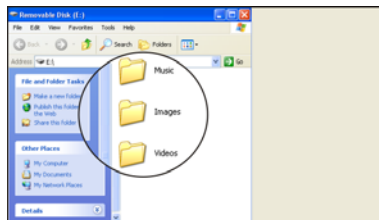

Create directories to save files to, example Music, Images, Videos or name of Artist etc. Creating these folders will make it easier when using the Media Player to view images, play music or videos.

4. Save files into the proper folders on the USB Thumb Drive.
5. Safely eject the USB Thumb Drive from the PC. Now you have the desired audio, video, image or PDF files stored on the USB Thumb Drive, ready to use (see the Par. 5.3 "Overview").

 If you want to save files on SD CARD, a SD CARD Reader is needed. The saving files procedure is the same.

6 - INSTALLATION

6.1 MOUNTING THE CPN SERIES CHART PLOTTER

The CPN Series Chart Plotters are supplied with a swivel mounting bracket which allows them to be dash mounted. When flush mounting, the optional GPS Antenna may be needed to receive GPS satellite signals. Refer to the images below for bracket installation:

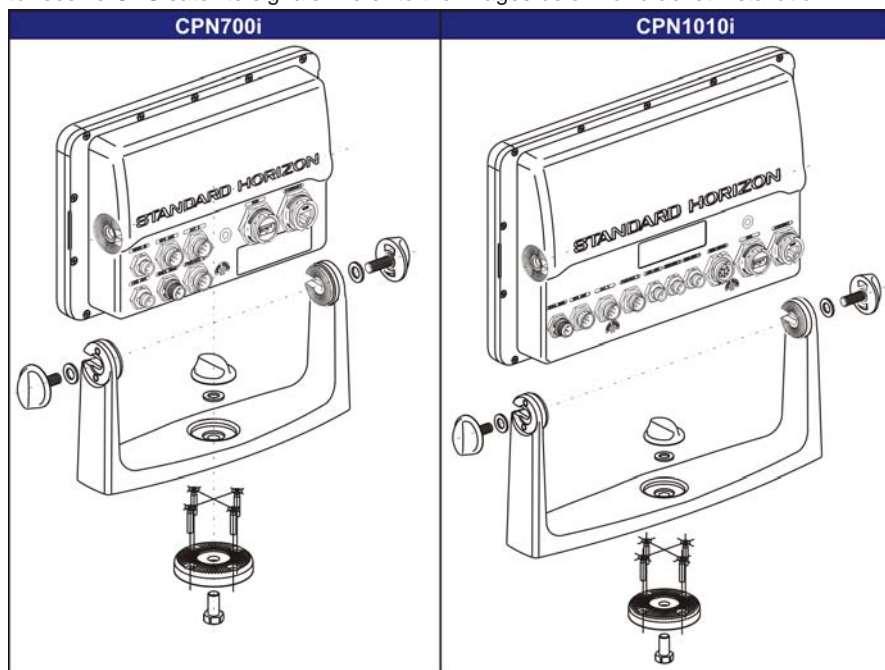

ⓘ When choosing a location to bracket mount a CPN Series Chart Plotter it is advisable to temporarily connect the CPN Series Chart Plotter to power, enter Chart Plotter Mode and check the signal strengths by touching on the Navigation icon, and touching the GPS Status icon. If the GPS satellite signals are low or the CPN Series Chart Plotter cannot receive a fix, an optional GPS Antenna may be purchased and installed. Refer to Introduction section in the Optional Accessories paragraph.

ⓘ To swivel the bracket, loosen the center mounting knob and turn the CPN Series Chart Plotter to the left or the right. When finished re-tighten the mounting knob.

6.1.1 BRACKET MOUNTING

Before installing, ensure the area the bracket is mounted to is strong enough to support the

weight of the CPN Series Chart Plotter, especially while underway. After the location is found, attach the mounting base to the area using the supplied hardware (see the previous picture).

6.1.2 FLUSH MOUNTING THE CPN SERIES CHART PLOTTER

The CPN Series Chart Plotters are supplied with a flush mount cutout template and a flush mount kit. Refer to the images below as a guide to installing.

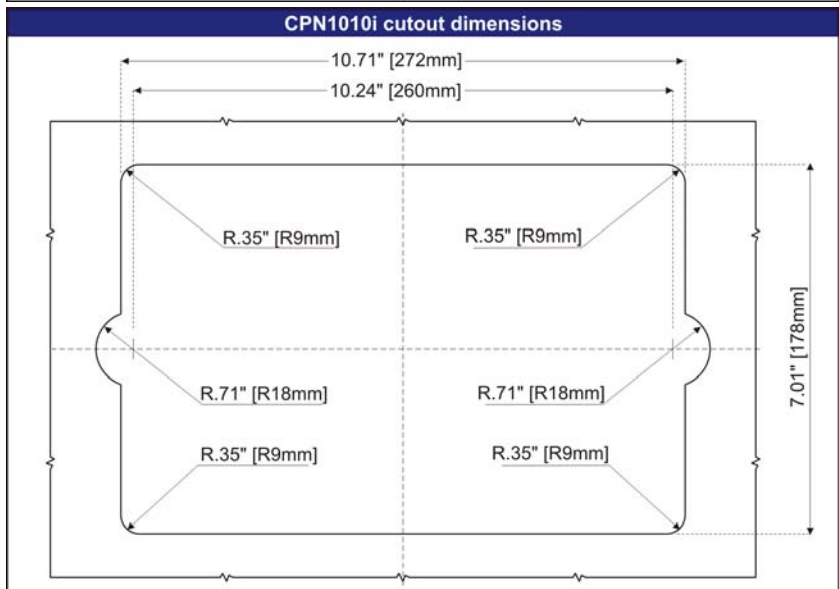
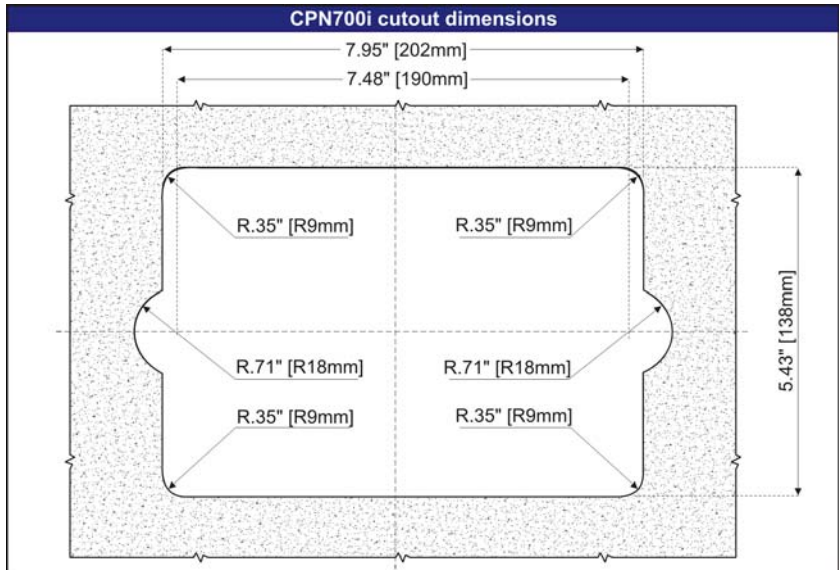

! Before drilling holes make sure there is enough room to mount the CPN Series Chart Plotter and there are no obstructions.

1. After a location is found, peel the template label from the backing and apply the label to the mounting area.
2. Drill a hole in one area of the cutout area that will allow the blade of a jig saw to be inserted. Insert and cut out the area on the panel using the jig saw.
3. Next drill the four holes required to insert the CPN Series Chart Plotter with the mounting studs.
4. Install pieces into mounting holes on the side of the CPN Series Chart Plotter before inserting plotter into mounting hole.

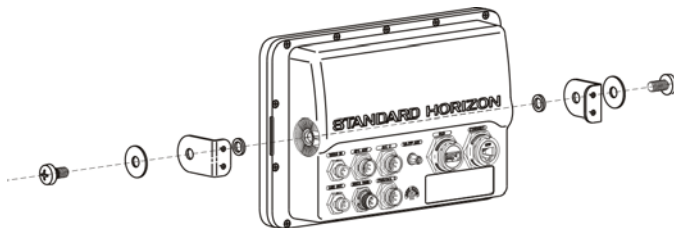

5. Slide the CPN Series Chart Plotter into the dash of mounting hole.

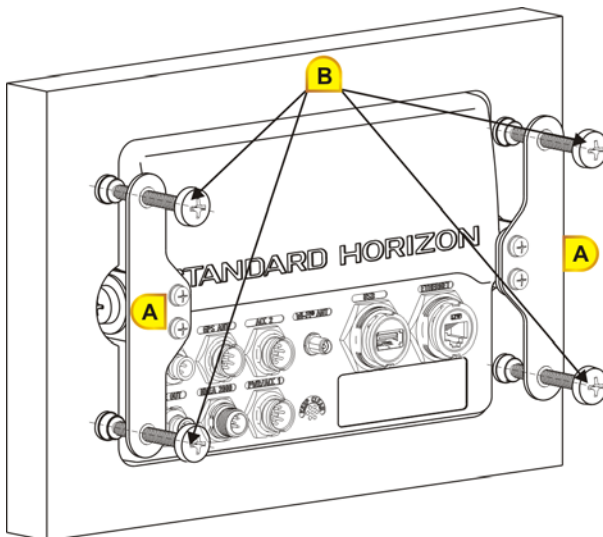

6. Install the left and right brackets using the four lock washers and 4 screws (see A).
7. Tighten the four tension screws to hold the CPN Series Chart Plotter into the panel (see B).

6.2 MOUNTING THE OPTIONAL EXTERNAL GPS ANTENNA

An external WAAS GPS Antenna is available when the CPN Series Chart Plotter is flush mounted or mounted in an area where satellite reception is not possible with the internal antenna. This antenna is designed to be mounted on a base, installed on an extension or flush mounted.

Choose a location for the antenna that has a clear view of the sky and is not located within 3ft of a Radar or other transmitting antennas. Ensure there are no major obstructions or fixtures in the immediate proximity to the antenna. The antenna relies on direct "line of sight" satellite reception. If you are unsure of the chosen location, temporarily mount the antenna in the desired location to verify correct operation. If mounted close to Radar, after the CPN Series Chart Plotter has a fix, turn on the Radar to ensure the CPN Series Chart Plotter holds the fix (use the GPS Status page, see sub-paragraph "GPS Status page" in the Par. 2.13.4).

The thread used on the antenna is an industry standard (1inch 14TPI) used on a wide range of mounting brackets.

! The antenna cable can be cut and spliced to ease installation. Care must be taken when reconnecting the antenna cable to protect from water and corrosion.

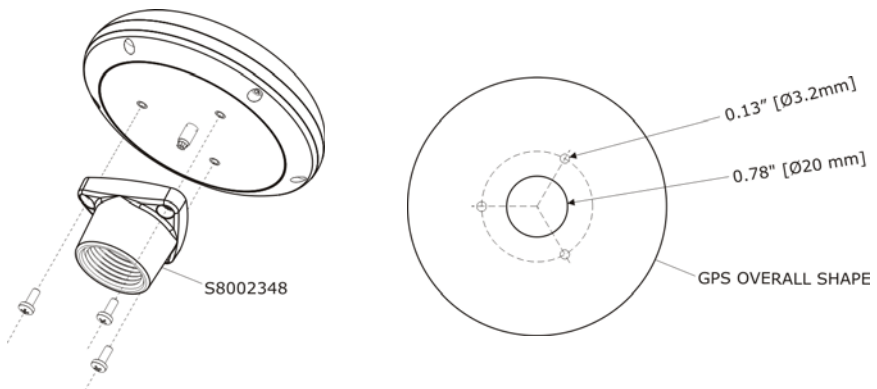

6.2.1 FLUSH MOUNTING THE ANTENNA

! Before drilling holes, it is recommended the antenna be positioned where the location is planned, cable connected to the CPN Series Chart Plotter and power turned on to ensure a GPS Fix is received.

1. To ease installation a flush mounting template for the antenna has been included.
2. Apply the mounting template sticker to the area that was verified for GPS reception.
3. Then, drill out the 0.78" (20mm) and 0.13" (3.2mm) holes, and remove the template.
4. Insert the cable into the 0.78" (20mm) hole and route to the CPN Series Chart Plotter.
5. Apply a small amount of RTV to the underside of the antenna and place onto mounting surface. Allow time for the antenna to adhere to the mounting surface.

7 - CONNECTIONS

7.1 OVERVIEW

The CPN Series Chart Plotter has connectors that allow it to be connected to:

- Battery Connections
- NMEA-0183 Devices (VHFs, AIS Receiver, Digital Instruments and Autopilots)
- Optional FF525 BLACK BOX FISH FINDER
- Optional Video Camera
- Optional monitor with VGA input (CPN1010i)
- Optional GPS Antenna
- Optional Audio Amplifier and speakers
- Optional USB memory stick
- Optional External Alarm
- Second CPN Series Chart Plotter to share C-MAP 4D charts
- NMEA-2000 Devices

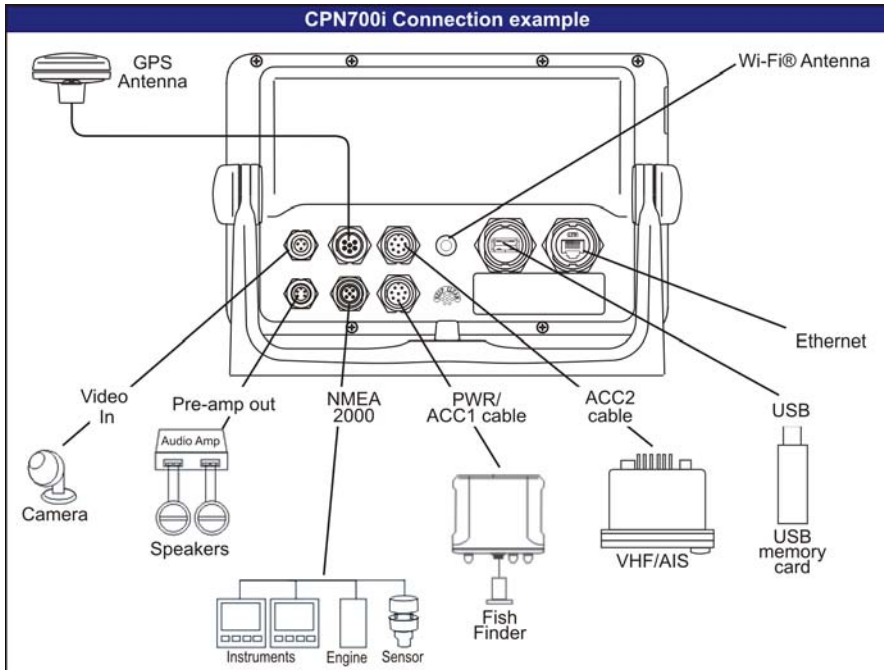

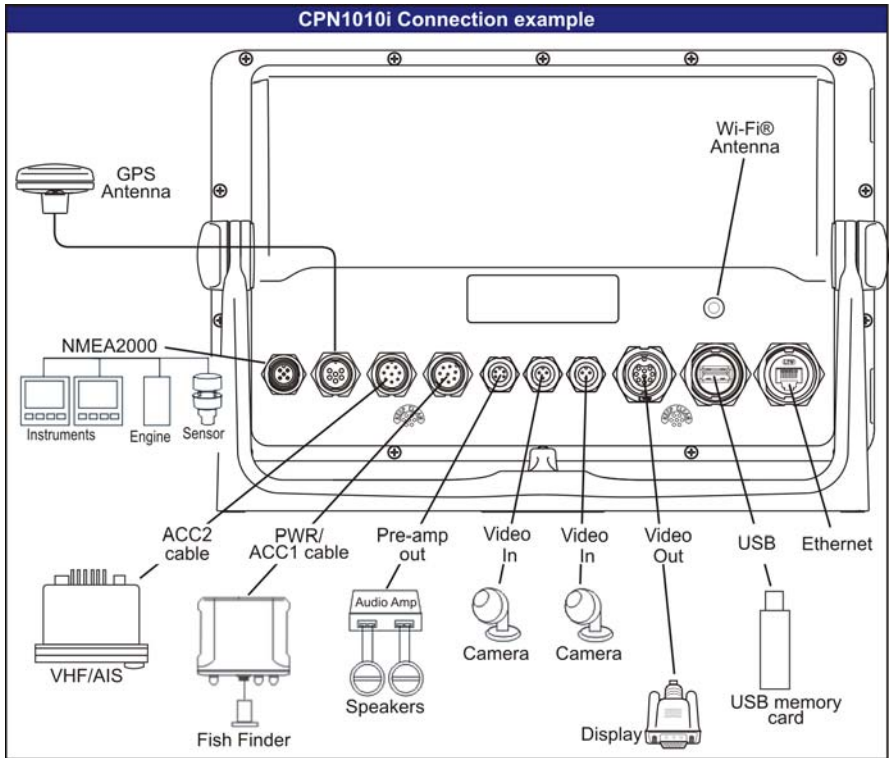

7.1.1 BATTERY CONNECTIONS

1. The CPN Series Chart Plotter is supplied with a fuse and holder. This fuse should be installed into the Black wire to protect the NMEA-0183 Output/Input circuits from becoming damaged, however it can also be installed in the red wire.
2. Two accessory cables (exactly the same cable) are supplied with the CPN Series Chart Plotter.
3. Connect one of the accessory cables to the PWR/ACC1 connector on the rear panel. The other accessory cable is used to connect to ACC2 connector.
4. This cable has many wires, however only the Red and Black wires are used to connect to a switched battery supply. Refer to the following images. For additional connections refer to Par. 7.1.2 "NMEA-0183 Connections".

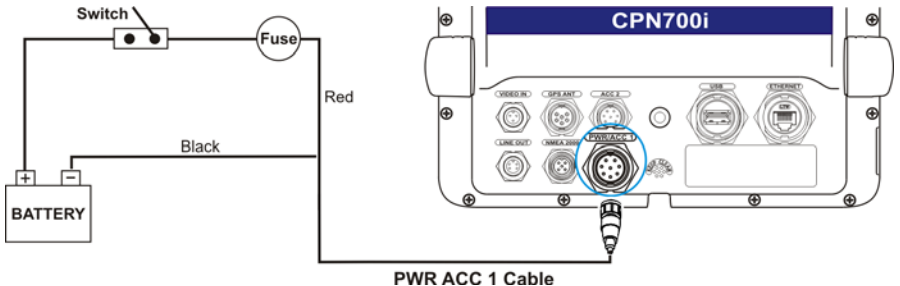

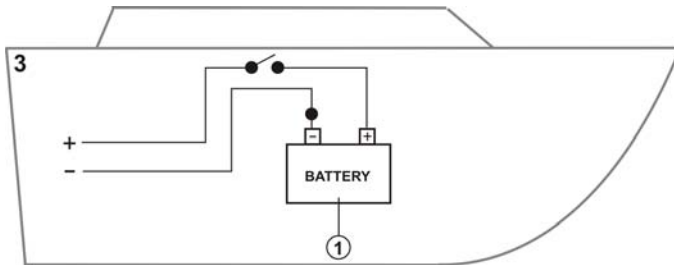

4. Other Electronic Devices DC isolated from the earth (Boat Ground)

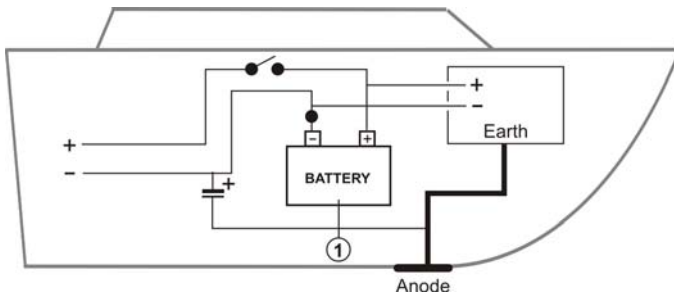

Step2:

1. Please connect the Black wire of the Power Cable at its termination to the Boat Ground.

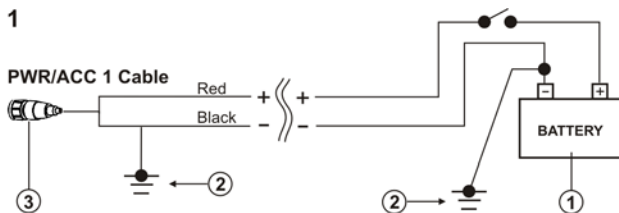

2. Please connect the Red wire of the Power Cable at its termination to the Boat Ground.

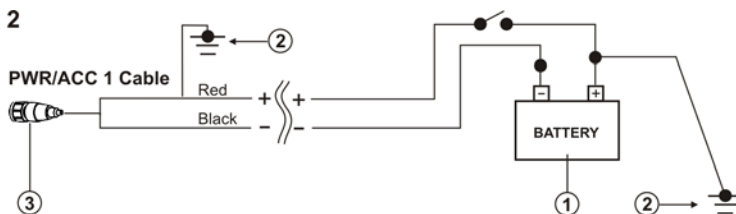

3. Please connect the Black wire of the Power Cable at its termination to the Boat Ground. If not available, it could be the engine chassis.

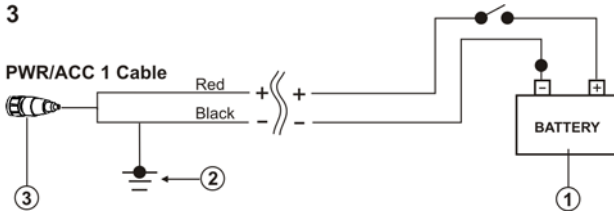

4. Please connect the Red and Black wires of the Power Cable respectively to the positive and negative poles of the Boat Battery.

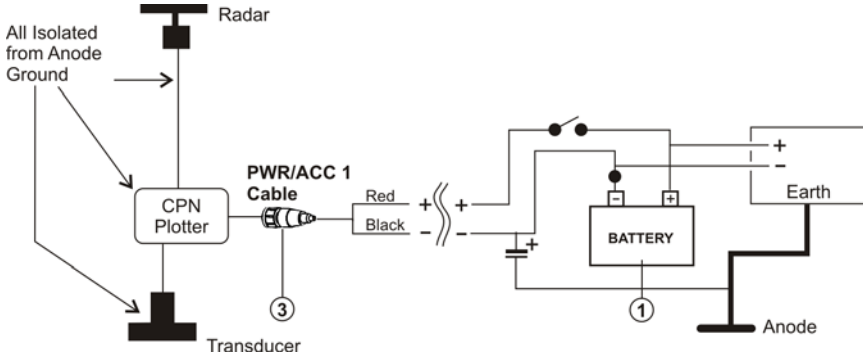

! In the pictures ① indicates Boat Battery, ② Boat Ground and ③ Power Cable.

7.1.2 NMEA-0183 CONNECTIONS

! The CPN Series Chart Plotter is supplied with two accessory cables. These two cables may be connected to PWR/ACC1 or ACC2 connections.

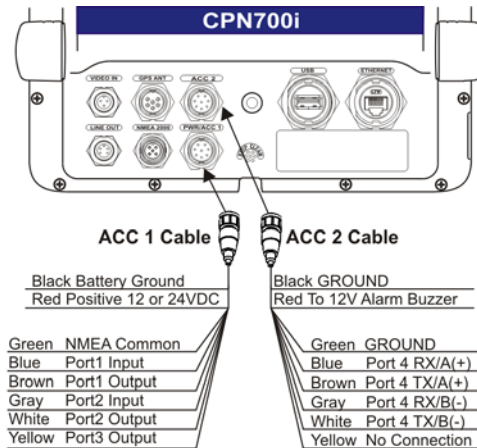

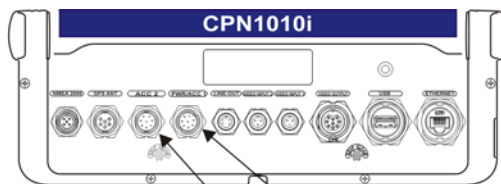

ACC 2 Cable

ACC 1 Cable

Black GROUND
Red To 12V Alarm Buzzer

Black Battery Ground
Red Positive 12 or 24VDC

Green GROUND
Blue Port 4 RX/A(+)
Brown Port 4 TX/A(+)
Gray Port 4 RX/B(-)
White Port 4 TX/B(-)
Yellow No Connection

Green NMEA Common
Blue Port1 Input
Brown Port1 Output
Gray Port2 Input
White Port2 Output
Yellow Port3 Output

RS422 connections

RS232 connections

| PWR/ACC 1 Cable | | | | |
|-----------------|------------------|----------------------------------|--|---|
| Pin | Cable Wire Color | Description | Connection Example | Additional Comments |
| 1 | Black | Battery Ground | Connect to Battery Ground | |
| 2 | Red | Battery Positive | Connect to Battery Positive | Voltage range 12-24VDC |
| 3 | Green | Common (ground) for NMEA devices | Connect to signal common | |
| 4 | Blue | Port 1 Input (*) | Connect to Output of NMEA device | Default is NMEA0183 |
| 5 | Brown | Port 1 Output (*) | Connect to Input of NMEA device | Default is NMEA0183 with GSA, GSV, GGA, GLL, RMC, XTE, DBT, DPT, MTW, VHW sentences |
| 6 | Gray | Port 2 Input (*) | Connect to FF520 or FF525 | Default is Fish Finder |
| 7 | White | Port 2 Output (*) | Connect to FF520 or FF525 | Default is Fish Finder |
| 8 | Yellow | Port 3 Output (*) | Connect to Input of NMEA device (*), shared with GPS | Default is NMEA0183 with APA, APB, BOD, GGA, GLL, RMC, XTE sentences |

(*) RS232 not opto-isolated

| ACC 2 Cable | | | |
|-------------|------------------|-----------------------------|--|
| Pin | Cable Wire Color | Description | Connection Example |
| 1 | Black | GROUND | |
| 2 | Red | ALARM | When any alarm Condition occurs the red wire is switched from High Impedance to Ground. When purchasing the optional buzzer, choose a 12Vdc type with a Max current 400mA or less. |
| 3 | Green | GROUND | |
| 4 | Blue | Port 4 Input RX /A (+) (*) | Connect to TX /A (+) Output of NMEA device |
| 5 | Brown | Port 4 Output TX /A (+) (*) | Connect to RX /A (+) Input of NMEA device |
| 6 | Gray | Port 4 Input RX /B (-) (*) | Connect to TX /B (-) Output of NMEA device |
| 7 | White | Port 4 Output TX /B (-) (*) | Connect to RX /B (-) Input of NMEA device |
| 8 | Yellow | NC | NC |

(*)RS422, NMEA0183 opto-isolated, 38400baud max speed

PWR/ACC1 Connections

PWR/ACC1 contains 3 NMEA RS232 type outputs and 2 NMEA RS232 type inputs (RS232 has one common NMEA Signal ground).

ACC2 Connections

ACC2 contains 1 NMEA RS422 (A and B signal wires) type Port.



PORT Input selections

Each Port may be configured to be able to connect to specific devices:

- NMEA-0183 4800 Baud
- GPS Auto¹ - External GPS devices of unknown or different than 4800 Baud. The system will automatically detect connected GPS's Baud Rate and will allow correct communication with this device.
- Fish Finder¹ - select when optional FF525 is connected (Port2 default set to Fish Finder).
- AIS 38400 - select when AIS Receiver or transponder is connected to an input
- Disabled - disables the Port

 Not available for ACC2.



To change a selection, follow the procedure below:

1. Press the  key, tap on **Setup Menu**.
2. Tap on **ADVANCED**.
3. Tap on **IN/OUT Connections**.
4. Tap on the Port Input to be changed, than tap on the desired input.
5. Press the  key to exit the menu.

PORT Output sentences

When NMEA-0183 4800 is selected the CPN Series Chart Plotter allows selection of the NMEA-0183 Output sentences. The NMEA-0183 sentences read from external devices are listed in the Par. 8.1 "CPN700i" and Par. 8.2 "CPN1010i".

To enable or disable output sentences follow the procedure below:

1. Press the  key, tap on **Setup Menu**.
2. Tap on **ADVANCED**.
3. Tap on **IN/OUT Connections**.
4. Tap on the Port Output Sentences.
5. Tap on the desired sentence to enable or disable.
6. Press the  key to exit the menu.

CPN Series Chart Plotter to NMEA-0183 connection examples

VHF Radio Connection Example - RS232 and RS422 Connections

The following image shows how a VHF radio with RS232 Connections (NMEA Common/Ground) or RS422 type (A&B Signal wires) may be connected.

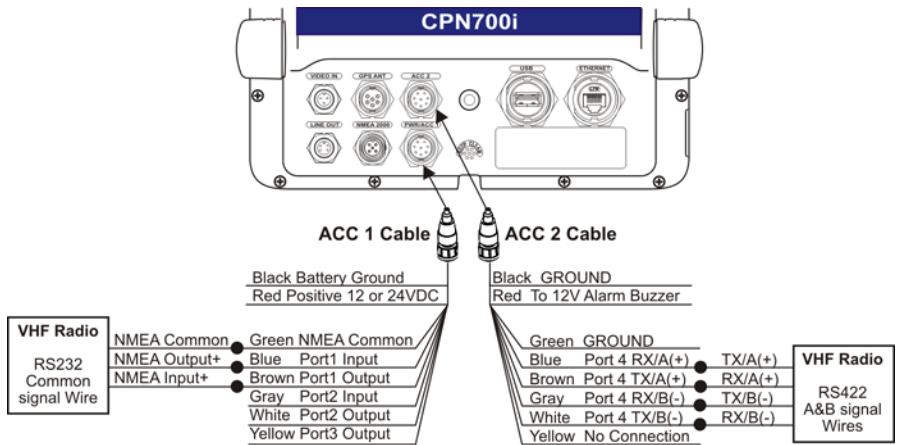

2 VHF/AIS Radio (GX2100 or GX2150) Connections (RS232)

CPN Series
*Port 1 set to NMEA 4800
**Port 2 set to AIS 38400

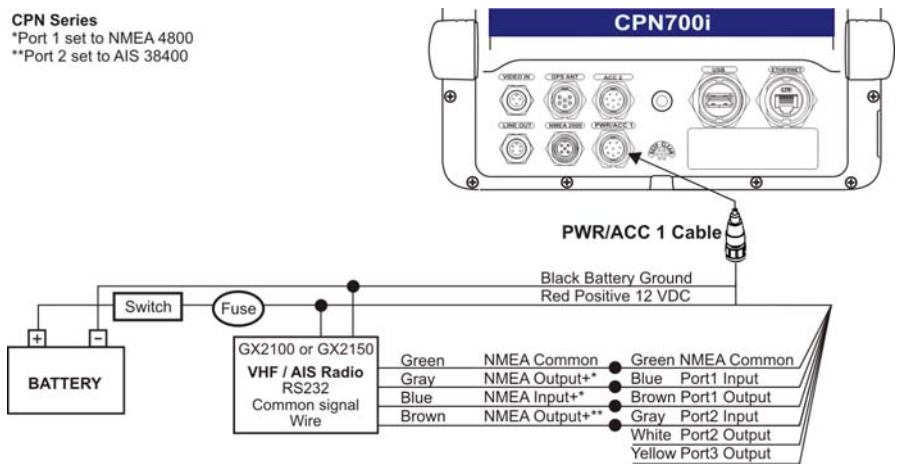

3 Fish Finder and VHF/AIS and Autopilot Connection

By default the CPN Series Chart Plotters PWR/ACC1 Port2 connection is set to Fish Finder. When an optional FF525 is connected Port2 Input (Gray) and Output (White) wires are not used for connections to other devices.

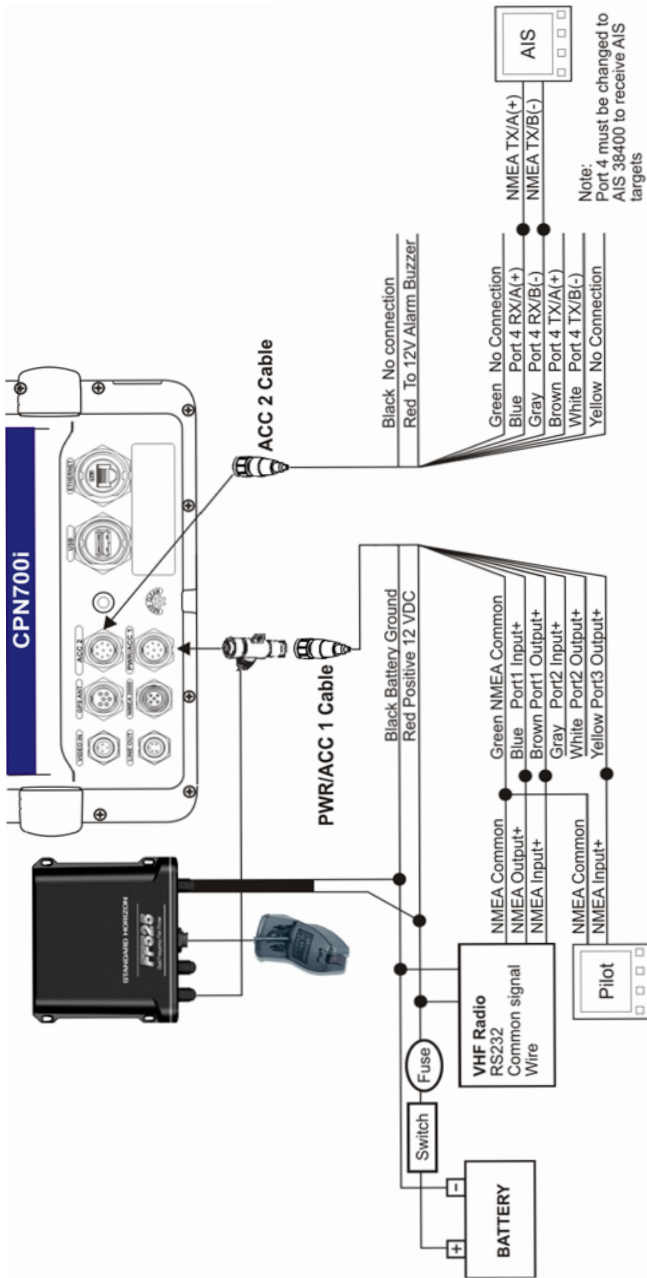

7.1.3 VIDEO INPUT CONNECTOR

| CPN700i/CPN1010i VIDEO Input Connector | | |
|--|---------------|--|
| Pin | Description | Connection Example |
| 2 | Ground | Connect to Video Signal Ground of DVD/VCR/Video Cameras |
| 3 | NC | NC |
| 1 | Video Signal+ | Connect to Video Signal+ (NTSC/PAL) of DVD/VCR/Video Cameras |

ⓘ The camera must be powered externally as the CPN Series Chart Plotters video jack does not supply a DC power source for the camera.

7.1.4 VIDEO INPUT CONNECTIONS FOR CPN700i

The CPN700i has:

- **1 NTSC or PAL Compatible Input:** NTSC or PAL Video Input allows a camera, DVD or VCR to be connected. To connect a video source use the optional ACVC10 cable (3 pin to RCA phone adapter).

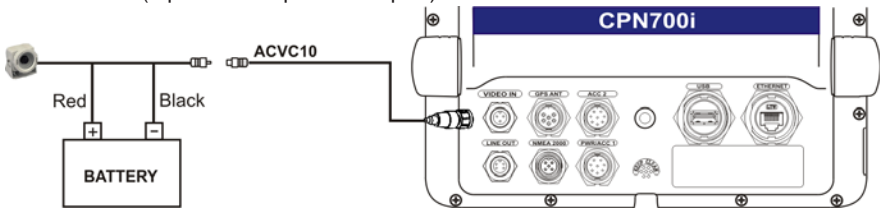

7.1.5 VIDEO INPUT/OUTPUT CONNECTIONS FOR CPN1010i

The CPN1010i has:

- **1 VGA output:** allows connection to a compatible TV or monitor using the optional VGAC10 adapter cable.
- **2 NTSC or PAL Compatible Inputs:** NTSC or PAL Video Inputs allow a camera, DVD or VCR to be connected. To connect a video source, use the optional ACVC10 cable (3 pin to RCA phone adapter).

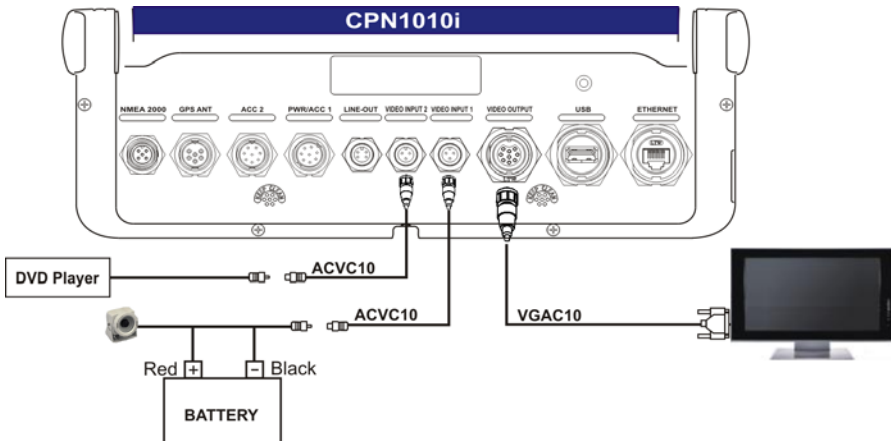

| CPN1010i VIDEO Output Connector | |
|---------------------------------|-------------|
| Pin | Description |
| 1 | VIDEO-GND |
| 2 | NC |
| 3 | Video-Red |
| 4 | Video-Green |
| 5 | Video-Blu |
| 6 | H-Sync |
| 7 | V-Sync |
| 8 | NC |
| 9 | NC |

ⓘ The CPN1010i VGA output resolution is 1024x600. To be able view the CPN1010i display, the monitor (or TV) must be selected to a resolution of 1024x600.

7.1.6 PRE-AMP OUTPUT - EXTERNAL AMPLIFIER/SPEAKER CONNECTIONS

The CPN Series Chart Plotter has a Pre-Amp Output designed to connect to an External Amplifier. To connect an External Amplifier to the Pre-Amp Output an optional ACAC10 adapter cable will have to be purchased separately. The following is an example of connections:

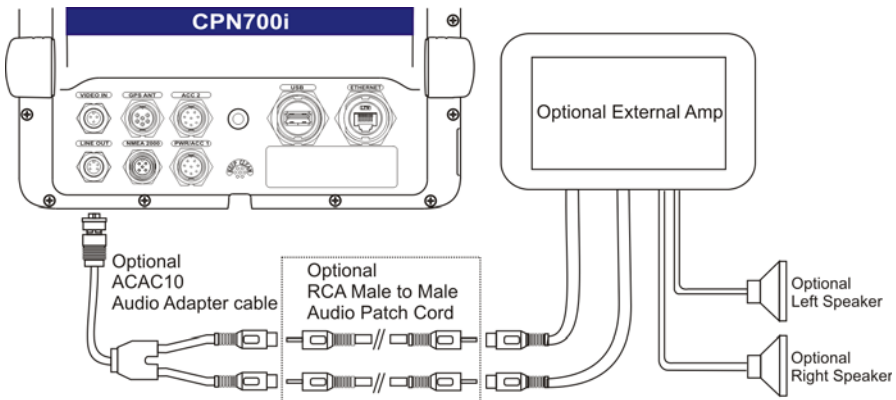

CPN Pre-Amp connector pin out

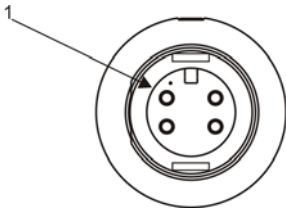

| CPN700i/CPN1010i LINE Output Connector | |
|--|-----------------------|
| Pin | Description |
| 1 | Channel right + |
| 2 | Channel right - (GND) |
| 3 | Channel left + |
| 4 | Channel left - (GND) |

7.1.7 OPTIONAL USB THUMB DRIVE

A USB Thumb Drive may be connected or removed from a CPN Series Chart Plotter rear panel connector at any time. The Thumb Drive may be loaded with the movies, pictures and songs from a PC before inserting and be accessed using the Media Player (refer to Chapter 5 “Media Player”). Below is an example of USB Thumb Drive connection:

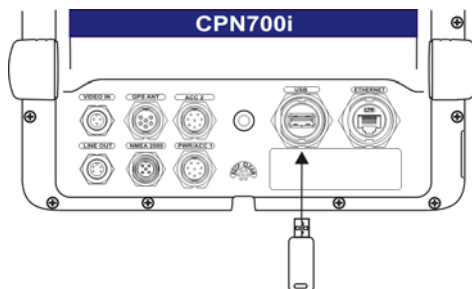

7.1.8 OPTIONAL GPS ANTENNA

Refer to Par. 8.4 “Optional WAAS GPS Receiver”.

7.1.9 OPTIONAL FF525 BLACK BOX FISH FINDER

Refer to Par. 8.3 “Optional FF525 Fish Finder”.

7.1.10 OPTIONAL EXTERNAL ALARM CONNECTION

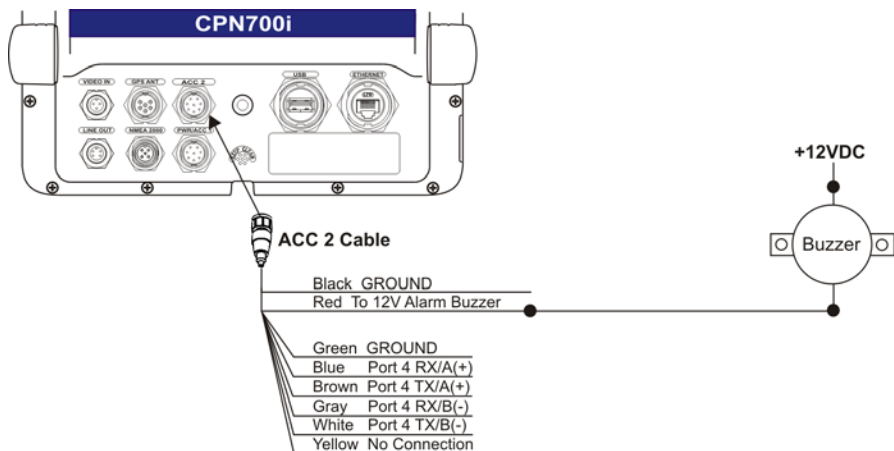

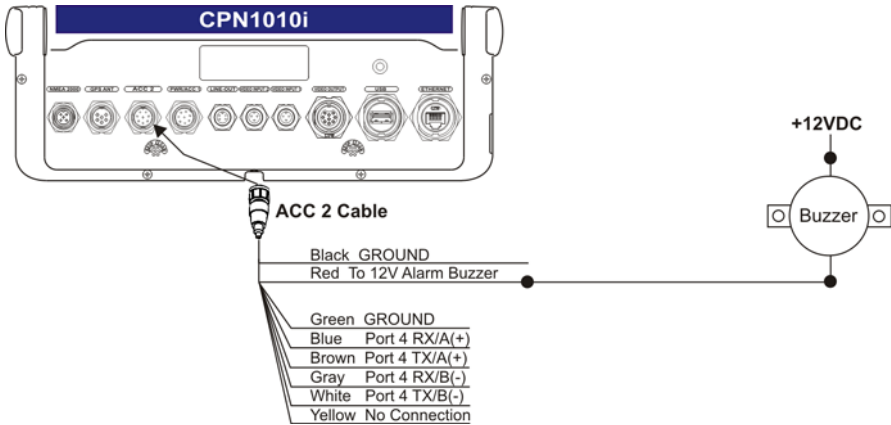

7.1.11 SECOND CPN TO SHARE C-MAP 4D CHARTS, NMEA & FF DATA

Two CPN Series Chart Plotters may be linked together using an optional Ethernet Crossover Cable to share optional Ethernet Crossover Cable to share optional C-MAP 4D cartography, NMEA and Fish Finder data. Connections are shown below. Refer also to Par. 3.5 “Networking Connection: C-MAP 4D Charts, NMEA & Fish Finder Data Sharing”.

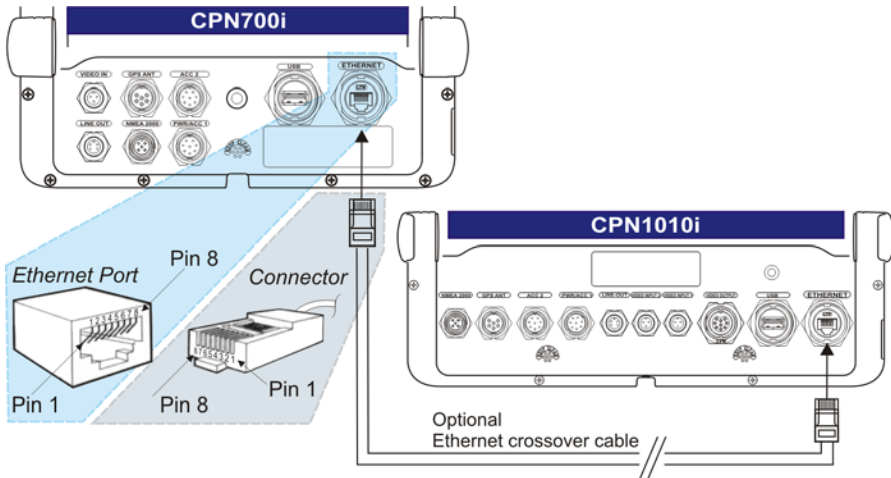

Crossover Cable table

| Name | Pin Connector 1 | Pin Connector 2 | Name |
|------|-----------------|-----------------|------|
| TX+ | 1 | 3 | RX+ |
| TX- | 2 | 6 | RX- |
| RX+ | 3 | 1 | TX+ |
| RX- | 6 | 2 | TX- |

7.1.12 NMEA-2000 DEVICES

The CPN Series Chart Plotters allow connection to a NMEA-2000 network, to connect marine electronic equipment on vessels. The devices connected by NMEA-2000 have the ability to share data with other devices over a single bus. The following is an example of a NMEA-2000 connection:

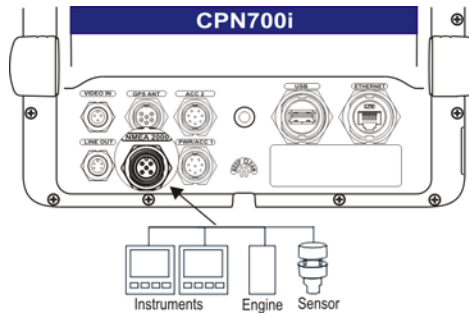

The list of PGNs is shown in the "Specification" Chapter, Par. 8.1 and 8.2. For more information please visit www.nmea.org.

8 - SPECIFICATIONS

8.1 CPN700i

| | |
|--------------------------------------|---|
| Power Supply | : 10-35 VDC |
| Power Consumption | : 11W max Current Draw: 0.92A@12VDC |
| Display | : 7" Wide VGA Resolution: 800x480 Sunlight viewable Backlight: LED (1000nits) Touchscreen: Capacitive |
| Cartography | : C-MAP 4D SD CARD |
| Operating temperature range | : 32°F/+131°F (0°C/+55°C) |
| Storage temperature | : -4°F/+158°F (-20°C/+70°C) |
| Keyboard | : Silicon rubber, LED backlight |
| Weight (without bracket) | : 2.7 Lbs (1200 g) |
| User Points (Marks/Waypoints) | : 10000 |
| Routes | : 50 |
| Track Points | : 10000 (recordable in 20 Tracks) |
| NMEA-0183 Output sentences | : GLL, VTG, BWC, WCV, APA, APB, HDG, BOD, XTE, RMA, RMB, RMC, GGA, HSC, DBT, DPT, MTW, VHW. |
| NMEA-0183 Input sentences | : BWC, DBT, DPT, DSC, DSE, GGA, GLL, GSA, GSV, HDG, HDM, HDT, MTW, MWD, MWV, RMC, RTE, TLL, VDM, VHW, VTG, VWR, VWT, WPL. |
| NMEA-2000 Output PGNs | : 127258, 128259, 128267, 129026, 130312, 126992, 129025, 129029, 129033, 128275, 129808, 129539, 129540, 129283, 129284, 129285. |
| NMEA-2000 Input PGNs | : 126992, 127245, 127250, 127258, 127488, 127489, 127497, 127505, 128259, 128267, 129025, 129026, 129029, 129033, 129038, 129039, 129040, 129540, 129794, 129798, 129808, 129809, 129810, 130306, 130310, 130311, 130312, 130314, 130577. |
| USB on rear panel | : USB A type (USB 2.0 480mb/s), USB stick |
| USB on front panel | : Micro-AB USB, USB stick (an adapter is required, for indoor use only) |
| LAN | : one RJ45 port, up to 100 Mbps (FastEthernet 100baseT). |
| Video Input | : 1 input, NTSC or PAL |
| Line Out | : 4VRMS (max) at 20K OHM |
| Wi-Fi® Antenna | : external SMA connector |
| Wi-Fi® Certification | : 802.11b/g/n |
| Bluetooth® | : v. 2.1 + EDR. HID (mouse and keyboard) profile only |

8.1.1 DIMENSIONS

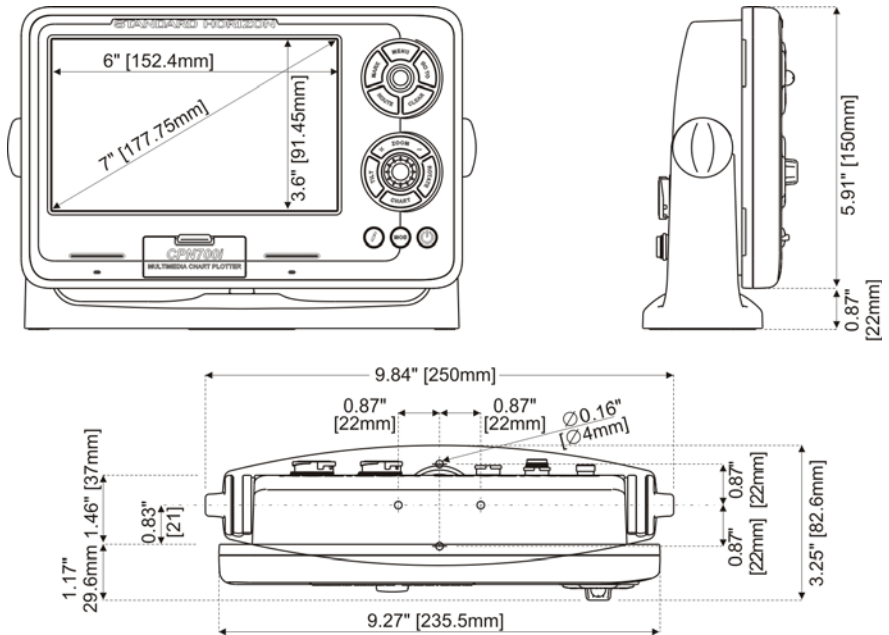

8.2 CPN1010i

| | |
|--------------------------------------|--|
| Power Supply | : 10-35 VDC |
| Power Consumption | : 19W max Current Draw: 1.6A@12VDC |
| Display | : 10" Wide SVGA Resolution: 1024 x 600 Sunlight viewable Backlight: LED (1000nits) Touchscreen: Capacitive |
| Cartography | : C-MAP 4D SD CARD |
| Operating temperature range | : 32°F/+131°F (0°C/+55°C) |
| Storage temperature | : -4°F/+158°F (-20°C/+70°C) |
| Keyboard | : Silicon rubber, LED backlight |
| Weight (without bracket) | : 4.4 lbs (2000 g) |
| User Points (Marks/Waypoints) | : 10000 |
| Routes | : 50 |
| Track Points | : 10000 (recordable in 20 Tracks) |
| NMEA-0183 Output sentences | : GLL, VTG, BWC, WCV, APA, APB, HDG, BOD, XTE, RMA, RMB, RMC, GGA, HSC, DBT, DPT, MTW, VHW. |

- NMEA-0183 Input sentences** : BWC, DBT, DPT, DSC, DSE, GGA, GLL, GSA, GSV, HDG, HDM, HDT, MTW, MWD, MWV, RMC, RTE, TLL, VDM, VHW, VTG, VWR, VWT, WPL
- NMEA-2000 Output PGNs** : 127258, 128259, 128267, 129026, 130312, 126992, 129025, 129029, 129033, 128275, 129808, 129539, 129540, 129283, 129284, 129285.
- NMEA-2000 Input PGNs** : 126992, 127245, 127250, 127258, 127488, 127489, 127497, 127505, 128259, 128267, 129025, 129026, 129029, 129033, 129038, 129039, 129040, 129540, 129794, 129798, 129808, 129809, 129810, 130306, 130310, 130311, 130312, 130314, 130577.
- USB on rear panel : USB A type (USB 2.0 480mb/s), USB stick
- USB on front panel : Micro-AB USB, USB stick (an adapter is required, for indoor use only)
- LAN : one RJ45 port, up to 100 Mbps (FastEthernet 100baseT).
- Video Input : 2 inputs, NTSC or PAL
- Video Output : 1 output, VGA signals, 1024x600 resolution
- Line Out : 4VRMS (max) at 20K 0HM
- Wi-Fi® Antenna : external SMA connector
- Wi-Fi® Certification : 802.11b/g/n
- Bluetooth® : v. 2.1 + EDR. HID (mouse and keyboard) profile only

8.2.1 DIMENSIONS

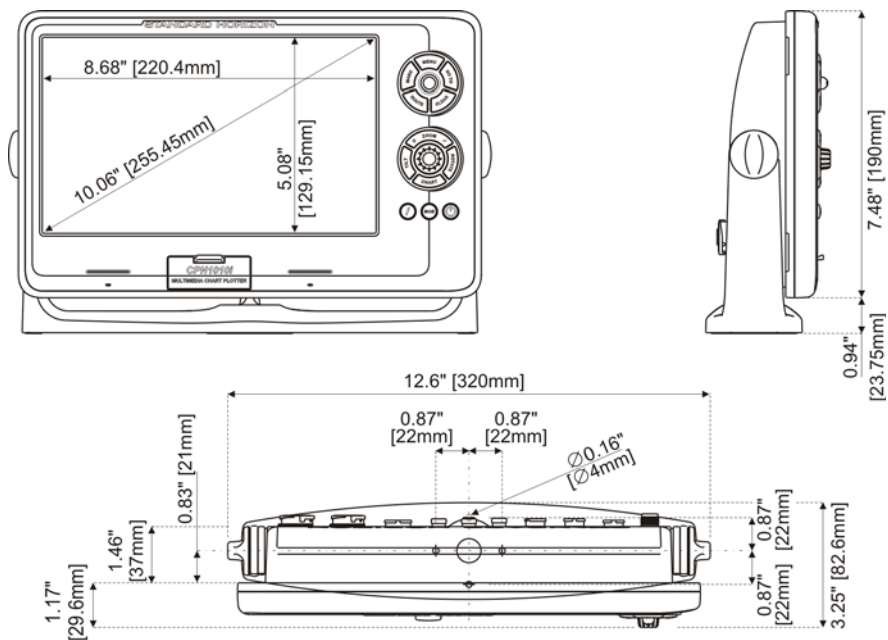

8.3 OPTIONAL FF525 FISH FINDER

Power Output : 600W or 1kW depending on connected transducer
 Frequency : 50 and 200kHz
 Minimum Depth : 5ft at 50kHz, 2.5ft at 200kHz
 Maximum Depth : 1500ft at 50kHz, 700ft at 200kHz
 Airmar X-DUCER ID : Must use STANDARD HORIZON transducers part numbers
 Advanced Digital Signal Processing
 Speed & Temperature Sensor (if available on transducer)
 Alarms (Shallow Water, Depth, Fish, Temp)
 Trip Log, Fish Symbols
 STC, Interference Rejection, Automatic noise reduction
 A-Scope, White Line, Zoom x2/x4
 Auto range/gain/frequency/shift/ping rate
 16/256 colors display user selectable

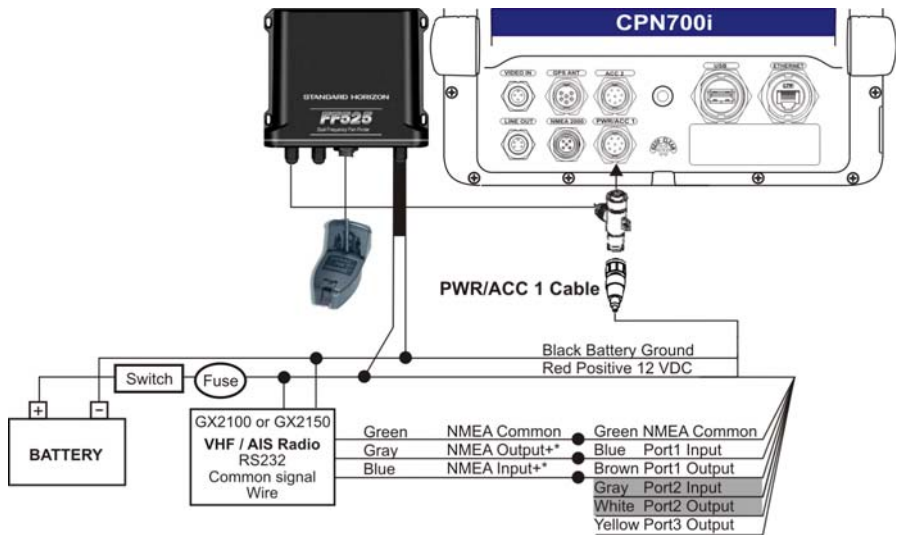

*Port1 Input must be changed to 38400 baud

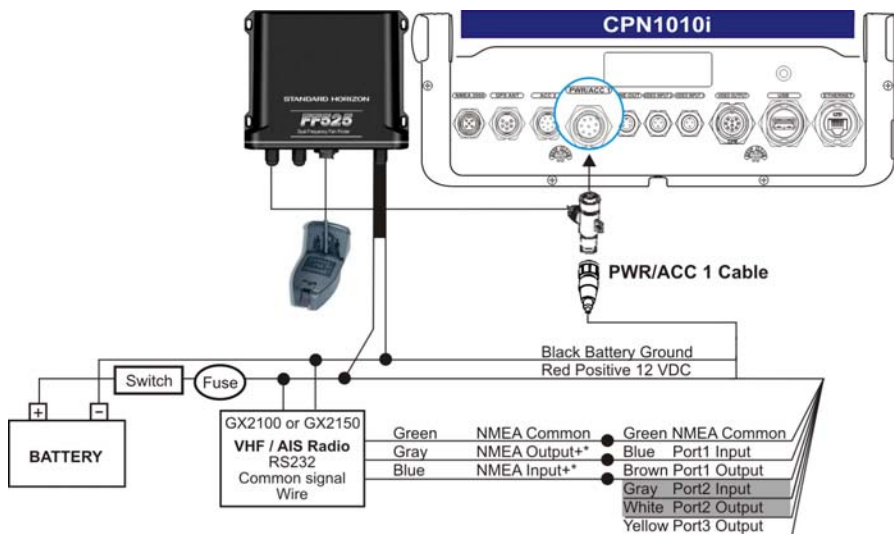

*Port1 Input must be changed to 38400 baud

8.4 OPTIONAL WAAS GPS RECEIVER

This optional WAAS GPS Receiver is based on an ultimate GPS engine that delivers accuracy better than 10ft by decoding the GPS correction signals from the satellite-based WAAS (*Wide Area Augmentation System*). The GPS engine, interface electronics and the passive antenna are enclosed inside the waterproof plastic housing. This provides advanced state of the art GPS performance in an easy to use package.

Physical Characteristics

| | |
|------------------------|--|
| Color | Ivory white |
| Dimensions | 97mm in diameter x 32mm in height (flush mounted) or 61,5mm on flag-pole mount |
| Weight (without cable) | 0.35 lb (160 g) |
| Cable | white 15m 8x28AWG cable with 6 pins female connector |

Electrical Characteristics

| | | |
|--------------------------|------------------------------|-----------|
| Input Voltage | 10 VDC to 35 VDC unregulated | |
| Input Current | 0.8 Wmax | |
| GPS Receiver Sensitivity | Tracking, Navigation | :-160 dBm |
| | Acquisition, Reacquisition | :-160 dBm |
| | Cold Starts | :-145 dBm |

GPS Performance

| | | |
|-------------------------|-------------------------|--|
| GNSS Systems | GPS | : L1 C/A |
| | GALILEO | : L1 |
| | SBAS | : WAAS (North America), EGNOS (Europe), MSAS (Asia), GAGAN (India) |
| Geodetic Datum | WGS84 | |
| Channels | 32 + 18 | |
| Acquisition Time | | |
| Reacquisition | < 1 second | |
| Hot Start | 1 second | |
| Warm Start | 29 seconds | |
| Cold Start | 29 seconds | |
| Accuracy | | |
| GPS | < 10ft | |
| with SBAS | < 2.0m | |
| NMEA Output | | |
| Messages | GGA, RMC, GSA, GSV, TXT | |

8.4.1 GPS CONNECTION IMAGE

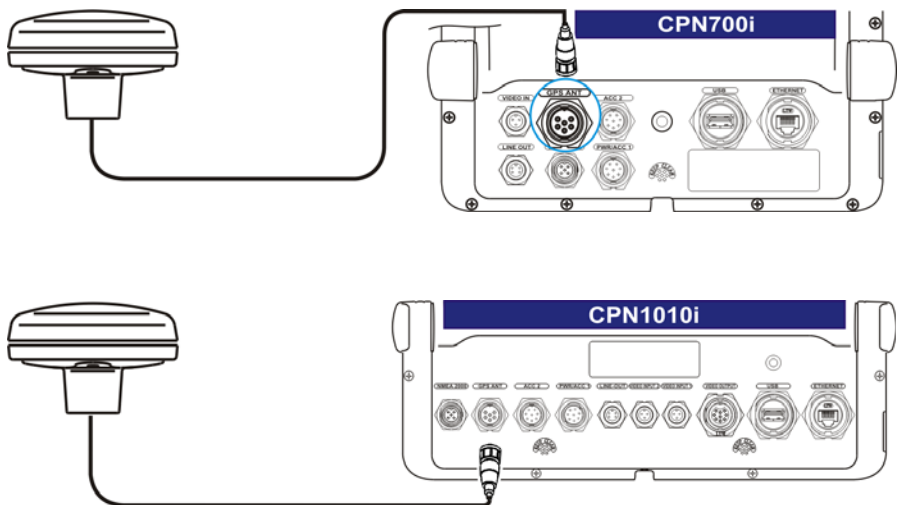

9 - TECHNICAL TESTS

9.1 SYSTEM TEST

If you have connected your CPN Series Chart Plotter according to the instructions, and chosen the proper menu selection for your device, and are still having problems with your CPN Series Chart Plotter, the extended auto-test should help determine the problem. To enter the System Test it is needed to hold down any key while the Chart Plotter application is starting:

1. Select the Startup Screen page.

2. Tap on the Plotter Icon  , when the STANDARD HORIZON Splash Screen page is shown, press and hold the **CLEAR** key until the System Test display is shown, then let go of the **CLEAR** key. A new menu will appear on the display:



Choose the test and tap on it. To exit from the System Test choose **EXIT** option.

9.1.1 RAM MENU (RESET)

 After performing a RAM Clear all Marks, Routes, Tracks and C-Weather data will be erased.

RAM Clear

All the internal memory can be erased and the default setting restored. If the CPN Series Chart Plotter exhibits unusual operations, or appears to be malfunctioning, it may be possible to correct the problem by clearing RAM.

This operation will erase all Marks, Routes, stored Track plots, Destinations and C-Weather data. It will also return all selections (Input Data Format, Autopilot selection, etc.) to original default values. To confirm clear RAM press the  ShuttlePoint knob (but if at this time you do not wish to clear RAM press the **CLEAR** key).

9.1.2 BACKLIGHT

Each time you move the  ShuttlePoint knob to the left, the screen will decrease brightness, move it to the right to increase brightness.

9.1.3 CARTRIDGES (USED BY STANDARD HORIZON TECHNICIANS)

Internal Data Base Test

To test the Worldwide Background.

SD CARD Test

To test the SD CARD. There are the possible situations:

1. If there is an SD CARD inserted in the slot and there is not a malfunction, the name of the SD CARD zone and the message "OK" are shown.
2. If there is an SD CARD inserted in the slot, but it is a defective SD CARD, the name of the SD CARD zone and the message "Faulty" are shown.
3. If there is not any SD CARD inserted in the slot, the message "not present" is shown.



9.1.4 SERIAL PORTS (USED BY STANDARD HORIZON TECHNICIANS)

If you are having problems receiving data from the position-finding instrument, this test should help determine the problem.

Change Parameters

To change the parameters of the serial interface. This menu allows selecting the **Port** (Signal Source) between Port1, Port2, Port3, Port4; the **Baud Rate** between 300, 1200, 2400, 4800, 9600, 38400, 115200; the **Data Bits** (Word Length) between 7 or 8, the **Parity** between even, odd or none, the **Stop Bits** between 1 or 2. Default settings are: Port = PORT2, Baud Rate = 4800, Data Bits = 8, Parity = none, Stop Bits = 1.

Input Data Display

To allow the CPN Series Chart Plotter to act as a computer terminal and display the incoming data exactly as it is received. If the data displayed on the screen is unrecognizable, you may have selected the wrong input parameters for your particular receiver, for example, Baud Rate 9600 instead of Baud Rate 4800. Check your receiver manual to be sure that you have selected the proper parameter. If the screen is blank, you may have a broken connection, and no data is being received or you may have connected the device to the other input port. Use the  key to stop (or continue after pausing) data displaying, press the  ShuttlePoint knob to show data in hex or ASCII mode and the  key to exit.

Loop-Back Test

This is a special test done during the production phase to check the serial ports integrity. A special connector is required.



10 - SYSTEM UPDATE

10.1 SYSTEM UPDATE PROCEDURE

After downloading the Installation Package or contacting your dealer to obtain the proper Installation Package, follow the procedure below to update the system:

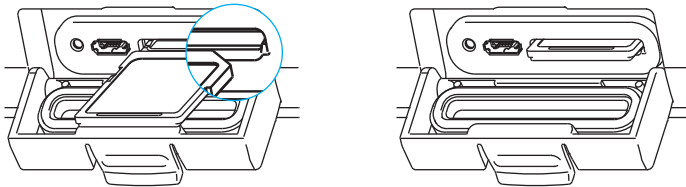
1. Install the Installation Package on an SD CARD.
2. Press the  PWR key to turn the CPN Series Chart Plotter Off.
3. Insert the SD CARD into the slot.



4. Press and hold the  PWR key to turn on the CPN Series Chart Plotter.
5. The Operating System (OS) installation starts. When completed, the CPN Series Chart Plotter automatically restarts.
6. The package update window appears (see A).
The CPN Series Chart Plotter checks the integrity of the Installation Package present on the SD CARD. This operation might require several minutes (if you want to abort the installation tap on ).

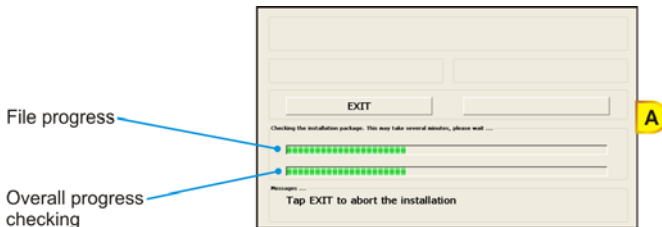

At the end of the checking, the package update window shows the following data (see B):

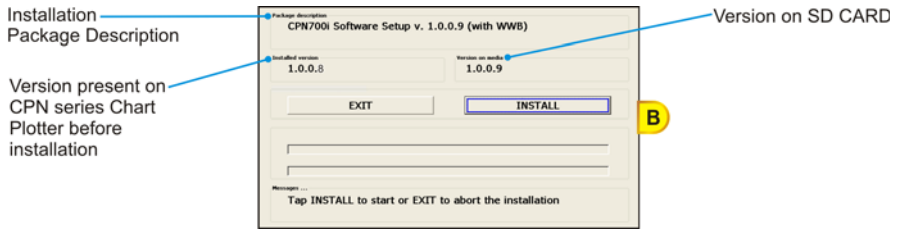

The **INSTALL** touchscreen key is now selected (it appears with blue frame).

7. Tap on **INSTALL** to start installation (or tap on **EXIT** to abort).

⚠ Otherwise move the ShuttlePoint knob to place cursor on **INSTALL** (or on **EXIT** to abort) and then press the ShuttlePoint or rotary knob.

8. The installation process begins.

Pay attention: do not turn the CPN Series Chart Plotter Off during installation.

The installation status appears in the two progress bars on the bottom of the package update window (see C):

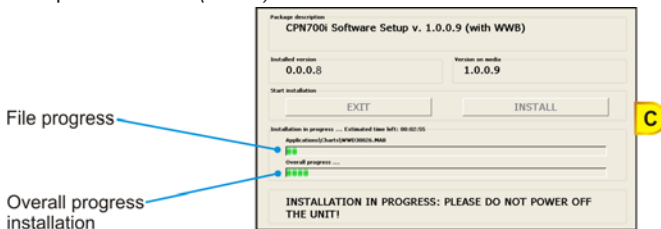

9. At the end of the installation process, the Startup Screen page is shown.

10. To complete the update system procedure, press the **PWR** key to turn the CPN Series Chart Plotter Off and remove the SD CARD from the slot.

11. Then press and hold the **PWR** key to turn the CPN Series Chart Plotter On: the system is now updated and ready to use.

10.2 SYSTEM UPDATE ERROR MESSAGES

Below there is the list of the error messages that can occur while updating system with the relative explanation and problem solving procedure.

10.2.1 ERROR MESSAGES 01, 02, 03, 04, 05, 06, 07, 09

- **Error 01 - INFO.DAT file not found**
The file info.dat was not found on the memory device
- **Error 02 - INFO.DAT file corrupted**
The file info.dat on the memory device is corrupted

- **Error 03**

ATTENZIONE: file di aggiornamento non valido per questo dispositivo

WARNING: wrong update file

ATTENTION: fichier de mise à jour non compatible avec ce dispositif

WARNUNG: falsche Updateakte

CUIDADO: ficheros de actualización no válidos para este dispositivo

ATENÇÃO: dados de atualização não válidos para este dispositivo

The Installation Package on the memory device is not suitable for the CPN Series Chart Plotter

- **Error 04 - Update File corrupted**

The Installation Package files on the memory device are corrupted

- **Error 05 - Xloader wrong file size**

The Installation Package files on the memory device are corrupted

- **Error 06 - Boot wrong file size**

The Installation Package files on the memory device are corrupted

- **Error 07 - OS wrong file size**

The Installation Package files on the memory device are corrupted

- **Error 09 - Cannot find any component to update**

The Installation Package does not contain all the required files

If one of the these messages appears, press the  PWR key to turn Off the CPN Series Chart Plotter and then follow the procedure:

1. Download the Installation Package again and install it on the SD CARD (or contact your dealer to obtain the proper Installation Package).
2. Repeat the installation procedure.

10.2.2 ERROR MESSAGE 08

- **Error 08 - SD card not recognized**

The CPN Series Chart Plotter does not recognize the SD CARD in the slot or the SD CARD slot is damaged

If this message appears, press the  PWR key to turn Off the CPN Series Chart Plotter and then follow the procedure:

1. Download the Installation Package again and install it on a different SD CARD (or contact your dealer to obtain the proper Installation Package).
2. Repeat the installation procedure.
3. If the problem persists, contact your dealer to check the SD CARD slot on the CPN Series Chart Plotter.

10.2.3 ERROR MESSAGES 20, 21, 22

- **Error 20 - Update SD card not present: System Halted**

The Operating System is not installed in the CPN Series Chart Plotter and no Installation Package SD CARD inserted

- **Error 21 - UPLOAD Folder not found: System Halted**

The Operating System is not installed in the CPN Series Chart Plotter and the inserted SD CARD does not contain a valid Installation Package

- **Error 22' - OS Image Corrupted: System Halted**

The Operating System in the CPN Series Chart Plotter is corrupted

 It might occur when the Operating System gets corrupted (for any reasons regardless of installation procedure).

If one of these messages appears, press the  PWR key to turn Off the CPN Series Chart Plotter and then follow the procedure:

1. Download the Installation Package and install it on the SD CARD (or contact your dealer to obtain the proper Installation Package).
2. Execute the installation procedure.

TERMS

AES (*Advanced Encryption Standard*): Wi-Fi® authorized strong encryption standard. It uses a Pre-Shared Key (PSK) that is 8 or more characters in length, up to a maximum of 63 characters.

AIS (*Automatic Identification System*): Improves the safety of navigation by assisting in the efficient operation of ship-to-ship location reporting and VTS applications.

AIS-EPIRB: EPIRB (*Emergency Position-Indicating Radio Beacon*) device with AIS transmitter.

AIS-MOB: Man Over Board Device (*Maritime Survivor Locating Device*) with AIS transmitter.

AIS-SART: SART (*Search And Rescue Transponder*) device with AIS transmitter.

ALT (*Altitude*): Shows the Altitude of the GPS antenna on the mean sea level. It is received from GPS, sentence GGA.

A-P: Atmospheric Pressure

A-T: Air Temperature

AWD (*Apparent Wind Direction*): Shows the Apparent Wind Direction when a external wind instrument with NMEA is connected.

AWS (*Apparent Wind Speed*): Shows the Apparent Wind Speed when a external wind instrument with NMEA is connected.

BRG (*Bearing*): The direction from your current position to a Destination point.

COG (*Course Over Ground*): The course your vessel is heading.

DATE: Shows the current date received by the GPS.

DEPTH AREAS: Sea areas included in the user selectable range of minimum and maximum depth limits.

DEW: Dew point Temperature

DPT (*Depth*): Shows the water depth when the optional FF525 50/200kHz BLACK BOX FISH FINDER or digital Depth Sounder is connected.

DRAUGHT: Depth of water the vessel draws. The definition of **draught** (or **draft**) of a ship's hull is the vertical distance between the waterline and the bottom of the hull (keel). Draught determines the minimum depth of water a ship or boat can safely navigate. On the Tide page the **draught** window shows the height of the tidal water during a 24hr period of time. This height is dependent on the time of day.

DSC (*Digital Selective Calling*): Semi-automated method of establishing a VHF Radio Call. DSC had also been designated as part of the Global Maritime Distress and Safety System (GMDSS). It is planned that DSC will eventually replace aural watches on distress frequencies and will be used to announce routine and urgent maritime safety information broadcasts.

DST (*Distance*): The distance from your current position to a Destination point.

E-BST: Engine Boost Pressure

E-C-PRS: Engine Coolant Pressure

E-HRS: Engine hours total

E-LOAD: Engine Load Percent

E-PRS: Engine Oil Pressure

E-SPD: Engine Speed

ETA: Estimated Time of Arrival

E-TEMP: Engine Temp

E-TORQ: Engine Torque Percent

E-TRM: Engine tilt/trim

F-PRS: Fuel Pressure

F-RATE: Fuel Rate

F-RATEA: Fuel Rate, Average

F-RATEE: Fuel Rate, Economy

F-RATEIE: Instantaneous Fuel Economy

F-TRIP: Trip Fuel Used

GPS Constellation: The Global Positioning System (GPS) is a space-based radio-navigation system consisting of a constellation of satellites and a network of ground stations used for monitoring and control. A minimum of 24 GPS satellites orbit the earth at an altitude of approximately 11,000 miles providing users with accurate information on position, velocity and time anywhere in the world and in all weather conditions.

GPS2D: The GPS is receiving at least 2 satellites.

GPS3D: The GPS is receiving at least 3 satellites.

HDG (Heading): Shows heading from an external Flux Gate Compass when connected.

HDOP/VDOP (Horizontal/Vertical Dilution of Precision): Parameter indicating the precision of the positioning system (GPS). The smaller the HDOP/VDOP value, the more accurately the position fix is provided.

HEIGHT: The current Tide Height referred to the vertical cursor.

HIGH WATER: The maximum level of the Tide Height in 24 hours.

LOW WATER: The minimum level of the Tide Height in 24 hours.

LVL-BW: Fluid level Black Water

LVL-FUEL: Fluid level Fuel

LVL-FW: Fluid level Fresh Water

O-TEMP: Engine Oil Temp

PINGO: Mound of earth-covered ice found in the Arctic and subarctic that can reach up to 70m (230ft) in height and up to 600m (2,000ft) in diameter.

Position Request: Marine DSC VHF Function of transmitting a GPS position to another Marine DSC VHF. When CPN Series Chart Plotter is connected to STANDARD HORIZON GPS the position of another vessel is shown on the Chart page.

Raster Chart: Representation of the drawing through a collection of points describing color information, without any other kind of enrichment (usually it is the result of a scanning process).

RUDDER: Rudder Angle

SOG (Speed Over Ground): The speed your vessel is travelling at.

SPD (Speed): Shows the Speed Thru the Water when a digital Speed Log is connected.

STR (Steer): Heading to steer to destination Waypoint.

TIME: Shows the current time received by the GPS.

TKIP (Temporal Key Integrity Protocol): Encryption method. TKIP provides per-packet key mixing a message integrity and re-keying mechanism. It uses a Pre-Shared Key (PSK) that is 8 or more characters in length, up to a maximum of 63 characters.

TLOG (Trip Log): Shows the distance the vessel has travelled since the Trip Log was reset.

TWD (True Wind Direction): Shows the True Wind Direction when an external wind instrument with NMEA is connected.

TWS (True Wind Speed): Shows the True Wind Speed when an external wind instrument with NMEA is connected.

TTG (Time To Go): Shows time to go to reach a Destination point.

UNITS

Nm Nautical Mile (1Nm = 1.15SM or 1.85km)

SM Statute Mile (1SM = 0.87Nm or 1.61km)

km kilometer (1km = 0.62SM or 0.54Nm)

ft feet (1ft = 0.167m or 0.305m)

ftm Fathom (1ftm = 6ft or 1.83m)

m meters (1m = 3.28ft or 0.55ftm)

kn knots (1kn = 1.15mph or 1.85km/h)

mph miles per hour (1mph = 0.87kn or 1.61km/h)

km/h kilometer per hour (1km/h = 0.54kn or 0.62mph)

Vector-based Chart: A set of structured information concerning with shapes, lines, points, areas, Routes and it is enriched with several kinds of attributes and information. This approach permits to access to the chart not only as a static visualization of a drawing but also to manage the information, and the attributes that it contains, working as a Geographic Information System, that is a kind of geographic database.

VEL: Max Speed Log

VMG: It is the destination closing Velocity. The VMG is calculated using the current speed of the vessel (SOG) and the difference between the current vessel course and the bearing to the Destination.

WAAS 2D/3D: The GPS is receiving a 2D or 3D position and the correction from the WAAS Satellite. WAAS consists of approximately 25 ground reference stations positioned across the United States that monitor GPS satellite data. Two master stations, located on either coast, collect data from the reference stations and create a GPS correction message. This correction accounts for GPS satellite orbit and clock drift plus signal delays caused by the atmosphere and ionosphere. The corrected differential message is then broadcast through one of two geostationary satellites, or satellites with a fixed position over the equator. The information is compatible with the basic GPS signal structure, which means any WAAS-enabled GPS receiver can read the signal.

W-T (Water Temperature): Shows the sea water temperature when the FF525 50/200kHz BLACK BOX FISH FINDER or a digital Speed Log/Temp instrument with NMEA is connected.

WEP (Wired Equivalent Privacy): Open System authentication: the WLAN client need not provide its credentials to the Access Point during authentication. Thus, any client, regardless of its WEP keys, can authenticate itself with the Access Point and then attempt to associate. After the authentication and association, WEP can be used for encrypting the data frames.

WPA™ (Wi-Fi Protected Access®): Initial WPA version, to supply enhanced security over the older WEP protocol. Typically uses the TKIP encryption protocol.

WPA2™ (Wi-Fi Protected Access® II): Successor of WPA, replaces the TKIP encryption protocol with AES to provide additional security.

WPA™-Personal (Wi-Fi Protected Access®-Personal): Also referred to as WPA-PSK (Pre-shared key) mode. Is designed for home and small office networks and doesn't require an authentication server. Each wireless network device authenticates with the access point using the same 256-bit key.

XTE (Cross Track Error): The distance your vessel is off course (left or right) to a Destination point.

ANALYTICAL INDEX

| | |
|---|--|
| & HIGHWAY | 86, 94 |
| °C | 37 |
| °F | 37 |
| 200kHz & CHART | 100 |
| 2D | 16, 22, 26, 27, 28, 39, 42, 44, 53, 54, 69, 96, 119, 176 |
| 3 Dimensional Chart View | 42 |
| 3D | 11, 16, 22, 27, 28, 36, 39, 41, 42, 44, 53, 54, 69, 94, 96, 176 |
| 3D Exaggeration Factor | 54 |
| 3D View | 11 |
| 4D FUNCTIONS | 52 |
| 50kHz & CHART | 100 |
| A | |
| A-P | 88, 174 |
| A-Scope | 165 |
| A-T | 87, 174 |
| About page | 39, 40, 44, 82, 111, 128 |
| ACAC10 adapter cable | 158 |
| ACC1 | 12, 109, 149 |
| ACC2 | 12, 149, 152, 154 |
| Access Point | 176 |
| ACCESSORIES | 13 |
| Accessories | 12 |
| Accessory cables | 149, 152 |
| ACCURACY | 71 |
| Accuracy | 167 |
| ACQUIRING | 96 |
| Acquisition Time | 167 |
| Activation Range | 114 |
| Active Target | 114 |
| ACTIVE TRACK | 80 |
| ACVC10 | 103, 157 |
| Adapter Cable | 103 |
| Add-Favorite | 136 |
| Additional Secondary phase Factor | 107 |
| Advanced Setup | 34, 106 |
| AES | 174 |
| AIFF | 138 |
| Air Pressure | 37 |
| Air Temperature | 87, 117, 174 |
| Airmar X-DUCER ID | 165 |
| AIS | 12, 109, 113, 114, 115, 148, 154, 155, 174 |
| AIS List | 12, 116 |
| AIS-EPIRB | 12, 115, 116, 174 |
| AIS-MOB | 12, 115, 116, 174 |
| AIS-SART | 12, 115, 116, 174 |
| alarm condition | 42, 56 |
| Alarms | 104, 105, 165 |
| Alaska | 11, 21, 39 |
| ALT | 87, 174 |
| Alternate Solution | 107 |
| Altitude | 37, 87, 174 |
| Analog page | 98 |
| Anchor Alarm | 105 |
| Antenna | 147, 148 |
| APA | 110, 162, 163 |
| APB | 110, 162, 163 |
| Apparent Wind Direction | 87, 174 |
| Apparent Wind Speed | 87, 174 |
| Arrival Alarm | 105 |
| ASCII | 169 |
| ASF1/2 | 107 |
| Asia | 167 |
| Assigning Page Soft Keys | 32 |
| assistance | 41 |
| Atmospheric Pressure | 88, 174 |
| Attention Areas | 91 |
| Audible Alarm | 105 |
| Audio Amplifier | 148 |
| Authentication Protocols | 123 |
| AUTO | 100 |
| AUTO INFO | 38 |
| Auto Info | 89, 111 |
| Auto Position | 111 |
| AUTOMATIC CHECK | 71 |
| Automatic Identification System | 113 |
| Autopilot | 168 |
| Autopilot Connection | 155 |
| Available free Track point | 87 |
| AWD | 87, 174 |
| AWS | 87, 174 |
| B | |
| background colors | 38 |
| BACKLIGHT | 169 |
| backlight | 11, 15, 104, 162, 163 |
| backup | 81 |
| Bahamas | 11, 21, 39 |
| bar | 37 |
| BATTERY CONNECTIONS | 149 |
| Battery Connections | 148 |
| Baud Rate | 169 |
| Beacons | 58, 91 |
| Bearing | 26, 27, 75, 88, 97, 174 |
| Bearing to navigated point | 87 |
| Beaufort | 37 |
| beep | 20, 37, 105 |
| bft | 37 |
| Bluetooth® | 11, 14, 128, 129, 130, 131, 162, 164 |
| BMP Decoder | 138 |
| Boat Ground | 150, 151, 152 |
| BOD | 110, 162, 163 |
| Bookmarks | 136 |
| Boundaries Mode | 91, 92 |
| bracket installation | 144 |
| Bracket knob | 12 |
| BRG | 26, 75, 87, 88, 95, 97, 174 |
| Bridges | 71 |
| Brightness | 15, 16, 22 |
| brightness | 104, 169 |
| BRIGHTNESS CONTROL | 15 |
| Browser | 11, 14, 25, 132, 133, 136, 137, 142 |
| Browser Home page | 133 |
| Browser Icon | 132, 133 |
| Built-In Charts | 11, 21, 26, 38, 39, 41, 44, 58, 92, 111, 112 |
| Buoys | 58, 89, 91 |
| BWC | 110, 162, 163, 164 |
| C | |
| C-MAP 4D | 11, 16, 21, 22, 39, 41, 42, 43, 44, |

| | |
|---|---|
| 92, 93, 105, 112, 124, 125, 128, 148, 160, 162, 163 | |
| C-MAP Weather | 12, 117 |
| C-Marina Port Database | 42 |
| C-Weather | 85, 117, 168 |
| CALIBRATION | 108 |
| Canada | 11, 21, 39 |
| Caribbean | 11, 21, 39 |
| Cartography | 11, 16, 162, 163 |
| Celsius | 37 |
| Central America | 11, 21, 39 |
| Chain | 34, 107 |
| change a page | 30 |
| change the SD CARD | 83 |
| Changing the Ship Icon | 29 |
| Channels | 167 |
| Chart Boundaries | 91, 92 |
| Chart Configurations | 90 |
| CHART CONTROL ICON | 38 |
| Chart Control Icon | 36 |
| Chart Datum | 107 |
| CHART DISPLAY | 22 |
| Chart Display | 27, 30, 52, 53, 54, 55, 56, 57, 58, 59 |
| CHART key | 16 |
| Chart Language | 57, 58 |
| Chart Lock | 91, 93 |
| Chart Menu | 16 |
| Chart Orientation Resolution | 107 |
| Chart page | 26, 27, 36, 38, 85, 88, 89, 94 |
| CHART PAGE WINDOW | 38 |
| Chart Plotter | 14, 25 |
| Chart Plotter Mode | 25 |
| Chart Scale | 87, 88 |
| Chart Settings | 92 |
| Chart Shading | 53, 54 |
| Chart Update Card | 39, 40 |
| Chart Window | 52 |
| Chart/Highway page | 85, 94 |
| CHECK ENGINE | 106 |
| Chinese | 35, 132 |
| Classic | 34, 38 |
| Cleaning | 16 |
| Clear Info | 42 |
| CLEAR key | 15 |
| clear RAM | 168 |
| Clear View | 42 |
| Close Soft Key | 24 |
| Closest Point of Approach | 113 |
| Closing Soft Keys | 24 |
| COG | 79, 85, 87, 95, 97, 107, 108, 110, 114, 174 |
| Collapsing Data Windows | 88 |
| Color Targets AIS | 12 |
| COMBO | 99 |
| Compass | 108 |
| Compass Indicator | 59 |
| Compass page | 31, 32, 35, 94, 95 |
| Compass Rose | 12 |
| Connect Icon | 120, 125, 126, 129 |
| Connection Manager | 14, 18, 25, 120, 121, 122, 123, 125, 127, 129 |
| CONNECTIONS | 148, 149, 152, 157, 158 |
| contrast | 104 |
| CONVENTIONS | 13 |
| Coordinate System | 34, 107 |
| Coordinates | 44, 51 |
| Course | 110 |
| Course Over Ground | 79, 87, 97, 174 |
| Course Time Line | 59 |
| Course Up | 30, 58 |
| COURSE UP/NORTH UP | 30 |
| Course Up/North Up | 58 |

| | |
|---------------------------------|---------------------------------|
| CPA | 113 |
| CPA Alarm | 113, 114 |
| CPA Limit | 113, 114 |
| CPN1010i | 11, 12, 104, 148, 157, 158, 163 |
| CPN700i | 11, 12, 104, 157, 162 |
| create a Route | 68 |
| CREATING A ROUTE | 66 |
| CREATING MARK | 61 |
| Cross Track Error | 87, 176 |
| Cross-Hair | 26 |
| Crossover Cable | 124, 160 |
| Cuba | 11, 21, 39 |
| Current Date | 87 |
| Current Time | 87 |
| Currents Prediction | 56 |
| Cursor Control | 110 |
| Cursor Mode | 21, 26, 27, 38, 76, 88 |
| CURSORSPEED | 29, 38 |
| CURSOR WINDOW | 38 |
| Cursor window | 26 |
| Custom | 90, 91 |
| Custom Setup | 128 |
| CUSTOMIZING A PAGE ICON | 85 |
| Customizing data boxes | 97 |
| Customizing Data Windows | 87 |
| D | |
| DAM Report page | 112 |
| dangerous objects | 42, 70 |
| Dangerous Target | 114 |
| Danish | 35, 132 |
| Data Access Manager Report page | 111 |
| Data Bits | 169 |
| Data Safety Indicator | 56, 93 |
| Data Source Priority | 97, 108 |
| Data Window | 89 |
| Data Window Selections | 86 |
| DATE | 87, 174 |
| Date | 108, 110 |
| DATE FORMAT | 37 |
| Datum | 107 |
| Daylight Saving | 32, 33, 37 |
| DBT | 110, 162, 163, 164 |
| dealer | 11, 172, 173 |
| Default Mode | 26 |
| default pages | 32 |
| default setting | 168 |
| DELETE | 80 |
| delete MOB | 22 |
| DELETING A FILE | 83 |
| DELETING A MARK | 62 |
| DELETING A MOB | 78 |
| DELETING A ROUTE | 69 |
| DELETING A TRACK | 80 |
| Demo Mode | 110 |
| Depth | 37, 87, 108, 124, 165, 174 |
| Depth Alarm | 105 |
| DEPTH AREAS | 174 |
| Depth contours | 39 |
| DEPTH LIMIT | 71 |
| Depth Range Max | 91, 92 |
| Depth Range Min | 91, 92 |
| Depth Settings | 92 |
| Depth Shading Mode | 91, 92 |
| Depth Sounder | 97, 99, 174 |
| Depths & Land Elevation | 42 |
| Desktop Icons | 84 |
| Destination | 168, 176 |
| Detailed World Background | 41 |
| DEW | 88, 174 |
| Dew point Temperature | 88, 174 |

| | |
|-----------------------------------|---|
| Diagram | 42, 60 |
| Diff Correction Source | 96 |
| Differential Correction | 96 |
| Diffusers | 70, 91, 93 |
| Digital Raster Charts | 42 |
| Digital Selective Calling | 101, 174 |
| DIMENSIONS | 163, 164 |
| Dimensions | 166 |
| Direction | 108 |
| Display | 11, 114, 162, 163 |
| DISPLAY COLOR | 38 |
| Display Color | 34, 35 |
| DISPLAY MODE | 27 |
| Display Mode | 53, 90 |
| DISTANCE | 79, 80 |
| Distance | 26, 27, 37, 75, 174 |
| Distance to navigated point | 87 |
| Distress Call | 101, 102, 111 |
| distributor | 11 |
| DivX | 138 |
| Download | 118 |
| DPT | 87, 110, 162, 163, 164, 174 |
| DRAUGHT | 174 |
| Dredged Areas | 70 |
| DSC | 12, 71, 101, 102, 103, 111, 114, 162, 164, 174, 175 |
| DSE | 162, 164 |
| DSI | 56, 93 |
| DST | 26, 75, 87, 174 |
| DUAL | 100 |
| Dual Chart | 12, 28, 52, 85, 86 |
| Dust cover | 12 |
| Dutch | 35, 132 |
| Dynamic Currents | 42 |
| E | |
| E-BST | 174 |
| E-C-PRS | 174 |
| E-HRS | 174 |
| E-LOAD | 174 |
| E-PRS | 174 |
| E-SPD | 174 |
| E-TEMP | 175 |
| E-TORQ | 175 |
| E-TRM | 175 |
| Easy Routing | 11, 12, 43, 71, 72, 73, 74, 75 |
| Edit Route | 21, 67, 68, 70 |
| EDITING A MARK | 61 |
| EGNOS | 96, 167 |
| EGR SYSTEM | 106 |
| Electrical Characteristics | 166 |
| ENGINE COMM ERROR | 106 |
| Engine & Chart (Combo) page | 99 |
| Engine Alarm Report | 105 |
| Engine Alarms | 12 |
| Engine Boost Pressure | 174 |
| Engine Coolant Pressure | 174 |
| ENGINE EMERGENCY STOP MODE | 106 |
| Engine hours total | 174 |
| Engine Load Percent | 174 |
| Engine Oil Pressure | 174 |
| Engine Oil Temp | 175 |
| ENGINE SHUTTING DOWN | 106 |
| Engine Speed | 174 |
| Engine Temp | 175 |
| Engine tilt/trim | 175 |
| Engine Torque Percent | 175 |
| ENGINE-0 | 105 |
| ENGINE-1 | 98, 105 |
| ENGINE-2 | 98, 105 |
| ENGINE-3 | 98 |
| Engines | 109 |
| English | 35, 36, 38, 57, 132 |
| Enhanced Mixing Levels | 42 |
| ENVIRONMENT | 87, 88, 98 |
| EPIRB | 114, 115, 116, 174 |
| ER | 71, 72, 75 |
| error messages | 171 |
| Estimated Time of Arrival | 87, 175 |
| ETA | 87, 175 |
| Ethernet | 14, 124, 148, 160, 161 |
| Europe | 167 |
| European customers | 11 |
| Exaggeration Factor | 36 |
| EXTERNAL ALARM | 159 |
| External Alarm | 105, 148 |
| External Amplifier | 158 |
| External Antenna | 96, 125, 127 |
| External bracket | 12 |
| F | |
| F-PRS | 175 |
| F-RATE | 175 |
| F-RATEA | 175 |
| F-RATEE | 175 |
| F-RATEIE | 175 |
| F-TRIP | 175 |
| Fahrenheit | 37 |
| Fathom | 176 |
| fathoms | 37 |
| Faulty | 169 |
| Favorites icon | 136 |
| favorites list | 136 |
| feet | 37, 176 |
| FF525 | 100, 105, 109, 148, 154, 155, 159, 165, 174, 176 |
| file | 83, 171 |
| FIND | 44, 45, 46, 47, 48, 50, 51, 52, 85 |
| Finnish | 35, 132 |
| Fish Finder | 12, 100, 109, 111, 124, 154, 155, 159, 160 |
| Fish Symbols | 165 |
| Fishing Facility | 70 |
| FLAC | 138 |
| Flick | 17 |
| Fluid level Black Water | 175 |
| Fluid level Fresh Water | 175 |
| Fluid level Fuel | 175 |
| flush mount | 145 |
| Flush Mount Bracket | 12 |
| Flush Mount Template | 12 |
| flush mounting | 147 |
| Flux Gate Compass | 97, 175 |
| focus | 86 |
| Forecast | 117, 119 |
| format the SD CARD | 82 |
| French | 35, 132 |
| Frequency | 165 |
| Fresh water | 11, 39 |
| FRONT PANEL | 15 |
| ft | 37, 176 |
| ftm | 37, 176 |
| Fuel | 37 |
| Fuel Pressure | 175 |
| Fuel Rate | 175 |
| Fuel Rate, Average | 175 |
| Fuel Rate, Economy | 175 |
| FULL 200kHz | 100 |
| FULL 4D | 42 |
| FULL 50kHz | 100 |
| Full Info | 49, 50, 60 |
| Full Screen View | 104 |

| | |
|----------------------------------|--|
| G | |
| GAGAN | 167 |
| GALILEO | 167 |
| General Setup | 29, 33, 34, 36, 37 |
| Geodetic Datum | 167 |
| German | 35, 132 |
| GGA | 110, 162, 163, 164, 167, 174 |
| GIF Decoder | 138 |
| GLL | 110, 162, 163, 164 |
| GMDS | 101, 174 |
| GNSS | 167 |
| GOTO A ROUTE | 76 |
| GOTO CURSOR | 75 |
| GOTO key | 15 |
| GOTO MARK | 77 |
| GPS | 11, 26, 32, 34, 87, 88, 94, 95, 96, 98, 108, 109, 125, 127, 144, 147, 148, 154, 159, 166, 167, 175 |
| GPS Setup Menu | 96 |
| GPS Status page | 26, 94, 95 |
| GPS2D | 96, 175 |
| GPS3D | 96, 175 |
| Great Lakes | 11, 21, 39 |
| Greek | 35, 132 |
| Greenwich Mean Time | 32 |
| Grounding Alarm | 105 |
| Grounding Alarm Range | 105 |
| Grounding Alarm Report | 106 |
| GSA | 110, 162, 164, 167 |
| GSV | 110, 162, 164, 167 |
| Guardian Alarm | 12, 39, 42 |
| GX2100 | 113, 155 |
| GX2150 | 113, 155 |
| H | |
| H.264 | 138 |
| Hawaii | 11, 21, 39 |
| HDC | 87, 110, 162, 163, 164, 175 |
| HDM | 162, 164 |
| HDOP | 87, 175 |
| HDT | 162, 164 |
| Heading | 87, 108, 175 |
| HEIGHT | 175 |
| HIGH BOOST PRESSURE | 106 |
| High Resolution Bathy Charts | 43 |
| HIGH WATER | 175 |
| Highway page | 30, 58, 76, 88, 94 |
| History list | 136 |
| Hold | 17 |
| Home Mode | 21, 26, 27, 38, 59, 76, 77, 88, 107 |
| HOME MODE REVERT | 38 |
| Home Mode Revert | 27, 76 |
| Horizontal Dilution of Precision | 87 |
| Hotspot | 121, 122, 123 |
| hPa | 37 |
| HSC | 110, 162, 163 |
| Hub | 124 |
| hue phase | 104 |
| Humidity | 117 |
| I | |
| Icons Size | 55 |
| IN/OUT Connections | 154 |
| India | 167 |
| Info Tree | 52 |
| Information | 44, 89 |
| information | 52 |
| Information window | 19 |
| INITIALIZING THE SD CARD | 82 |
| Input Current | 166 |
| Input Data Display | 169 |
| Input Data Format | 168 |

| | |
|----------------------------|---------------------------------------|
| Input Voltage | 166 |
| Input/Output | 109 |
| INSERTING A WAYPOINT | 69 |
| installation | 150 |
| Installation Package | 40, 170, 172, 173 |
| installation process | 41 |
| Instantaneous Fuel Economy | 175 |
| Intelligent key | 15, 16, 22, 23, 133, 139 |
| Interference Rejection | 165 |
| Internal Antenna | 96, 125, 127 |
| Internal Data Base Test | 169 |
| Internet Browser | 14, 16, 18, 22, 25, 136 |
| Internet navigation | 135 |
| Intertidal Areas | 70 |
| IP57 | 11 |
| ISO Certification | 41 |
| Italian | 35, 132 |
| J | |
| Japanese | 35, 132 |
| joystick | 21 |
| JPG Decoder (VPU+SW) | 138 |
| K | |
| keyboard | 11, 128, 129, 130, 131, 135, 162, 164 |
| KEYPAD BEEP | 37 |
| KEYS | 20 |
| kilometer | 37, 176 |
| kilometer per hour | 37, 176 |
| km | 37, 176 |
| km/h | 37, 176 |
| kn | 37, 176 |
| knots | 37, 176 |
| kPa | 37 |
| L | |
| Lake Info | 48, 49 |
| Lake name/info | 41 |
| Lakes | 44 |
| Lakes By Name | 50 |
| LAN | 162, 164 |
| Land Areas | 70 |
| Land Elevation | 42 |
| LANGUAGE | 38 |
| Language | 35, 57, 58 |
| Lat/Lon Grid | 91, 92 |
| Latitude/Longitude | 34, 51 |
| License page | 111 |
| Light Sectors | 91 |
| Lights | 58, 89, 91 |
| LINE COLOR | 80 |
| Line Out | 162, 164 |
| LOADING A FILE | 83 |
| Long press | 32 |
| Loop-Back Test | 169 |
| Loran TD | 34, 107 |
| Lost Target | 114 |
| LOW COOLANT LEVEL | 106 |
| LOW FUEL PRESSURE | 106 |
| LOW OIL LEVEL | 106 |
| LOW OIL PRESSURE | 106 |
| LOW SYSTEM VOLTAGE | 106 |
| LOW WATER | 175 |
| LVL-BW | 175 |
| LVL-FUEL | 175 |
| LVL-FW | 175 |
| M | |
| m | 37, 176 |
| m/s | 37 |
| Main Menu | 15, 20, 27, 30, 84 |
| MAINTENANCE NEEDED | 106 |
| MAN OVER BOARD | 77 |

| | |
|--|--|
| Man Over Board | 16, 22 |
| Marine Settings | 91 |
| Maritime Mobile Service Identity | 113 |
| Mark | 16, 21, 27, 51, 61, 62, 63, 64, 65, 68, 71, 77, 81, 94, 95, 162, 163, 168 |
| MARK key | 16 |
| Marks/Waypoints List | 21, 61, 63, 64, 77 |
| MAX | 41, 42 |
| Max Speed Log | 87, 176 |
| Maximum Depth | 165 |
| MEASURE DISTANCE | 38 |
| Media Player | 11, 14, 18, 23, 25, 137, 138, 139, 142, 143, 159 |
| Media Player Icon | 139 |
| memory stick | 11 |
| MENU DESCRIPTION | 18 |
| MENU key | 15 |
| meters | 37, 176 |
| Mexico | 11, 21, 39 |
| miles per hour | 37, 176 |
| Minimum Depth | 165 |
| MMSI | 102, 103, 113 |
| MOB | 22, 71, 77, 78, 114, 115, 116, 174 |
| MOB key | 16 |
| Monitor page | 99 |
| moon | 100 |
| Mooring/Warping Facility | 70 |
| mount the antenna | 147 |
| mouse | 128, 129, 131, 162, 164 |
| MOV | 138 |
| Move | 17 |
| MOVING A MARK | 62 |
| moving cursor | 17 |
| MP3 | 138 |
| MPEG-1 | 138 |
| MPEG-4 | 138 |
| mph | 37, 176 |
| MSAS | 167 |
| MTW | 110, 162, 163, 164 |
| Multilanguage | 35 |
| Multilanguage capability | 42 |
| Multimedia Player | 16 |
| MWD | 162, 164 |
| MWV | 162, 164 |
| N | |
| Name | 113 |
| name the Route | 66 |
| Nautical Mile | 37, 176 |
| Nav-Aids | 39, 42, 71, 91 |
| Nav-Aids & Light Sectors | 91 |
| Nav-Aids Names | 91 |
| Nav-Aids Presentation | 58 |
| Navigate | 34, 107 |
| Navigating a Route | 110 |
| NAVIGATION | 87, 88, 98 |
| Navigation | 30 |
| NAVIGATION PAGES | 94 |
| Navigation Speed | 96 |
| nearest Lakes | 48 |
| nearest Lakes By Name | 50 |
| nearest Obstructions | 48 |
| nearest Points Of Interest | 50 |
| nearest Port Services | 44 |
| nearest Ports | 46 |
| nearest Tide Stations | 46 |
| nearest Wrecks | 47 |
| Network | 11 |
| Networked Chart | 113 |
| NEUTRAL START PROTECT | 106 |
| Night | 34, 38 |
| Nm | 37, 176 |
| NMEA | 96, 97, 99, 124, 149, 154, 160, 174, 175 |
| NMEA Digital page | 96, 97 |
| NMEA Output | 167 |
| NMEA PAGES | 96 |
| NMEA-0183 | 11, 64, 70, 96, 97, 99, 101, 102, 108, 109, 110, 113, 148, 152, 154, 162, 163, 164 |
| NMEA-0183 Input sentences | 162, 164 |
| NMEA-0183 Output sentences | 154, 162, 163 |
| NMEA-2000 | 11, 96, 97, 99, 101, 102, 105, 108, 109, 113, 148, 161, 162, 164 |
| NMEA-2000 Input PGNs | 162, 164 |
| NMEA-2000 Output PGNs | 162, 164 |
| NOAA | 34, 38, 58 |
| Normal | 34, 35, 38 |
| North America | 12, 21, 26, 39, 44, 58, 93, 112, 113, 167 |
| North Up | 30, 58 |
| Norwegian | 35, 132 |
| NTSC | 12, 103, 157, 162, 164 |
| O | |
| O-TEMP | 175 |
| Object Info | 41 |
| Obstructions | 41, 44, 48, 70, 71, 91, 93 |
| Official data source | 41 |
| Ogg Vorbis | 138 |
| Oil/Boost Pressure | 37 |
| OLYMPIC ROUTE | 67 |
| Olympic Route | 12 |
| open a PDF file | 137 |
| Operating System | 170, 172, 173 |
| OPTIONAL ACCESSORIES | 13 |
| OS | 170 |
| Outdoor Recreational Area | 48 |
| Output sentences | 110 |
| OVER TEMPERATURE | 106 |
| Overlay | 53 |
| Overlay Mode | 54 |
| Owner's Manual | 12 |
| P | |
| PACKING LIST | 12 |
| Page Change Tab | 31 |
| Page Change tab | 24 |
| Page Icons | 84 |
| Page Selection | 84 |
| PAGE SWEEP | 37 |
| Page sweeping | 17 |
| Pages Selection | 30 |
| Pair | 34, 107 |
| PAL | 12, 103, 157, 162, 164 |
| Pan | 17, 26 |
| Panning | 119 |
| Parity | 169 |
| PART CODE | 12 |
| PC-Planner | 118 |
| PDF | 11, 137, 138, 139, 142, 143 |
| Perspective View | 42 |
| PGN | 162 |
| Photos & Diagrams | 42 |
| Physical Characteristics | 166 |
| Picture in Picture | 103, 104 |
| Pictures | 60 |
| PINGO | 175 |
| Pingos | 70 |
| PiP | 103, 104 |
| Place Names | 91 |
| Place Names Size | 55 |
| places a MOB | 22 |
| PLACING A MOB | 78 |

| | |
|------------------------------------|--|
| Playing music | 22 |
| Plotter Icon | 25, 128, 168 |
| PNG Decoder | 138 |
| POI | 41, 42, 50, 73 |
| Points Of Interest | 42, 44, 50 |
| Port | 42, 44, 46 |
| Port by Name | 41 |
| Port Icons | 89 |
| Port Info | 39, 41 |
| PORT Input | 154 |
| Port Names | 91 |
| PORT Output | 154 |
| Port Service | 44, 45, 73 |
| Port1 | 110, 169 |
| Port2 | 110, 154, 155, 169 |
| Port3 | 110, 169 |
| Port4 | 110, 169 |
| Ports & Services | 91 |
| Portuguese | 35, 132 |
| POS | 87 |
| Position | 87, 108 |
| Position Report | 12 |
| Position Request | 101, 102, 111, 175 |
| Power boat | 12, 30, 58 |
| Power Consumption | 162, 163 |
| Power Output | 165 |
| POWER REDUCTION | 106 |
| Power Supply | 162, 163 |
| POWER UP | 14 |
| POWERING OFF | 14 |
| Pre-Amp connector pin out | 158 |
| Pre-Amp Output | 158 |
| Production Installation | 70 |
| Programmed Date | 112 |
| Property Status | 112 |
| psi | 37 |
| PSK | 174, 175 |
| Puerto Rico | 11, 21, 39 |
| PWR ACC1 & ACC2 cable | 12 |
| PWR key | 14, 15, 16, 17, 22, 25, 40 |
| PWR/ACC1 | 149, 152, 154, 155 |
| Q | |
| Quick Info | 42, 49 |
| Quick Reference Guide | 12 |
| quick zoom | 21 |
| QuickTime | 138 |
| R | |
| Radio Call Sign | 113 |
| RAM | 81, 168 |
| RAM Clear | 168 |
| Raster | 16, 22 |
| Raster Chart | 11, 53, 54, 175 |
| RECEIVE | 64, 70 |
| Release Date | 112 |
| remove the SD CARD | 43, 44 |
| Remove-Favorite | 136 |
| replace an SD CARD | 24 |
| replacements parts | 12 |
| reset the Track | 80 |
| reset the Trip Log | 81 |
| Resolution | 162, 163 |
| RESPECT DRAUGHT | 73 |
| Restart GPS | 96 |
| REV LIMIT EXCEEDED | 106 |
| Reverses the Route | 70 |
| RMA | 110, 162, 163 |
| RMB | 110, 162, 163 |
| RMC | 110, 162, 163, 164, 167 |
| road mapping | 42 |
| Rocks | 70, 71, 91, 93 |
| rotary knob | 16, 22, 84 |
| ROTATE key | 16 |
| rotate the chart | 22 |
| Rotating | 36 |
| Route | 15, 27, 43, 61, 65, 66, 67, 68, 70, 71, 73, 74, 75, 76, 77, 81, 91, 94, 95, 110, 162, 163, 168 |
| Route Check | 12, 70, 71 |
| ROUTE key | 15 |
| ROUTE MENU | 69 |
| ROUTE WIDTH | 71 |
| RS232 | 154, 155 |
| RS422 | 154 |
| RTE | 64, 70, 162, 164 |
| RUDDER | 175 |
| Rudder Angle | 108, 175 |
| Russian | 35, 132 |
| S | |
| SAFE CORRIDOR | 73 |
| SAFE DEPTH | 72 |
| Safe Depth | 91, 92 |
| SAFE HEIGHT | 72 |
| SAFE MARGIN | 73 |
| safe navigation | 70 |
| Safe Route Check | 42 |
| Safely Remove Data Cartridge | 111 |
| Safety Status Bar | 42, 56, 93 |
| Sail boat | 12, 30, 58 |
| SART | 114, 115, 116, 174 |
| Satellite | 11, 16, 42, 53, 54 |
| satellite | 95, 96, 175 |
| saturation colors | 104 |
| save the file | 83 |
| SBAS | 167 |
| Scrolling maps | 17 |
| SD CARD | 16, 21, 24, 39, 43, 44, 60, 61, 65, 81, 82, 83, 92, 105, 112, 118, 139, 143, 162, 163, 169, 170, 172 |
| Seabed Type | 91 |
| Search & Find | 41 |
| Second CPN | 96 |
| Segmentation | 113 |
| select a page | 28 |
| select a Route | 76 |
| SELECTING AN ITEM | 20 |
| Selecting Language | 35 |
| SEND | 64, 70 |
| SERIAL PORTS | 169 |
| Setup Menu | 27, 28 |
| Shallow Water | 70, 71, 165 |
| Ship Icon | 12, 26, 29, 58, 59 |
| Shoreline Constructions | 70 |
| show Soft Keys | 24 |
| Shut Down | 14, 22, 126, 127 |
| SHUTTLE POINT ENTER | 37 |
| ShuttlePoint knob | 16, 21, 37, 84 |
| Signals | 58, 91 |
| Simulation Mode | 110 |
| Single Chart | 52, 86 |
| Single tap | 26, 31 |
| Sleeping Target | 114 |
| slot | 40, 118 |
| SM | 37, 176 |
| SOFT KEYS | 23 |
| Soft Keys | 32 |
| SOG | 85, 87, 96, 108, 110, 175, 176 |
| Spanish | 35, 132 |
| SPD | 87, 175 |
| SPECIFICATIONS | 162 |
| Speed | 37, 79, 108, 110, 124, 165, 175 |
| Speed Filter | 96 |
| Speed Log | 97 |

| | |
|---|---------------------------------------|
| Speed Over Ground | 87, 175 |
| Speed Through Water | 87, 108 |
| Splash Screen | 14, 25, 168 |
| Spot Soundings | 39, 43 |
| START EASY ROUTING | 73 |
| start navigation | 21, 78 |
| Starting music | 23 |
| Startup Screen | 14, 16, 25, |
| 41, 120, 125, 126, 129, 132, 138, 139, 168, 171 | |
| Static Navigation | 107 |
| Statute Mile | 37, 176 |
| STC | 165 |
| Steer | 175 |
| Steering Angle | 87 |
| STEP UNIT | 79, 80 |
| stop navigation | 21, 76, 78 |
| Stopping music | 23 |
| STR | 87, 175 |
| SUB OR SECONDARY THROTTLE | 106 |
| SunLight | 34, 35, 38 |
| Sunlight viewable | 11, 162, 163 |
| surface | 16 |
| SVGA | 11, 163 |
| Swedish | 35, 132 |
| Sweep | 31 |
| Swipe | 26 |
| System Alarm Report | 106 |
| System Test | 168 |
| SYSTEM UPDATE | 170 |
| T | |
| TANK | 98 |
| Tap | 17 |
| Target | 113 |
| Targets AIS | 12 |
| TCPA | 113 |
| TCPA Alarm | 113, 114 |
| TCPA Limit | 113, 114 |
| TD | 34, 107 |
| Technical support | 11 |
| Temperature | 37, 124 |
| temperature | 162, 163 |
| Temperature Sensor | 165 |
| template | 145, 146, 147 |
| TERMS | 174 |
| THICKNESS | 70 |
| THROTTLE POSITION SENSOR | 106 |
| Thumb Drive | 159 |
| Tide Height | 175 |
| Tide page | 33, 39, 100 |
| Tide Station | 41, 42, 44, 46, 89, 101 |
| Tides | 90, 91, 100 |
| Tides & Currents | 91 |
| Tides Preview | 42 |
| TILT key | 16 |
| tilt the chart | 22 |
| Tilting | 36 |
| TIME | 79, 80, 87, 175 |
| Time | 79, 80, 108, 110 |
| Time Coordinates | 32 |
| Time Format | 37 |
| TIME SETUP | 37 |
| Time Setup | 32, 33, 47 |
| Time to Closest Point of Approach | 113 |
| Time To Go | 87, 175 |
| Time Zone | 32, 37 |
| TIMEOUT | 73 |
| TKIP | 175, 176 |
| TLL | 162, 164 |
| TLOG | 80, 81, 87, 175 |
| Touchscreen | 14, 15, 16, 17, 22, 162 |
| Touchscreen Calibration | 16, 21, 22 |
| Touchscreen Disabling | 17, 22 |
| Touchscreen Keyboard | 18, 135 |
| Touchscreen Keys | 17 |
| Towers | 89 |
| Track | 78, 79, 80, 81, 85, 162, 163, 168 |
| Track Menu | 80 |
| Track Points | 78, 79, 80, 162, 163 |
| TRACKING | 80 |
| Tracks & Routes | 91 |
| transducer | 124, 165 |
| Transparency | 36, 54 |
| Trip Fuel Used | 175 |
| Trip Log | 80, 81, 87, 165, 175 |
| TRK | 87 |
| True Wind Direction | 87, 175 |
| True Wind Speed | 87, 175 |
| True-Type Font | 42 |
| TTG | 87, 175 |
| TWD | 87, 175 |
| TWS | 87, 175 |
| TXT | 167 |
| U | |
| UK customers | 11, 12 |
| UK gal | 37 |
| Underwater Ob. Limit | 91 |
| Underwater Object Limit | 93 |
| Underwater Objects Settings | 93 |
| UNIT ID | 39, 40 |
| UNITS | 37, 176 |
| Universal Transverse Mercator Grid | 107 |
| update software | 16 |
| Updating Built-In Charts | 39 |
| URL | 18, 135 |
| US gal | 37 |
| USA customers | 11 |
| USB | 11, 24, 162, 164 |
| USB memory stick | 148 |
| USB Thumb Drive | 139, 143, 159 |
| User Point | 44, 51, 61, |
| 64, 73, 76, 81, 82, 83, 162, 163 | |
| User Points List | 63 |
| USER SD CARD | 81 |
| UTC | 32 |
| UTM | 34, 107 |
| V | |
| VAD | 43, 70, 91, 92, 93, 105 |
| VAD Boundaries | 91, 93 |
| Value Added Data | 11, 41, 43, 93 |
| VARIATION | 108 |
| Variation | 108 |
| VDM | 113, 162, 164 |
| VDOP | 87, 175 |
| Vector | 16, 22, 26, 53, 54, 119 |
| Vector Chart Sharing | 124, 125, 127 |
| Vector-based Chart | 176 |
| Vector/Sat | 16 |
| Vector/Satellite | 22 |
| VEL | 87, 176 |
| Velocity Made Good | 87 |
| Vertical Dilution of Precision | 87 |
| VGA | 11, 148, 157, 158, 162, 164 |
| VGAC10 adapter cable | 157 |
| VHF | 12, 101, 113, 148, 154, 155, 174, 175 |
| VHW | 110, 162, 163, 164 |
| Video adjustment mode | 104 |
| Video Camera | 148 |
| video default settings | 104 |
| Video Input | 12, 103, 104, 157, 162, 164 |
| VIDEO INPUT CONNECTIONS | 157 |

| | |
|--------------------------|---|
| Video Output | 164 |
| video source | 157 |
| Visibility | 117 |
| VISIBLE | 80 |
| VMA8 | 138 |
| VMA9 | 138 |
| VMG | 87, 176 |
| VTG | 110, 162, 163, 164 |
| VTs | 113 |
| VWR | 162, 164 |
| VWT | 162, 164 |
| W | |
| W-T | 87, 176 |
| WAAS | 11, 95, 96, 109, 147, 154, 166, 167, 176 |
| WAAS/EGNOS Setting | 96 |
| Warning | 150 |
| Warning Icon | 56 |
| WARNING LEVEL 1 | 106 |
| WARNING LEVEL 2 | 106 |
| Warning Messages | 74 |
| Warning page | 25, 26 |
| Warning Status | 113 |
| Warning window | 19, 76, 78, 81 |
| WATER FLOW | 106 |
| WATER IN FUEL | 106 |
| Water Temperature | 79, 87, 108, 176 |
| waterproof | 11 |
| Wave | 138 |
| Wave Direction | 117 |
| Wave Height | 117 |
| Waypoint | 15, 21, 43, 51, 61, 62, 63, 64, 65, 66, 67, 68, 69, 70, 71, 77, 81, 94, 162, 163, 175 |
| WCV | 110, 162, 163 |
| Weather | 12 |
| Weather Forecasts | 117 |
| Weather page | 117 |

| | |
|------------------------------------|--|
| Weight | 162, 163, 166 |
| WEP | 123, 176 |
| WGS 1984 | 107 |
| WGS84 | 167 |
| White Line | 165 |
| Wi-Fi® | 11, 14, 117, 118, 120, 121, 122, 133, 162, 164 |
| Wi-Fi® Alliance | 121 |
| Wide SVGA | 163 |
| Wind | 108 |
| Wind Direction | 117 |
| Wind Speed | 37, 97, 117 |
| Windows® XP Operating System | 143 |
| Wired Equivalent Privacy | 176 |
| Worldwide Background | 169 |
| WPA™ | 176 |
| WPA™-Personal | 176 |
| WPA-PSK | 123 |
| WPA2™ | 176 |
| WPA2-PSK | 123 |
| WPL | 64, 162, 164 |
| Wrecks | 41, 42, 44, 47, 70, 89, 91, 93 |

X

| | |
|-----------------|-----------------------------|
| XTE | 87, 105, 110, 162, 163, 176 |
| XTE Alarm | 105 |
| Xvid | 138 |

Z

| | |
|------------------------|---------------|
| Zetakey™ Browser | 11, 132, 137 |
| Zoom | 100, 119, 165 |
| zoom | 21 |
| ZOOM 200kHz | 100 |
| ZOOM 50kHz | 100 |
| ZOOM key | 16 |
| Zooming | 36 |

PLEASE NOTE

United States: To receive warranty service, the purchaser must deliver the Product, transportation and Insurance prepaid, to STANDARD HORIZON (Marine Division of YAESU USA) - Attention Factory Service - 6125 Phyllis Drive - Cypress, CA 90630, include proof of purchase indicating model, serial number and date of purchase. This warranty only extends to Products sold within the 50 States of the United States of America and the District of Columbia.

Europe: Contact details for warranty in Europe are available from the dealer in your country or from www.standardhorizon.co.uk where details of warranty terms and contact details for Europe can be obtained.

For Limited Warranty details outside United States and Europe, contact the dealer in your country.

STANDARD HORIZON LIMITED WARRANTY

STANDARD HORIZON (the Marine Division of YAESU USA) warrants, to the original purchaser only, each new Marine Product ("Product") manufactured and/or supplied by STANDARD HORIZON against defects in materials and workmanship under normal use and service for a period of 3 years from the date of purchase.

In the event of a defect, malfunction or failure of the Product during the warranty period, STANDARD HORIZON's liability for any breach of contract or any breach of express or implied warranties in connection with the sale of Products shall be limited solely to repair or replacement, at its option, of the Product or part(s) therein which, upon examination by STANDARD HORIZON, appear to be defective or not up to factory specifications. STANDARD HORIZON may, at its option, repair or replace parts or subassemblies with new or reconditioned parts and subassemblies.

STANDARD HORIZON will not warrant installation, maintenance or service of the Products. In all instances, STANDARD HORIZON's liability for damages shall not exceed the purchase price of the defective Product.

STANDARD HORIZON will pay all labor and replacement parts charges incurred in providing the warranty repair service except where purchaser abuse or other qualifying exceptions exist. The purchaser must pay any transportation expenses incurred in returning the Product to STANDARD HORIZON for service.

This limited warranty does not extend to any Product which has been subjected to misuse, neglect, accident, incorrect wiring by anyone other than STANDARD HORIZON, improper installation, or subjected to use in violation of instructions furnished by STANDARD HORIZON, nor does this warranty extend to Products on which the serial number has been removed, defaced, or changed. STANDARD HORIZON cannot be responsible in any way for ancillary equipment not furnished by STANDARD HORIZON which is attached to or used in connection with Products, or for the operation of the Product with any ancillary equipment, and all such equipment is expressly excluded from this warranty. STANDARD HORIZON disclaims liability for range, coverage, or operation of the Product and ancillary equipment as a whole under this warranty.

STANDARD HORIZON reserves the right to make changes or improvements in Products, during subsequent production, without incurring the obligation to install such changes or improvements on previously manufactured Products. The implied warranties which the law imposes on the sale of this Product are expressly LIMITED, in duration, to the time period specified above. STANDARD HORIZON shall not be liable under any circumstances for consequential damages resulting from the use and operation of this Product, or from the breach of this LIMITED WARRANTY, any implied warranties, or any contract with STANDARD HORIZON. IN CONNECTION WITH THE SALE OF ITS PRODUCTS, STANDARD HORIZON MAKES NO WARRANTIES, EXPRESS OR IMPLIED AS TO THE MERCHANTABILITY OR FITNESS FOR A PARTICULAR PURPOSE OR OTHERWISE, EXCEPT AS EXPRESSLY SET FORTH HEREIN.

Some Countries in Europe and States of the USA do not allow the exclusion or limitation of incidental or consequential damages, or limitation on how an implied warranty lasts, so the above limitation or exclusions may not apply. This warranty provides specific rights, there may be other rights available which may vary between countries in Europe or from state to state within the USA.

Declaration of Conformity

Nr. YUK-DOC-1101-11

We, Yaesu UK Ltd. certify and declare under our sole responsibility that the following equipment complies with the essential requirements of the Directive 1999/5/EC, with the provisions of Annex III (Conformity Assessment procedure referred to in article 10)

| | |
|--------------------------|--|
| Type of Equipment: | Chart Plotter for Marine Navigation with internal GPS receiver |
| Brand Name: | Standard Horizon |
| Model Number | CPN700i |
| Manufacturer | TWS S.r.l |
| Address of Manufacturer: | Via Zaccagna 6, 54033 Carrara Italy |

Applicable Standards:

This equipment is tested to and conforms to the essential requirements of directive, as included in following standards:

| Test | Standard |
|---|--|
| Conducted Emissions | IEC EN 60945:2002 |
| Radiated Emissions | ETSI EN 301 489-1 V1.8.1 |
| Radiated interference | ETSI EN 301 489-17 V2.1.1 |
| Radiated RF immunity | |
| Receiver requirements | ETSI EN 300 328 V1.7.1 |
| Electrostatic Discharge ESD | IEC EN 60945:2002 |
| Conducted RF interference | ETSI EN 301 489-1 V1.8.1 |
| Conducted RF immunity | ETSI EN 301 489-17 V2.1.1 |
| Compass Safe Distance | IEC EN 60945:2002 ISO/R 694 |
| EFT – Bursts Fast Transients | IEC EN 60945:2002 ETSI EN 301 489-1 V1.8.1 ETSI EN 301 489-17 V2.1.1 |
| DC Power Interruptions, Variation and Polarity inversions | IEC EN 60945:2002 ETSI EN 301 489-1 V1.8.1 ETSI EN 301 489-17 V2.1.1 |
| Safety: Part 1 General Requirements | IEC EN 60950-1:2006/A1:2010 |

The technical documentation as required by the Conformity Assessment procedures is kept at the following address:

Company: Yaesu UK Ltd
Address: Unit 12, Sun Valley Business Park,
Winnall Close, Winchester SO23 0LB

Technical Construction File: Issued by Yaesu Musen Co., Ltd., Tokyo, Japan
File No: UK7001111

Drawn up in: Winchester, United Kingdom
Date: 26th January 2012



Name and position: PCJ Bigwood,
Technical Sales Manager

YAESU

STANDARD HORIZON

Yaesu UK Ltd
 Unit 12, Sun Valley Business Park
 Winnall Close
 Winchester SO23 0LB
 United Kingdom
 Tel: +44 (0)1962 866667
 Fax: +44 (0)1962 856801
 Email: sales@yaesu.co.uk

Declaration of Conformity

Nr. YUK-DOC-1102-11

We, Yaesu UK Ltd. certify and declare under our sole responsibility that the following equipment complies with the essential requirements of the Directive 1999/5/EC, with the provisions of Annex III (Conformity Assessment procedure referred to in article 10)

| | |
|--------------------------|--|
| Type of Equipment: | Chart Plotter for Marine Navigation with internal GPS receiver |
| Brand Name: | Standard Horizon |
| Model Number | CPN1010i |
| Manufacturer | TWS S.r.l |
| Address of Manufacturer: | Via Zaccagna 6, 54033 Carrara Italy |

Applicable Standards:

This equipment is tested to and conforms to the essential requirements of directive, as included in following standards:

| Test | Standard |
|---|--|
| Conducted Emissions | IEC EN 60945:2002 |
| Radiated Emissions | ETSI EN 301 489-1 V1.8.1 |
| Radiated interference | ETSI EN 301 489-17 V2.1.1 |
| Radiated RF immunity | |
| Receiver requirements | ETSI EN 300 328 V1.7.1 |
| Electrostatic Discharge ESD | IEC EN 60945:2002 |
| Conducted RF interference | ETSI EN 301 489-1 V1.8.1 |
| Conducted RF immunity | ETSI EN 301 489-17 V2.1.1 |
| Compass Safe Distance | IEC EN 60945:2002 ISO/R 694 |
| EFT – Bursts Fast Transients | IEC EN 60945:2002 ETSI EN 301 489-1 V1.8.1 ETSI EN 301 489-17 V2.1.1 |
| DC Power Interruptions, Variation and Polarity inversions | IEC EN 60945:2002 ETSI EN 301 489-1 V1.8.1 ETSI EN 301 489-17 V2.1.1 |
| Safety: Part 1 General Requirements | EN 60950-1:2006/A1:2010 |

The technical documentation as required by the Conformity Assessment procedures is kept at the following address:

Company: Yaesu UK Ltd
 Address: Unit 12, Sun Valley Business Park,
 Winnall Close, Winchester SO23 0LB

Technical Construction File: Issued by Yaesu Musen Co., Ltd., Tokyo, Japan
 File No: UK10101111

Drawn up in:
 Date:

Winchester, United Kingdom
 26th January 2012



Name and position:

PCJ Bigwood,
 Technical Sales Manager