

STANDARD HORIZON

MATRIX SERIES GX2000 and GX2150

25 Watt VHF/FM

Marine Transceivers

Owner's Manual

- Integrated dual channel AIS (Automatic Identification System) receiver (GX2150)
- AIS (Automatic Identification System) receiver or transponder connection (GX2000)
- 4800 or 38400 NMEA baud rate selection for plotters with 1 NMEA port (GX2150)
- Able to use PA or Fog signaling when on AIS display (GX2150)
- True and Magnetic bearing selection on AIS display*
- AIS target display: MMSI, Call Sign, Ship Name, BRG, DST, SOG and COG*
- Contact Class A or B AIS Ship with DSC*
- Programmable CPA or TCPA collision avoidance alarms*
- ITU Class D DSC (Independent Channel 70 receiver built-in)
- 80dB Commercial grade receiver
- DSC position request and report functions*
- Navigate to a DSC Distress Call*
- 30 Watt PA/Loud Hailer with pre-programmed fog signals and (listen back GX2150)
- ClearVoice noise canceling speaker microphone with channel selection and 16/9 key
- GPS Compass, Waypoint and GPS status pages*
- Navigation (LAT/LON, Time, SOG and COG) information shown on display*
- Enter, Save and Navigate to waypoints with Compass page*
- User programmable soft keys
- Versatile user-programmable scanning, priority scan and Dual Watch
- Oversized rotary channel knob with push to enter, backlit display and keys
- Optional connection for RAM3 second station remote microphone with AIS display
- Intercom between radio and RAM3
- Voice Scrambler (optional)
- Local/Distance attenuator
- Submersible JIS-7 / IPX7 (3.3 feet for 30 minutes)
- E2O (Easy-To-Operate) menu system

* When connected to a GPS



MATRIX AIS+ GX2150



MATRIX GX2000

TABLE OF CONTENTS

Quick Reference Guide	4	9 DIGITAL SELECTIVE CALLING	42
1 GENERAL INFORMATION	5	9.1 GENERAL	42
2 PACKING LIST	6	9.2 MARITIME MOBILE SERVICE IDENTITY (MMSI)	42
3 OPTIONS	6	9.2.1 What is an MMSI?	42
4 ON-LINE WARRANTY REGISTRATION (in USA or Canada only)	6	9.2.2 Programming the MMSI	43
5 GETTING STARTED	7	9.3 DSC DISTRESS ALERT	44
5.1 PROHIBITED COMMUNICATIONS	7	9.3.1 Transmitting a DSC Distress Alert	44
5.2 ABOUT VHF RADIO	7	9.3.1.1 Transmitting a DSC Distress Alert with Nature of Distress	45
5.3 SELECTING AN ANTENNA	7	9.3.1.2 Transmitting a DSC Distress Alert by Manually Entering a Position	45
5.4 COAXIAL CABLE	8	9.3.1.3 Pausing a DSC Distress Call	47
5.5 DISTRESS AND HAILING (CHANNEL 16 USE)	8	9.3.1.4 Cancel a DSC Distress Call	47
5.6 CALLING ANOTHER VESSEL (CHANNEL 16 OR 9)	9	9.3.2 Receiving a DSC Distress Call	47
5.7 MAKING TELEPHONE CALLS	10	9.3.2 a. ACCEPT	47
5.8 BRIDGE CHANNELS 13 AND 67	10	9.3.2 b. PAUSE	47
5.9 AUTOMATED RADIO CHECK SERVICE	10	9.3.2 c. QUIT	47
5.10 WHAT IS THE RANGE FOR AIS RECEIVERS?	11	9.4 ALL SHIPS CALL	49
6 INSTALLATION	12	9.4.1 Transmitting an All Ships Call	49
6.1 SAFETY / WARNING INFORMATION	12	9.4.2 Receiving an All Ships Call	50
6.2 LOCATION	12	9.5 INDIVIDUAL CALL	51
6.3 MOUNTING THE RADIO	13	9.5.1 Individual / Position Call Directory Setup	51
6.3.1 Supplied Mounting Bracket	13	9.5.2 Individual Reply Setup	52
6.3.2 Optional MMB-84 Flush Mount Bracket	13	9.5.3 Individual Acknowledgment Setup	52
6.4 ELECTRICAL CONNECTIONS	14	9.5.4 Individual / Group Call Ringer Setup	53
6.5 ACCESSORY CABLES	15	9.5.5 Transmitting an Individual Call	54
6.5.1 MATRIX GX2000 Connection	15	9.5.5.1 Individual Call using the Individual Directory	54
6.6 MATRIX AIS+ CONNECTIONS	16	9.5.5.2 Individual Call by Manually Entering a MMSI	55
6.6.1 MATRIX AIS+ 4800 Baud Connections	16	9.5.5 Receiving an Individual Call	56
6.6.2 MATRIX AIS+ 38400 Baud Connections	17	9.6 DSC LOG OPERATION	57
6.7 CHECKING GPS CONNECTIONS	19	9.6.1 Reviewing a Logged DSC Distress Call	57
6.8 CHANGING THE GPS TIME	19	9.6.2 Reviewing a Logged All Ship or Individual Call	58
6.9 CHANGING THE TIME AREA	20	9.6.3 Deleting a Call from the "DSC LOG" Directory	59
6.10 CHANGING THE TIME DISPLAY	20	9.7 GROUP CALL	60
6.11 CHANGING COG TO TRUE OR MAGNETIC	21	9.7.1 Group Call Setup	60
6.12 OPTIONAL RAM3 (CMP30) INSTALLATION	21	9.7.2 Transmitting a Group Call	61
6.12.1 Connecting an External Speaker to the RAM3 Mic Cable	23	9.7.2.1 Group Call using the Individual Directory	61
6.12.2 External Speaker AF Selection	23	9.7.2.2 Group Call by Manually Entering a MMSI	62
7 CONTROLS AND INDICATORS	24	9.7.3 Receiving a Group Call	63
7.1 FRONT PANEL	24	9.8 POSITION REQUEST	64
7.2 REAR PANEL	26	9.8.1 Position Reply Setup	64
7.3 MICROPHONE	28	9.8.2 Position Request Ringer Setup	65
8 BASIC OPERATION	30	9.8.3 Transmitting a Position Request to Another Vessel	65
8.1 RECEPTION	30	9.8.3.1 Position Request using the Individual Directory	65
8.2 TRANSMISSION	30	9.8.3.2 Position Request by Manually Entering a MMSI	66
8.3 TRANSMIT TIME-OUT TIMER (TOT)	30	9.8.4 Receiving a Position Request	66
8.4 SIMPLEX / DUPLEX CHANNEL USE	31	9.9 POSITION REPORT	68
8.5 DISPLAY TYPE	31	9.9.1 Position Report Ringer Setup	68
8.6 USA, CANADA, AND INTERNATIONAL MODE	32	9.9.2 Transmitting a DSC Position Report Call	68
8.7 NOAA WEATHER CHANNELS	32	9.9.2.1 DSC Position Report Call using the Individual Directory	68
8.7.1 NOAA Weather Alert	32	9.9.2.2 DSC Position Report Call by Manually Entering a MMSI	69
8.7.2 NOAA Weather Alert Testing	33	9.9.3 Receiving a DSC Position Report Call	70
8.8 DUAL WATCH (TO CHANNEL16)	33	9.9.4 Navigating to a Position Report	70
8.9 PRESET CHANNELS (0 - 9): INSTANT ACCESS	34	9.9.5 Stop Navigating to Position Report	70
8.9.1 Preset Channel Programming	34	9.9.6 Saving a Position Report Call as a Waypoint	71
8.9.2 Operation	34	9.9.7 Navigating to a Saved Waypoint	71
8.9.3 Deleting a Preset Channel	34	9.10 MANUAL INPUTTING A GPS POSITION (LAT/LON)	72
8.10 SCANNING	35	9.11 AUTO DSC POLLING	73
8.10.1 Scan Type Selection	35	9.11.1 Polling Time Interval Setup	73
8.10.2 Scan Memory Programming	36	9.11.2 Selecting Stations to be Automatically Polled (tracked)	73
8.10.3 Memory Scanning (M-SCAN)	36	9.11.3 Enable/Disable Auto DSC Polling	74
8.10.4 Priority Scanning (P-SCAN)	36	9.12 DSC TEST	75
8.11 PA / FOG OPERATION	37	9.12.1 Programming MMSI into Individual Directory	75
8.11.1 PA HAIL Operation	37	9.12.2 DSC Test Call by using the Individual Directory	75
8.11.2 FOG HORN Operation	38	9.12.3 DSC Test Call by Manually Entering a MMSI	76
8.11.3 Fog Signal Timing Chart	39		
8.12 INTERCOM OPERATION	40		
8.12.1 Communication	40		
8.12.2 Calling	40		
8.13 VOICE SCRAMBLER	41		

TABLE OF CONTENTS

10 GENERAL SETUP	77	14 WAYPOINTS	102
10.1 DISPLAY	77	14.1 MARKING A POSITION	102
10.2 LOCAL DISTANCE RECEIVER ATTENUATOR	78	14.2 ADDING A WAYPOINT	103
10.3 DIMMER ADJUSTING	79	14.3 EDITING A WAYPOINT	104
10.4 CONTRAST	79	14.4 DELETING A WAYPOINT	104
10.5 TIME OFFSET	80	14.5 SAVING A DSC POSITION CALL AS A WAYPOINT	105
10.6 TIME AREA	81	14.6 NAVIGATING TO A SAVED WAYPOINT	105
10.7 TIME DISPLAY	81	14.7 STOP NAVIGATING TO A WAYPOINT	106
10.8 UNIT OF MEASURE	82	15 RAM3 (CMP30) REMOTE MIC OPERATION	108
10.9 MAGNETIC	82	15.1 REMOTE MIC CONTROLS	108
10.10 NMEA DATA IN / OUT	83	15.2 ASSIGNING SOFT KEYS	110
10.11 KEY BEEP	83	16 MAINTENANCE	112
10.12 FOG ALERT TONE FREQUENCY	84	16.1 REPLACEMENT PARTS	112
10.13 STATION NAME	85	16.2 FACTORY SERVICE	112
10.14 SOFT KEYS	86	16.3 TROUBLESHOOTING CHART	113
10.14.1 Selecting the Number of Soft Keys	86	17 CHANNEL ASSIGNMENTS	114
10.14.2 Assigning Soft Keys	86	18 WARRANTY	120
10.14.3 Selecting How Long the Soft Keys are Shown	87	19 RESET PROCEDURES	123
11 CHANNEL FUNCTION SETUP	88	19.1 MEMORY CLEAR	123
11.1 CHANNEL GROUP	88	19.2 MICROPROCESSOR RESETTING	123
(USA, CANADA or INTERNATIONAL BAND SELECTION)	88	20 SPECIFICATIONS	124
11.2 SCAN MEMORY	88	20.1 GENERAL	124
11.3 SCAN TYPE	89	20.2 TRANSMITTER	124
11.4 SCAN RESUME	89	20.3 RECEIVER (for Voice and DSC)	125
11.5 PRIORITY CHANNEL	90	20.4 RECEIVER (for AIS)	125
11.6 WEATHER ALERT	90	20.5 NMEA INPUT OUTPUT	125
11.7 CHANNEL NAME	91	20.6 DIMENSIONS	126
11.8 SCRAMBLER SETUP	92	21 FCC RADIO LICENSE INFORMATION	127
11.9 DEMO MODE	93	21.1 STATION LICENSE	127
12 DSC SETUP	94	21.2 RADIO CALL SIGN	127
12.1 INDIVIDUAL DIRECTORY	94	21.3 CANADIAN SHIP STATION LICENSING	127
12.2 INDIVIDUAL REPLY	94	21.4 FCC / INDUSTRY CANADA INFORMATION	127
12.3 INDIVIDUAL ACKNOWLEDGMENT	94	21 FCC NOTICE	1280
12.4 INDIVIDUAL RINGER	94		
12.5 GROUP DIRECTORY	94		
12.6 POSITION REPLY	95		
12.7 AUTO POSITION INTERVAL	95		
12.8 DSC BEEP	95		
13 AIS/COMPASS SETUP	96		
13.1 AUTOMATIC IDENTIFICATION SYSTEM (AIS)	96		
13.2 DIRECTION	97		
13.3 ACTIVATION RANGE	97		
13.4 CPA ALERT	98		
13.5 TCPA ALERT	98		
13.6 DISPLAY RANGE	99		
13.7 AIS Operation	100		
13.7.1 Transmitting and Individual Call to an AIS Ship	101		
13.7.2 AIS Range	101		

QUICK REFERENCE GUIDE

This transceiver is equipped with the E2O (Easy-To-Operate) system. Basic operation may be accomplished by following the procedure below:

- ① Press and hold the **PWR▼/VOL** knob to turn on or off the radio.
- ② Rotate the **PWR▼/VOL** knob to adjust the speaker audio volume.
- ③ Rotate the **CHANNEL** knob (or press the microphones ▼ / ▲ button) to select the operating channel.
- ④ Move the **SQL** knob clockwise to squelch or counter clockwise un-squelch the radio.
- ⑤ Press the **H/L** button to toggle the transmit power between High (25W) and Low (1W).
- ⑥ Press the **16** button on the radio or the mic to select channel 16. Press and hold the **16** button on the radio or the mic to select channel 9. Press again to revert to the last selected channel.
- ⑦ To transmit: place your mouth about 1/2 inch away from Mic hole and speak in a normal voice level while pressing the **PTT** switch.

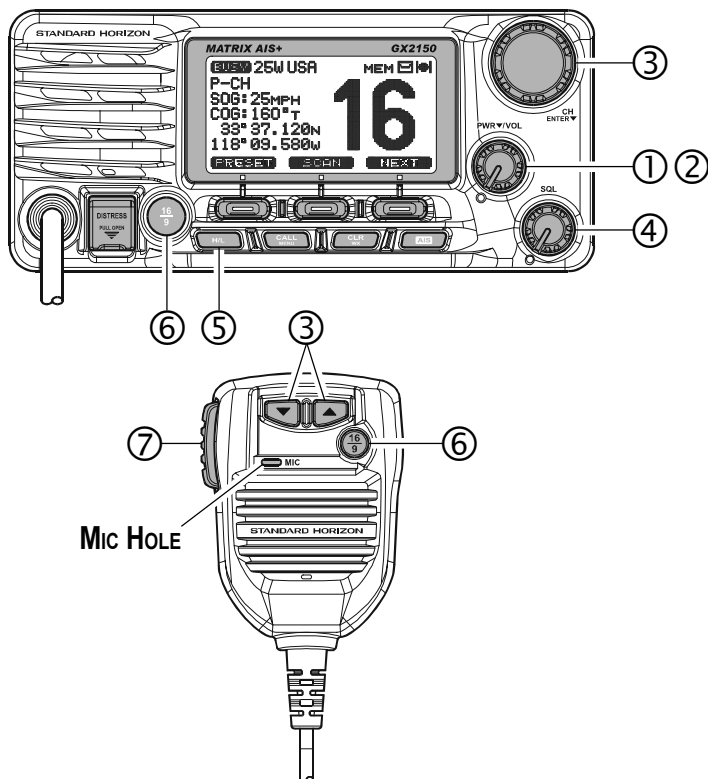

1 GENERAL INFORMATION



The STANDARD HORIZON MATRIX Series **GX2000** and **GX2150** Marine VHF/FM Marine Transceivers are designed to be used in USA, International and Canadian Marine bands. The **GX2000** and **GX2150** can be operated from 11 to 16 VDC and has a switchable RF output power of 1 watt or 25 watts.

MATRIX AIS+ GX2150

Integrates a dual channel AIS (Automatic Identification System) receiver to display AIS vessel information (MMSI, Call Sign, Ship Name, BRG, DST, SOG and COG) directly on the VHF radio, so you will know what is out there in any conditions. The **GX2150** is also capable of entering and saving up to 100 waypoints, which may be selected and navigated to by using a unique navigation compass display. The MATRIX AIS+ allows you to contact an AIS Ship directly using DSC, show your vessels position in relation to AIS targets and alert you when an AIS ship may be approaching too close to your location via the Closest Point of Approach (CPA) Alarm. To receive and display AIS targets from ships with AIS class A or B transponders, simply connect the normal VHF antenna (only one antenna needed!) and a GPS with NMEA 0183 output.

MATRIX - GX2000

For the mariner who already has AIS on-board and desires a VHF with the features of the MATRIX AIS, the MATRIX **GX2000** has a connection for an AIS receiver or transponder.

The MATRIX Series VHF's are capable of DSC (Digital Selective Calling) ITU Class D operation. Class D operation allows continuous receiving of Digital Selective Calling functions on channel 70 even if the radio is receiving a call. The MATRIX Series VHF's operate on all currently-allocated marine channels which are switchable for use with USA, International, or Canadian regulations. Emergency channel 16 can be immediately selected from any channel by pressing the red  key. NOAA Weather channels can also be accessed immediately by pressing and holding the  key.

Other features of the MATRIX Series VHF's include: Speaker Microphone, 30W PA/Fog, optional **RAM3** second station remote-control microphone with AIS display, intercom between radio and optional **RAM3**, scanning, priority scanning, submersible speaker mic, high and low voltage warning, and GPS repeatability.

2 PACKING LIST

When the package containing the transceiver is first opened, please check it for the following contents:

- **GX2000** or **GX2150** Transceiver
- Mounting Bracket and hardware
- Owner's Manual
- DSC Warning Sticker
- Flush Mount Template
- Power Cord
- Dust Cover

3 OPTIONS

MMB-84	Flush-Mount Bracket
RAM3B/W	Remote-Access Microphone (CMP30Black/White)
HC2000	Dust Cover
CT-100	23-foot Extension Cable for RAM3 Mic
CVS2500	Voice Scrambler
MLS-310	10W amplified External Speaker with on/off Volume control
MLS-300	External Loud Speaker
220SW	4.5" Round Hail/PA Horn
240SW	5" x 8" Rectangular Hail/PA Horn

4 ON-LINE WARRANTY REGISTRATION (in USA or Canada only)

Please visit www.standardhorizon.com to register the **GX2000/GX2150** Marine VHF. It should be noted that visiting the Web site from time to time may be beneficial to you, as new products are released they will appear on the STANDARD HORIZON Web site.

PRODUCT SUPPORT INQUIRIES

If you have any questions or comments regarding the use of the **GX2000/GX2150**, you can visit the STANDARD HORIZON Web site to send an E-Mail or contact the Product Support team at (800) 767-2450 M-F 7:00-5:00PST.

5 GETTING STARTED

5.1 PROHIBITED COMMUNICATIONS

The FCC prohibits the following communications:

- False distress or emergency messages;
- Messages to “any boat” except in emergencies and radio tests;
- Messages to or from a vessel on land;
- Transmission while on land;
- Obscene, indecent, or profane language (potential fine of \$10,000).

5.2 ABOUT VHF RADIO

The radio frequencies used in the VHF marine band lie between 156 and 158 MHz with some shore stations available between 161 and 163 MHz. The marine VHF band provides communications over distances that are essentially “line of sight” (VHF signals do not travel well through objects such as buildings, hills or trees). Actual transmission range depends much more on antenna type, gain and height than on the power output of the transmitter. On a fixed mount 25W radio transmission expected distances can be greater than 15 miles, for a portable 5W radio transmission the expected distance can be greater than 5 miles in “line of sight”.

5.3 SELECTING AN ANTENNA

Marine antennas are made to radiate signals equally in all horizontal directions, but not straight up. The objective of a marine antenna is to enhance the signal toward the horizon. The degree to which this is accomplished is called the antenna’s gain. It is measured in decibels (dB) and is one of the major factors in choosing an antenna. In terms of effective radiated power (ERP), antennas are rated on the basis of how much gain they have over a theoretical antenna with zero gain. A 3 foot, 3dB gain antenna represents twice as much gain over the imaginary antenna.

Typically a 3 foot 3dB gain stainless steel whip is used on a sailboat mast. The longer 8 foot 6dB fiberglass whip is primarily used on power boats that require the additional gain.

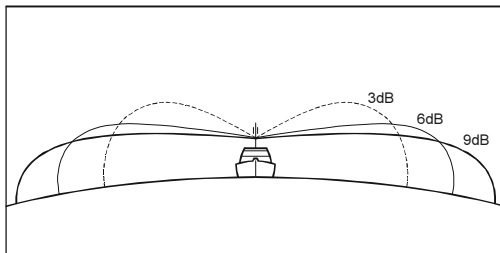

5.4 COAXIAL CABLE

VHF antennas are connected to the transceiver by means of a coaxial cable – a shielded transmission line. Coaxial cable is specified by its diameter and construction.

For runs less than 20 feet, RG-58/U, about 1/4 inch in diameter is a good choice. For runs over 20 feet but less than 50 feet, the larger RG-8X or RG-213/U should be used for cable runs over 50 feet RG-8X should be used. For installation of the connector onto the coaxial cable refer to the figure below.

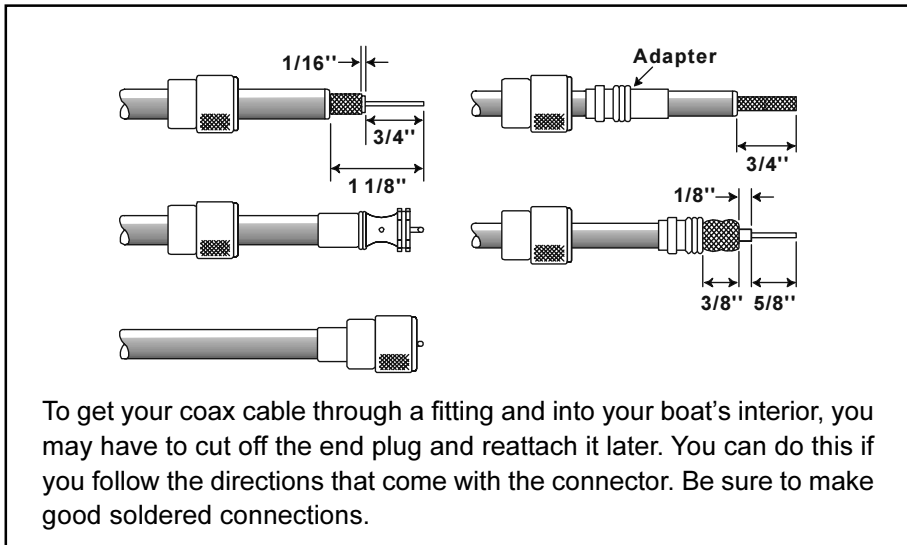

5.5 DISTRESS AND HAILING (CHANNEL 16)

Channel 16 is known as the Hail and Distress Channel. An emergency may be defined as a threat to life or property. In such instances, be sure the transceiver is on and set to CHANNEL 16. Then use the following procedure:

1. Press the microphone push-to-talk switch and say "**Mayday, Mayday, Mayday**. This is _____, _____, _____" (your vessel's name).
2. Then repeat once: "**Mayday**, _____" (your vessel's name).
3. Now report your position in latitude/longitude, or by giving a true or magnetic bearing (state which) to a well-known landmark such as a navigation aid or geographic feature such as an island or harbor entry.
4. Explain the nature of your distress (sinking, collision, aground, fire, heart attack, life-threatening injury, etc.).
5. State the kind of assistance your desire (pumps, medical aid, etc.).
6. Report the number of persons aboard and condition of any injured.

7. Estimate the present seaworthiness and condition of your vessel.
8. Give your vessel's description: length, design (power or sail), color and other distinguishing marks. The total transmission should not exceed 1 minute.
9. End the message by saying "**OVER**". Release the microphone button and listen.
10. If there is no answer, repeat the above procedure. If there is still no response, try another channel.

NOTE

The **GX2000** and **GX2150** have DSC Distress calling, that can transmit a distress call digitally to all ships with compatible DSC radios. Refer to section "**9 DIGITAL SELECTIVE CALLING**".

5.6 CALLING ANOTHER VESSEL (CHANNEL 16 OR 9)

Channel 16 may be used for initial contact (hailing) with another vessel. However, its most important use is for emergency messages. This channel must be monitored at all times except when actually using another channel. It is monitored by the U.S. and Canadian Coast Guards and by other vessels. **Use of channel 16 for hailing must be limited to initial contact only.** Calling should not exceed 30 seconds, but may be repeated 3 times at 2-minute intervals. In areas of heavy radio traffic, congestion on channel 16 resulting from its use as a hailing channel can be reduced significantly in U.S. waters by using **channel 9** as the initial contact (hailing) channel for non-emergency communications. Here, also, calling time should not exceed 30 seconds but may be repeated 3 times at 2-minute intervals.

Prior to making contact with another vessel, refer to the channel charts in this manual, and select an appropriate channel for communications after initial contact. For example, Channels 68 and 69 of the U.S. VHF Charts are some of the channels available to non-commercial (recreational) boaters. Monitor your desired channel in advance to make sure you will not be interrupting other traffic, and then go back to either channel 16 or 9 for your initial contact.

When the hailing channel (16 or 9) is clear, press the **PTT** button on the mic and state the name of the other vessel you wish to call and then "**this is**" followed by the name of your vessel and your Station License (Call Sign) then release the **PTT** button on the mic. When the other vessel returns your call, immediately request another channel by pressing the **PTT** button on the mic and saying "**go to**," the number of the other channel, say "over" and release the **PTT** button on the mic. Then switch to the new channel. When the new channel is not busy, call the other vessel.

After a transmission, say “**over**,” and release the microphone’s push-to-talk (PTT) switch. When all communication with the other vessel is completed, end the last transmission by stating your Call Sign and the word “**out**.” Note that it is not necessary to state your Call Sign with each transmission, only at the beginning and end of the contact.

Remember to return to Channel 16 when not using another channel. Some radios automatically monitor Channel 16 even when set to other channels or when scanning.

5.7 MAKING TELEPHONE CALLS

To make a radiotelephone call, use a channel designated for this purpose, The fastest way to learn which channels are used for radiotelephone traffic is to ask at a local marina. Channels available for such traffic are designated **Public Correspondence** channels on the channel charts in this manual. Some examples for USA use are Channels 24, 25, 26, 27, 28, 84, 85, 86, and 87. Call the marine operator and identify yourself by your vessel’s name, The marine operator will then ask you how you will pay for the call (telephone credit card, collect, etc.) and then link your radio transmission to the telephone lines.

The marine telephone company managing the VHF channel you are using may charge a link-up fee in addition to the cost of the call.

5.8 BRIDGE CHANNELS 13 AND 67

Channel 13 is used at docks and bridges and by vessels maneuvering in port. Messages on this channel must concern navigation only, such as meeting and passing in restricted waters.

Channel 67 is used for navigational traffic between vessels.

By regulation, power is normally limited to 1 Watt on these channels. Your radio is programmed to automatically reduce power to this limit on these channels. However, in certain situations it may be necessary to temporarily use a higher power. See page 25 ( key) for means to temporarily override the low-power limit on these two channels.

5.9 AUTOMATED RADIO CHECK SERVICE

In areas across the country, Sea Tow offers boaters a way to conduct radio checks. To use Sea Tow’s free Automated Radio Check service, simply tune your VHF radio to the appropriate channel for your location and conduct a radio check as you typically would. Upon releasing your radio’s microphone, the system will play an automated message and relay your transmission back to you, thereby letting you know how your signal will sound to other boaters.

The Automated Radio Check Service is currently available in the areas listed below.

West Coast	Sea Tow Newport/LA - Ch. 27 Sea Tow San Diego - Ch. 27
Northeast	Sea Tow Portland-Midcoast (Maine) - Ch. 27 Sea Tow Boston - Ch. 27 Sea Tow South Shore (Mass.) - Ch. 28 Sea Tow Rhode Island - Ch. 24 Sea Tow Eastern Long Island - Ch. 27 Sea Tow Huntington (N.Y.) - Ch. 27 Sea Tow Manasquan (N.J.) - Ch. 28
Mid-Atlantic	Sea Tow Northern Chesapeake (Md.) - Ch. 28 Sea Tow Central Chesapeake (Md.) - Ch. 27 Sea Tow Hampton Roads (Va.) - Ch. 28
North Carolina	Sea Tow Wrightsville Beach - Ch. 28 Sea Tow Ocean Isle Beach - Ch. 28
Florida	Sea Tow Sebastian - Ch. 28 Sea Tow Fort Lauderdale - Ch. 27 Sea Tow Charlotte Harbor - Ch. 24 Sea Tow Tampa Bay - Ch. 27 Sea Tow Horseshoe Beach - Ch. 27 Sea Tow Carrabelle/St. Marks - Ch. 27 Sea Tow Pensacola/Orange Beach (Ala.) - Ch. 27

5.10 WHAT IS THE RANGE FOR AIS RECEIVERS?

Since AIS uses similar frequencies as a marine VHF radio, it has similar radio reception capabilities - which are basically line of sight. This means that the higher the VHF antenna is mounted, the greater the reception area will be. Reception from Class A vessels that are 20 or even 30 miles away on open water is not uncommon as their antennas are mounted high off the water. Class B transponders use lower power for transmissions; therefore you can expect Class B vessels to be acquired when they are 5 to 10 miles away.

NOTE

The MATRIX AIS **GX2150** does not require a special marine VHF antenna to receive AIS transmissions. The MATRIX AIS does not transmit AIS signals, it is NOT recommended to use an antenna dedicated for AIS operation.

For additional information on AIS visit the USCG web site: <<http://www.navcen.uscg.gov/marcomms/ais.htm>>

6 INSTALLATION

6.1 SAFETY / WARNING INFORMATION

This radio is restricted to occupational use, work related operations only where the radio operator must have the knowledge to control the exposure conditions of its passengers and bystanders by maintaining the minimum separation distance of 0.89 m (2.92 feet). Failure to observe these restrictions will result in exceeding the FCC RF exposure limits.

Antenna Installation:

The antenna must be located at least 0.89 m (2.92 feet) away from passengers in order to comply with the FCC RF exposure requirements.

6.2 LOCATION

The radio can be mounted at any angle. Choose a mounting location that:

- is far enough from any compass to avoid any deviation in compass reading due to the speaker magnet
- provides accessibility to the front panel controls
- allows connection to a power source and an antenna
- has nearby space for installation of a microphone hanger
- choose a mounting location that is at least 3 feet (1 m) away from the radio's antenna.

Note: To insure the radio does not affect the compass or radios performance is not affected by the antenna location, temporarily connect the radio in the desired location and:

- a. Examine the compass to see if the radio causes any deviation
- b. Connect the antenna and key the radio. Check to ensure the radio is operating correctly by requesting a radio check.

6.3 MOUNTING THE RADIO

6.3.1 Supplied Mounting Bracket

The supplied mounting bracket allows overhead or desktop mounting.

Use a 13/64" (5.2-mm) bit to drill the holes to a surface which is more 0.4 inch (10 mm) thick and can support more than 3.3 lbs (1.5 kg) and secure the bracket with the supplied screws, spring washers, flat washers, and nuts.

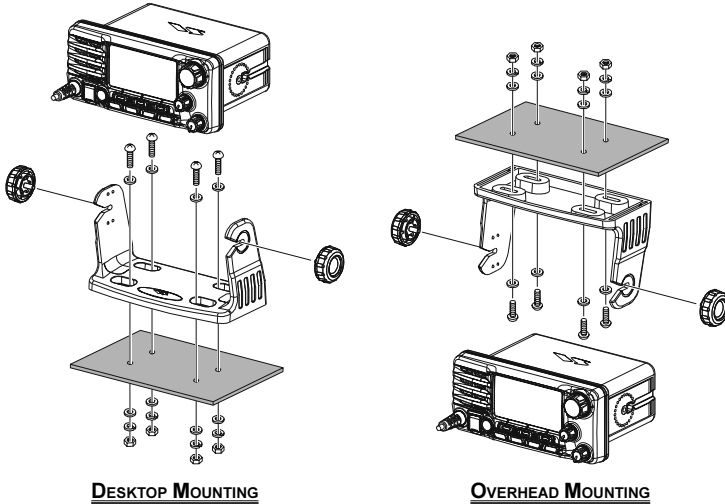

6.3.2 Optional MMB-84 Flush Mount Bracket

1. Use the supplied template to mark the location where the rectangular hole is to be cut. Confirm the space behind the dash or panel is deep enough to accommodate the transceiver (at least 6.7 inches (17 cm) deep). There should be at least 1/2 inch (1.3 cm) between the transceiver's heatsink and any wiring, cables or structures.
2. Cut out the rectangular hole and insert the transceiver.
3. Fasten the brackets to the sides of the transceiver with the lock washer screw combination; so that the mounting screw base faces the mounting surface.
4. Turn the adjusting screw to adjust the tension so that the transceiver is tight against the mounting surface.

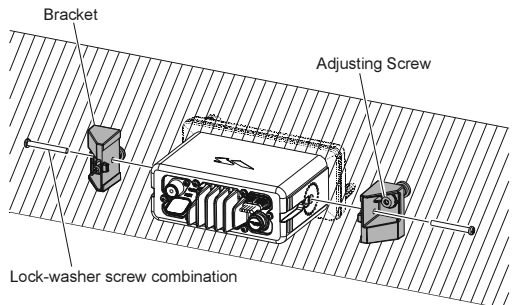

6.4 ELECTRICAL CONNECTIONS

CAUTION

Reverse polarity battery connections will damage the radio!

Connect the power cord and antenna to the radio. Antenna and Power Supply connections are as follows:

1. Mount the antenna at least 3 feet (1 m) away from the radio. At the rear of the radio, connect the antenna cable. The antenna cable must have a PL259 connector attached. RG-8/U coaxial cable must be used if the antenna is 25 feet (7.6 m) or more from the radio. RG58 cable can be used for distances less than 25 feet (7.6 m).
2. Connect the red power wire to a 13.8 VDC $\pm 20\%$ power source. Connect the black power wire to a negative ground.
3. If an optional remote extension speaker is to be used, refer to section 8.4 for connections.
4. It is advisable to have a Certified Marine Technician check the power output and the standing wave ratio of the antenna after installation.

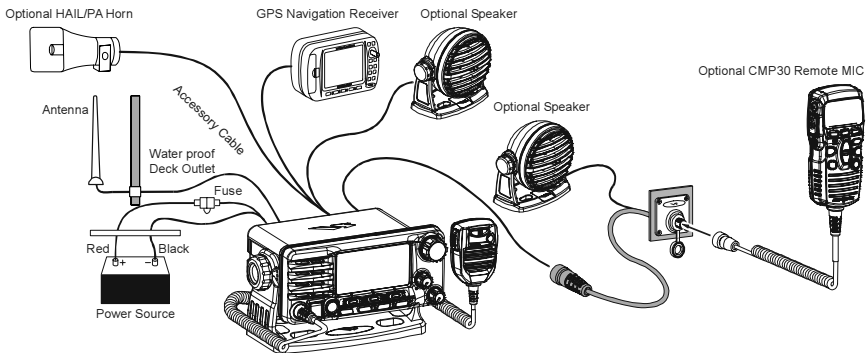

Fuse Replacement

To take out the Fuse from the Fuse Holder, hold both ends of the Fuse Holder and pull the Fuse Holder apart without bending the fuse Holder. When you replace the Fuse, please confirm that the Fuse is tightly fixed on the metal contact located inside the Fuse Holder. If the metal contact holding the fuse is loose, the Fuse holder may heat up.

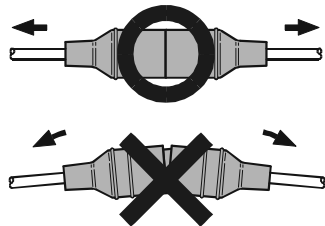

6.5 ACCESSORY CABLES

6.5.1 MATRIX GX2000 Connection

The image and table below show the wires of the MATRIX (GX2000) and the connections to optional devices such as a PA Speaker (Horn), External Speaker, GPS Chart plotter and a AIS receiver or Transponder.

The MATRIX uses NMEA 0183 protocol to communicate to a GPS chart plotter and a AIS device. GPS Chart Plotter connections are at 4800 baud and AIS device signalling is at 38400 baud sometimes called High Speed (HS).

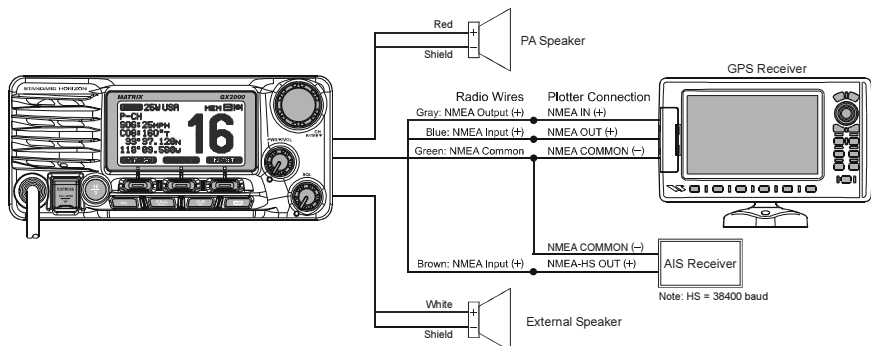

Wire Color/Description	Connection Examples
WHITE - External Speaker (+)	Positive wire of an 4 Ohm external speaker
SHIELD - External Speaker (-)	Negative wire of an 4 Ohm external speaker
RED - PA Speaker (+)	Positive wire of an 4 Ohm PA speaker (horn)
SHIELD - PA Speaker (-)	Negative wire of an 4 Ohm PA speaker (horn)
GREEN - NMEA Ground	GPS Chart Plotter NMEA 0183 common
BLUE - NMEA GPS Input (+)	GPS Chart Plotter NMEA 0183 output positive wire ^{※1}
GRAY - NMEA DSC Output (+)	GPS Chart Plotter NMEA 0183 input positive wire ^{※1}
BROWN - AIS DATA Input (+)	AIS Receiver or Transponder NMEA 0183 output positive ^{※2}

※1: 4800 baud

※2: 38400 baud

6.6 MATRIX AIS+ CONNECTIONS

The image and table below show the wires of the MATRIX AIS+ (**GX2150**) and the connections to optional devices such as a PA Speaker (Horn), External Speaker and a GPS Chart plotter.

The **GX2150** uses NMEA 0183 protocol to share coordinates, DSC and AIS information to and from a GPS chart plotter. The **GX2150** transfers targets to a GPS Chart plotter or PC at 38400 baud (sometimes called High Speed HS). GPS and DSC information is transferred to a GPS Chart Plotter with multiple ports (minimum 2) at 4800 baud (default setting).

To connect to a GPS Chart Plotter which has one NMEA port, the **GX2150** may be setup to receive GPS coordinates, send DSC and AIS signals at 38400. Refer to section “**10.10 NMEA DATA IN/OUT**” for details.

6.6.1 MATRIX AIS+ 4800 Baud Connections

Use the image and table below when connecting to a GPS Chart plotter which has two or more NMEA 0813 ComPorts.

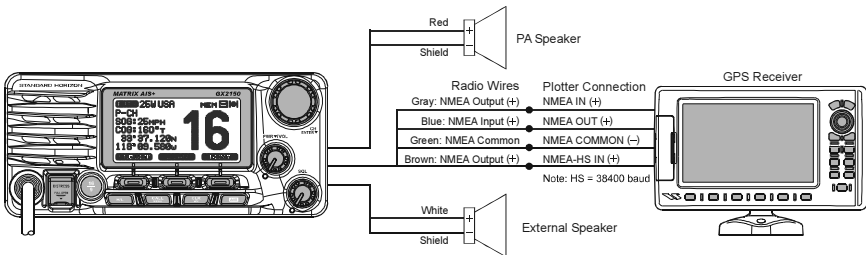

Wire Color/Description	Connection Examples
WHITE - External Speaker (+)	Positive wire of an 4 Ohm external speaker
SHIELD - External Speaker (-)	Negative wire of an 4 Ohm external speaker
RED - PA Speaker (+)	Positive wire of an 4 Ohm PA speaker (horn)
SHIELD - PA Speaker (-)	Negative wire of an 4 Ohm PA speaker (horn)
GREEN - NMEA Ground	GPS Chart Plotter NMEA 0183 common
BLUE - NMEA GPS Input (+)	GPS Chart Plotter NMEA 0183 output positive wire ^{※1}
GRAY - NMEA DSC Output (+)	GPS Chart Plotter NMEA 0183 input positive wire ^{※1}
BROWN - AIS DATA Output (+)	GPS Chart Plotter NMEA input positive wire ^{※2}

※1: 4800 baud

※2: 38400 baud

6.6.2 MATRIX AIS+ 38400 Baud Connections

Use the image and table below when connecting to a GPS Chart plotter which has one NMEA 0813 ComPort.

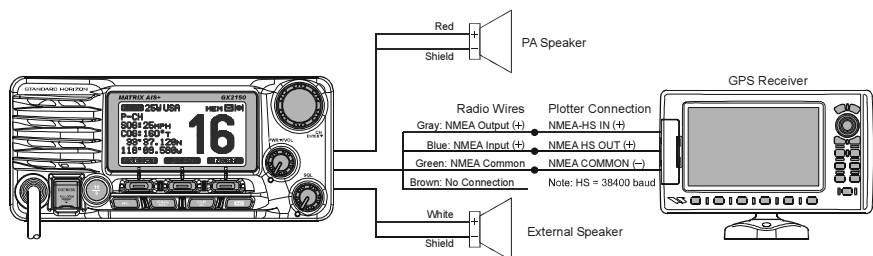

Wire Color/Description	Connection Examples
WHITE - External Speaker (+)	Positive wire of an 4 Ohm external speaker
SHIELD - External Speaker (-)	Negative wire of an 4 Ohm external speaker
RED - PA Speaker (+)	Positive wire of an 4 Ohm PA speaker (horn)
SHIELD - PA Speaker (-)	Negative wire of an 4 Ohm PA speaker (horn)
GREEN - NMEA Ground	GPS Chart Plotter NMEA 0183 common
BLUE - NMEA GPS Input (+)	GPS Chart Plotter NMEA 0183 output positive wire ^{※1}
GRAY - NMEA DSC Output (+)	GPS Chart Plotter NMEA 0183 input positive (A) wire ^{※1}
BROWN - AIS DATA Output (+)	No Connection ^{※2}

※1: The GPS Chart plotter ComPort must be setup to 38400 baud (HS) to send GPS coordinates to the GX2150 (Blue wire) and to receive DSC and AIS sentences from the **GX2150** (Gray wire).

※2 The MATRIX AIS+ always outputs NMEA 0183 VDM sentence at 38400. This wire could be connected to another GPS Chart Plotter or to a PC.

When connecting the external speaker or GPS navigation receiver, strip off about 1 inch (2.5 cm) of the specified wire's insulation, then splice the ends together.

Note: In some areas powerful AM broadcast stations may be heard when in listen-back mode. In this case change the speaker wire to 2-conductor shielded audio cable. See the illustration below for connections.

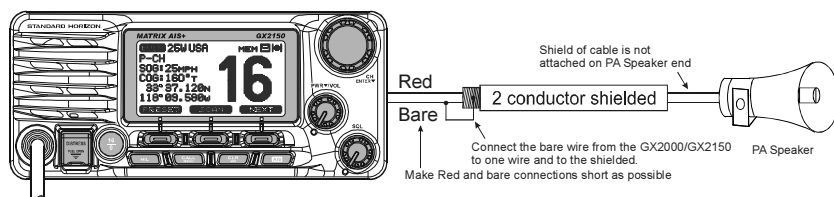

GPS Connections (GX2000: 4800 baud)

NMEA INPUT (GPS Information)

- The GPS must have the NMEA Output turned on and set to 4800 Baud in the setup menu. If there is a selection for parity select none.
- For further information on interfacing /setting up your GPS. Please contact the manufacturer of the GPS receiver.
- **GX2000** can read NMEA-0183 version 2.0 or higher.
- The NMEA 0183 input sentences are GLL, GGA, RMC, and GNS (RMC sentence is recommended).

NMEA Output (DSC)

The NMEA 0183 output sentences are DSC and DSE.

GPS Connections (GX2150: 4800 baud or 38400 baud)

NMEA INPUT (GPS Information)

- The **GX2150** can select the NMEA baud rate between “4800 bps” and “38400 bps”. Refer to section “**10.10 NMEA DATA IN/OUT**” for selection.
- For further information on interfacing /setting up your GPS, please contact the manufacturer of the GPS receiver.
- **GX2150** can read NMEA-0183 version 2.0 or higher.
- The NMEA 0183 input sentences are GLL, GGA, RMC, GNS, GSA, and GSV (RMC sentence is recommended).

NMEA Output (DSC)

The NMEA 0183 output sentences are DSC and DSE.

If 4800 baud (default) is selected:

- a. The Gray wire of the **GX2150** outputs DSC and DSE sentences
- b. The Brown wire outputs AIS VDM sentence at 38400.

If 38400 baud is selected:

- a. The Blue wire of the **GX2150** input is at 38400 baud
- b. The Gray wire of the **GX2150** output is at 38400 baud and includes both DSC (DSC, DSE) and AIS (VDM) sentences.
- c. The brown wire does not change, it always outputs AIS sentences at 38400 baud.

NOTE

The **GX2150** has a GPS status page which shows the signal strength and locations of satellites. For the **GX2150** to show the display correctly a GPS must be connected and configured to output GSA and GSV NMEA 0183 sentences.

If you have further inquires, please feel free to contact Product Support at:

Phone: (800) 767-2450

Email: marinetech@vxstdusa.com

6.7 CHECKING GPS CONNECTIONS

After connections have been made between the **GX2000/GX2150** and the GPS, a small satellite icon will appear on the top right corner of the display and your current location (Latitude/Longitude) will be shown on the display.

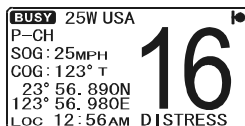

NOTE

If there is a problem with the NMEA connection between the radio and the GPS, the GPS icon will blink continuously until the connection is corrected.

6.8 CHANGING THE GPS TIME

From the Factory the **GX2000/GX2150** shows GPS satellite time or UTC time when an optional GPS is connected. A time offset is needed to show the local time in your area. The Time Offset must be changed in order for the radio to display the current time in your area. Please see the Offset Time Table at the bottom of this page.

1. Press and hold down the  key until "Setup Menu" appears, then select "GENERAL SETUP" with the **CHANNEL** knob.
2. Press the **SELECT** soft key, then select "TIME OFFSET" with the **CHANNEL** knob.
3. Press the **SELECT** soft key, then rotate the **CHANNEL** knob to select time offset of your location. See illustration below to find your offset time. If "00:00" is assigned, the time is the same as UTC (Universal Time Coordinated or GPS Satellite Time).
4. Press the **ENT** soft key to store the time offset.
5. Press the **QUIT** soft key several times to return to radio operation.

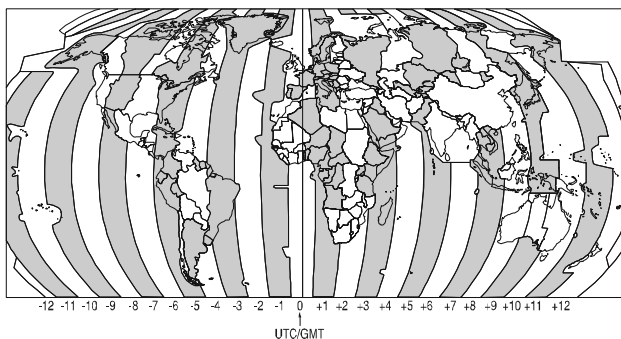
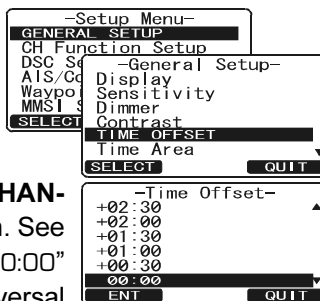

OFFSET TIME TABLE

6.9 CHANGING THE TIME AREA

This menu selection allows the radio to show UTC time or your local time with the offset which is enabled in section “6.8 CHANGING THE GPS TIME”.

1. Press and hold down the  key until “Setup Menu” appears, then select “GENERAL SETUP” with the **CHANNEL** knob.
2. Press the **SELECT** soft key, then rotate the **CHANNEL** knob to “TIME AREA”.
3. Press the **SELECT** soft key.
4. Rotate the **CHANNEL** knob to select “UTC” or “LOCAL”.
5. Press the **ENT** soft key to store the selected setting.
6. Press the **QUIT** soft key several times to return to radio operation.

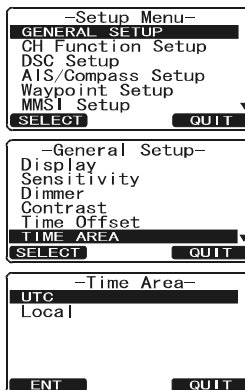

6.10 CHANGING THE TIME DISPLAY

This menu selection allows the radio to setup to show time in 12-hour or 24-hour format.

1. Press and hold down the  key until “Setup Menu” appears, then select “GENERAL SETUP” with the **CHANNEL** knob.
2. Press the **SELECT** soft key, then rotate the **CHANNEL** knob to select “TIME DISPLAY”.
3. Press the **SELECT** soft key.
4. Rotate the **CHANNEL** knob to select “12 HOUR” or “24 HOUR”.
5. Press the **ENT** soft key to store the selected setting.
6. Press the **QUIT** soft key several times to return to radio operation.

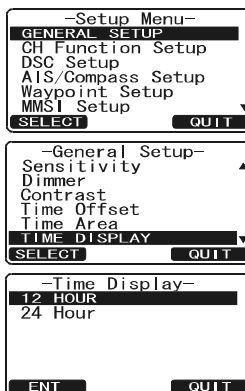

6.11 CHANGING COG TO TRUE OR MAGNETIC

Allows the GPS COG (Course Over Ground) and the BRG from a AIS target to be selected to show in True or Magnetic. Factory default is True however by following the steps below the COG can be changed to Magnetic.

1. Press and hold down the  key until "Setup Menu" appears, then select "GENERAL SETUP" with the **CHANNEL** knob.
2. Press the **SELECT** soft key, then rotate the **CHANNEL** knob to select "MAGNETIC".
3. Press the **SELECT** soft key.
4. Rotate the **CHANNEL** knob to select "MAGNETIC" or "TRUE".
5. Press the **ENT** soft key to store the selected setting.
6. Press the **QUIT** soft key several times to return to radio operation.

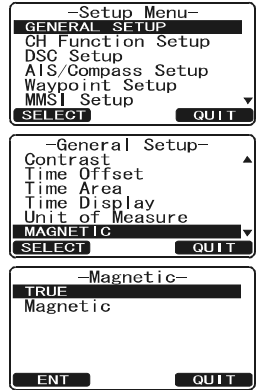

6.12 OPTIONAL RAM3 (CMP30) INSTALLATION

The **GX2000/GX2150** is capable of using a **RAM3 (CMP30)** Remote Station Microphone to remotely control the Radio, AIS, DSC and PA/Fog functions. In addition the **GX2000/GX2150** can operate as a full function intercom system between the **RAM3 (CMP30)** and the **GX2000/GX2150**.

1. Connect the Extension Cable to the Remote Mic eight pin connector on the rear panel, then tighten the Cable Nut (see illustration at the right).
2. Install the ferrite core (supplied with the **RAM3 (CMP30)** Remote Station Microphone) to the Extension Cable, then snap its two halves together, per the illustration below.
3. Attach the ferrite core as close as possible to the MIC plug, as shown.
4. Finally, wind some plastic tape around each ferrite core, to prevent vibration from causing the two halves to split apart.

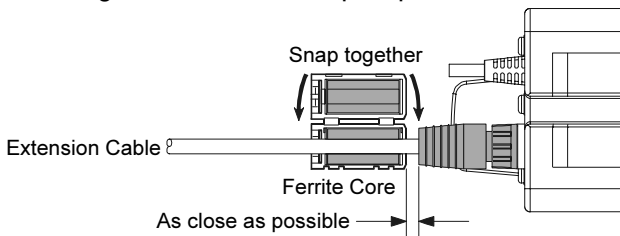
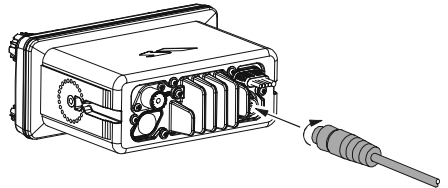

- Referring to illustration below, make a 1.2" (30 mm) hole in the wall, then insert the Extension Cable into this hole. Connect the Gasket and Mount Base to the Extension Cable Connector using the Nut.
- Drill the four Screw holes (approx. 2 mm) on the wall, then install the Mounting Base to the wall using four screws.
- Put the Rubber Cap on to the Nut. The installation is now complete.

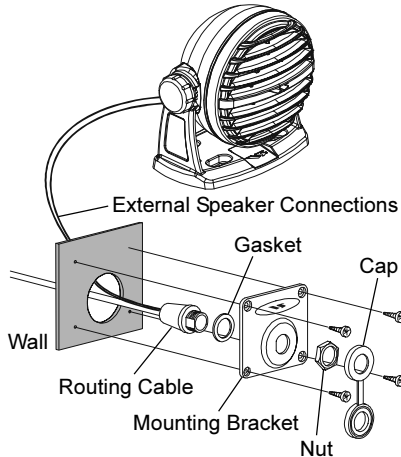

NOTE











The routing cable can be cut and spliced, however care needs to be taken when reconnecting the wires to ensure water integrity. Before cutting the cable make sure it is not plugged into the radio. After cutting you will notice there are the following wires:
Yellow, Green, Brown, Purple, Blue, Green, Red*, Shield*
* The red and shield wires are wrapped in foil. Remove the foil, and separate the Red and shield wires.

WARNING

It is not recommended to plug or unplug the **RAM3 (CMP30)** Remote Station Microphone into the routing cable while the radio is on.

6.12.1 Connecting an External Speaker to the RAM3 Mic Cable





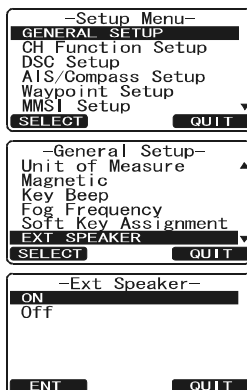





In noisy locations and optional external speaker may be connected to the white speaker wires on the **RAM3 (CMP30)** routing cable. The **RAM3 (CMP30)** can drive the internal speaker or the external speaker one at a time. When connecting an external speaker, follow the procedure below to turn off the **RAM3 (CMP30)** audio and enable the external speaker wires on the **RAM3 (CMP30)** routing cable.

1. On the RAM3 mic, press and hold the  key until "Setup Menu" appears, then select "GENERAL SETUP" with the  /  key.
2. Press the  soft key.
3. Press the  key to until "EXT SPEAKER" is shown and press the  soft key.
4. Press the  or  key to select "OFF" (External speaker off) or "ON" (External speaker on).
5. Press the  soft key to save the selection.
6. Press the  key to exit this mode.



6.12.2 External Speaker AF Selection

The "AF Select" menu allows you to set the audio output level of the **RAM3 (CMP30)** external speaker wires (on routing cable) to a fixed level regardless of the volume level setting of the **RAM3 (CMP30)** which is useful when using the optional **MLS-310** amplified speaker with on/off volume control.

1. On the RAM3 mic, press and hold the  key until "Setup Menu" appears, then select "GENERAL SETUP" with the  /  key.
2. Press the  soft key.
3. Press the  key to until "AF SELECT" is shown and press the  soft key.
4. Press the  or  key to select "PR" (External Speaker Level is "Fixed") or "PO" (External Speaker Level is "Adjustable").
"Fixed" use when **MLS-310** is connected.
"Adjustable" use when **MLS-300** or other speaker without volume control is connected.
5. Press the  soft key to save the selection.
6. Press the  key to exit this mode.

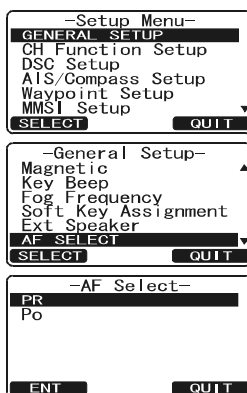

7 CONTROLS AND INDICATORS

NOTE

This section defines each control of the transceiver. See illustration at the next page for location of controls. For detailed operating instructions refer to chapter 8 of this manual.

7.1 FRONT PANEL

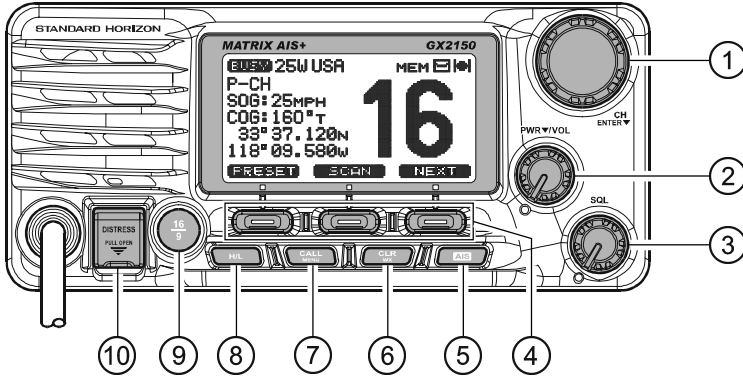

① CHANNEL Knob

Rotary knob is used to select channels and to choose menu items (such as the DSC menu, Radio Setup and DSC Setup menu). The / keys on the microphone can also be used to select channels and menu items.

SECONDARY USE

- Press this knob to enter a selection in the “SETUP MENU” or “DSC MENU”.
- While holding down the **SCAN** soft key and turning this knob, you can confirm memory channels that have been programmed for scanning.
- When in the PA or Fog mode, turning this knob changes the output volume of the connected horn speaker.

② PWR/VOL Knob (Power Switch / Volume Control)

Turns the transceiver on and off as well as adjusts the speaker volume. To turn the transceiver on, press and hold this knob until the radio turns on. When the power is turned on, the transceiver is set to the last selected channel. Clockwise rotation of this knob increases the internal and speaker microphone volume.

To turn the transceiver off, press and hold this knob until the radio turns off.

SECONDARY USE

When in PA or Fog mode, controls the listen back volume (**GX2150** only).

③ **SQL Knob (Squelch Control)**

Adjusting this control clockwise, sets the point at which random noise on the channel does not activate the audio circuits but a received signal does. This point is called the squelch threshold. Further adjustment of the squelch control will degrade reception of wanted transmissions.

④ **Soft Keys**

The 3 soft keys functions can be customized by the Setup Menu mode section “**10.14 SOFT KEYS**”. When one of the soft keys is pressed briefly, the functions will appear above each key on the display.

The factory defaults are Key 1: **PRESET**, Key 2: **SCAN**, Key 3: **DW**, and Key 4: **PA/FOG**.

⑤ **AIS** Key

Press the **AIS** key to display the AIS (Automatic Identification System) targets information on the display. Refer to section “**13.7 AIS OPERATION**” for details.

Note: For this key to operate on the **GX2000** an optional AIS receiver or transponder and a GPS with NMEA 0183 output must be connected to show AIS targets on the radios display. On the **GX2150** a GPS must be connected to the radio to show AIS targets on the radios display.

⑥ **CLR WX** Key

Press the **CLR WX** key briefly to cancel a selection the “Setup Menu” and “DSC Menu”.

Press and hold the **CLR WX** key to recall the previously selected NOAA weather channel from any channel. Press and hold the **CLR WX** key again reverts to the previous selected working channel.

⑦ **CALL MENU** Key

Press the **CALL MENU** key to access the “DSC MENU”.

SECONDARY USE

Press and hold the **CALL MENU** key to access the “SETUP MENU”.



⑧ **H/L** Key

Press the **H/L** key to toggle between 25 W (High) and 1 W (Low) power. When the TX output power is set to “Low” while the transceiver is on channel 13 or 67, the output power will temporarily switch from “Low” to “High” power until the **PTT** is released. The **H/L** key does not function on transmit inhibited and low power only channels.

SECONDARY USE

When the Normal (Radio display) is selected, push and hold this key to show or hide SOG and COG on the display.

9  Key

Press the  key briefly to recall channel 16 from any channel location. Press and hold the  key to recall channel 9. Pressing the [16/9] key again reverts to the previous selected working channel.

10 [DISTRESS] Key

Used to send a DSC Distress Call. To send the distress call refer to section “9.3.1 Transmitting a DSC Distress Alert”.

7.2 REAR PANEL

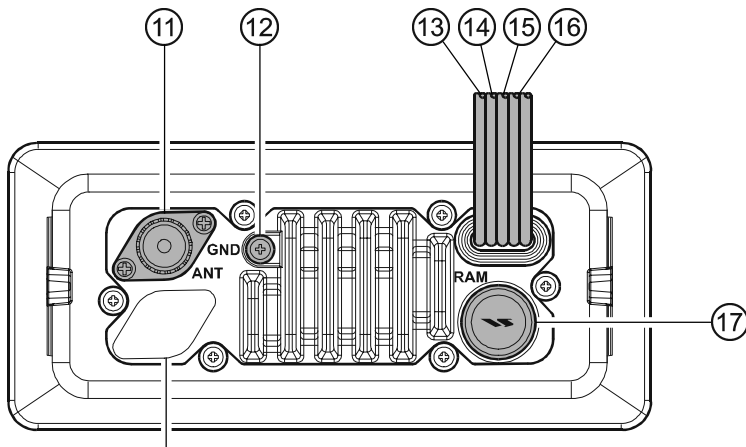

Never remove this rubber cap. When this rubber cap is removed, the water resistance performance is lost.

11 **ANT** Jack (Antenna Jack)

Connects an antenna to the transceiver. Use a marine VHF antenna with an impedance of 50 ohms.

Note: On the **GX2150** the antenna connection is used to receive marine and AIS transmissions.

12 **GND** Terminal (Ground Terminal)

Connects the **GX2000/GX2150** to a good ground, for safe and optimum performance.

Use the screw supplied with the **GX2150** and **GX2000** only.

13 Accessory Connection Cable (Green, Blue, Gray, & Brown)

Connects the **GX2000/GX2150** to a GPS receiver and AIS receiver (**GX2000**). Refer to section “6.5 ACCESSORY CABLE”.

- ⑭ PA Speaker Connection Cable (Red & Shield)
Connects the **GX2000/GX2150** to a optional PA speaker. Refer to section “**3 OPTIONS**” for a list of optional STANDARD HORIZON Speakers.
- ⑮ External Speaker Connection Cable (White & Shield)
an external speaker. See section “**3 OPTIONS**” for a list of optional STANDARD HORIZON Speakers.
- ⑯ DC Input Cable
Connects the radio to a DC power supply capable of delivering 11 to 16V DC.
- ⑰ **RAM3** Connector (Remote Station Microphone Connector)
Connects the **GX2000/GX2150** to the **RAM3 (CMP30)** Remote Station Microphone. Refer to section “**15 RAM3 (CMP30) REMOTE MIC OPERATION**” for details

7.3 MICROPHONE

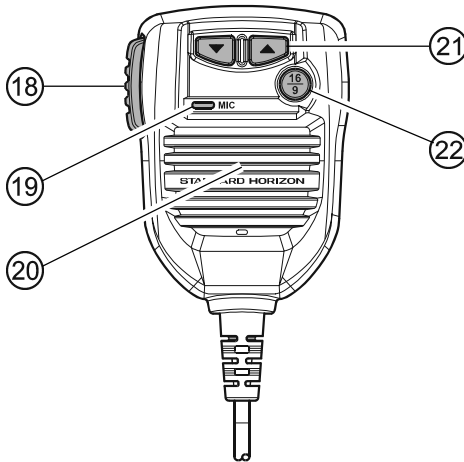

⑱ PTT Switch (Push-To-Talk Switch)

1. When in radio mode and the **PTT** button pressed, the transmitter is enabled for voice communications to another vessel.
2. When PA mode is selected, pressing the **PTT** button allows your voice to be amplified and supplied to a connected PA horn.
3. When an optional **RAM3 (CMP30)** Remote Station Microphone is connected and intercom mode is selected, pressing the **PTT** button enables voice communications from the **GX2000/GX2150** to the **RAM3 (CMP30)** Remote Station Microphone.

⑲ Microphone

The microphone has ClearVoice Noise Reduction Technology which reduces the amount of background (wind, engine) noise transmitted.

Note: Position your mouth about 1/2" away from the microphone hole and speak in a normal voice.

⑳ Microphone Speaker

Audio heard through internal radio speaker is heard through speaker inside the microphone.

㉑ ▼ / ▲ Keys

The ▼ and ▲ on the microphone function the same as the **CHANNEL** knob on the front panel of the transceiver.

㉒ $\frac{16}{9}$ Key

Pressing the $\frac{16}{9}$ key immediately recalls channel 16 from any location. Press and hold the $\frac{16}{9}$ key to recall channel 9. Pressing the $\frac{16}{9}$ key again will revert the radio to the previous selected channel.

8 BASIC OPERATION

8.1 RECEPTION

1. After the transceiver has been installed, ensure that the power supply and antenna are properly connected.
2. Press and hold the **PWR▼/VOL** knob until the radio turns on.
3. Rotate the **SQL** knob fully counterclockwise. This state is known as “squelch off”.
4. Turn up the **PWR▼/VOL** knob until noise or audio from the speaker is at a comfortable level.
5. Rotate the **SQL** knob clockwise until the random noise disappears. This state is known as the “squelch threshold.”
6. Rotate the **CHANNEL** knob to select the desired channel. Refer to the channel chart on page 117 for available channels.
7. When a message is received, adjust the volume to the desired listening level. The “**BUSY**” indicator on the display indicates communications is being received.

8.2 TRANSMISSION

1. Perform steps 1 through 6 of RECEPTION.
2. Before transmitting, monitor the channel to ensure it is clear.
THIS IS AN FCC REQUIREMENT!
3. Press the **PTT** (push-to-talk) switch. The “**TX**” indicator on the LCD is displayed.
4. Speak slowly and clearly into the microphone.
5. When the transmission is finished, release the **PTT** switch.

NOTE

This is a noise-canceling microphone. Position the Oval Slot label “**MIC**” within 1/2 inch (1.3 cm) from the mouth for optimum performance.

8.3 TRANSMIT TIME - OUT TIMER (TOT)

When the **PTT** switch on the microphone is held down, transmit time is limited to 5 minutes. This limits unintentional transmissions due to a stuck microphone. About 10 seconds before automatic transmitter shutdown, a warning beep will be heard from the speaker(s). The transceiver will automatically go to receive mode, even if the **PTT** switch is continually held down. Before transmitting again, the **PTT** switch must first be released and then pressed again.

8.4 SIMPLEX/DUPLEX CHANNEL USE

Refer to the VHF MARINE CHANNEL CHART (page 117) for instructions on use of simplex and duplex channels.

NOTE

All channels are factory-programmed in accordance with FCC (USA), Industry Canada (Canada), and International regulations. Mode of operation cannot be altered from simplex to duplex or vice-versa.

8.5 DISPLAY TYPE

The **GX2000/GX2150** display can be setup to show displays other than the default “NORMAL” VHF display by using the procedure below:

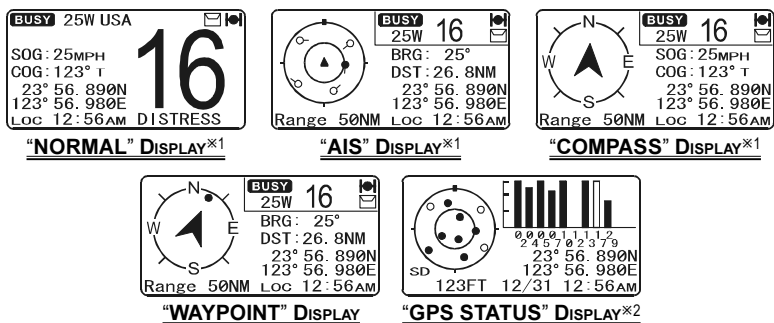

NOTE

1. By default the COG in “NORMAL” and “COMPASS” displays and BRG in “AIS”, “COMPASS”, and “WAYPOINT” displays are set to “True”, however this may be change to magnetic by following the steps in section “10.9 MAGNETIC”.
2. The “GPS STATUS” display is only available on the **GX2150**. For this display to operate correctly, the **GX2150** must be connected to a GPS Chart plotter which outputs NMEA 0183 GSA and GSV sentences.

1. Press and hold down the **CALL MENU** key until “Setup Menu” appears, then select “GENERAL SETUP” with the **CHANNEL** knob.
2. Press the **SELECT** soft key, then rotate the **CHANNEL** knob to select “DISPLAY”.
3. Press the **SELECT** soft key.
4. Rotate the **CHANNEL** knob to select desired screen “NORMAL”, “AIS”, “COMPASS”, “WAYPOINT”, or “GPS STATUS”.
5. Press the **SELECT** soft key to store the selected setting.

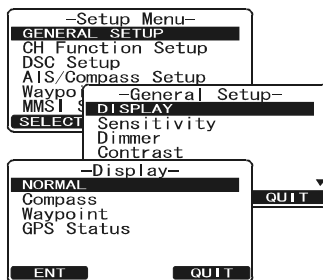

- Press the **QUIT** soft key several times to return to radio operation.

NOTE

To show Position information, show AIS targets and use the Compass display:

GX2150 - external GPS must be connected.

GX2000 - external AIS receiver or transponder and a external GPS must be connected.

8.6 USA, CANADA, AND INTERNATIONAL MODE

To change the channel group from USA to Canada or International:

- Press and hold down the **CALL MENU** key until "Setup Menu" appears.
- Rotate the **CHANNEL** knob to select "CH FUNCTION SETUP".
- Press the **SELECT** soft key, then rotate the **CHANNEL** knob to select "CH GROUP".
- Press the **SELECT** soft key.
- Rotate the **CHANNEL** knob to select desired channel group "USA", "INTL", or "CANADA".
- Press the **ENT** soft key to store the selected setting.
- Press the **QUIT** soft key several times to return to radio operation.

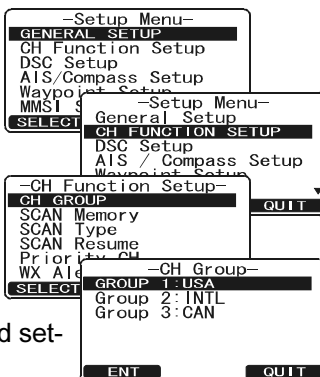

8.7 NOAA WEATHER CHANNELS

- To receive a NOAA weather channel, press and hold the **CLR WX** key for 2 seconds from any channel. The transceiver will go to the last selected weather channel.
- Rotate the **CHANNEL** knob to select a different NOAA weather channel.
- To exit from the NOAA weather channels, press the **CLR WX** key. The transceiver returns to the channel it was on prior to a weather channel.

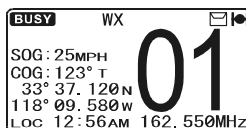

8.7.1 NOAA Weather Alert

In the event of extreme weather disturbances, such as storms and hurricanes, the NOAA (National Oceanic and Atmospheric Administration) sends a weather alert accompanied by a 1050 Hz tone and subsequent weather report on one of the NOAA weather channels.

The **GX2000/GX2150** can receive weather alerts when on a weather channel and on the last selected weather channel during scanning modes or while on another channel.

When an alert is received on a NOAA weather channel, scanning will stop and the transceiver will emit a loud beep to alert the user of a NOAA broadcast. Press any key to stop the alert and receive the weather report. Press the **QUIT** soft key to return to the last selected channel.

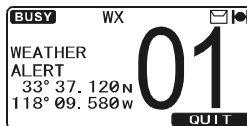

To disable the Weather Alert function, refer to section “11.6 WEATHER ALERT”.

NOTE

If the **CLR WX** key is not pressed the alert will sound for 5 minutes and then the weather report will be received.

8.7.2 NOAA Weather Alert Testing

NOAA tests the alert system every Wednesday between 11AM and 1PM. To test the **GX2000/GX2150**'s NOAA Weather feature, on Wednesday between 11AM and 1PM, setup as in section “8.7.1 NOAA Weather Alert” and confirm the alert is heard.

8.8 DUAL WATCH (TO CHANNEL 16)

Dual watch is used to scan two channels for communications. One channel is a normal VHF channel and the other is the priority, channel 16. When a signal is received on the normal channel the radio briefly switches between the normal channel and Channel 16 to look for a transmission. If the radio receives communications on channel 16 the radio stops and listens to Channel 16 until communication ends and then starts Dual watch scan again.

1. Adjust the **SQL** knob until the background noise disappears.
2. Select the channel you wish to dual watch to the priority channel 16.
3. Press one of the Soft keys, then press the **DW** soft key.

The radio will monitor CH16 and the channel that was selected in step 2.

If a transmission is received on the channel selected in step 2, the **GX2000/GX2150** will dual watch to CH16.

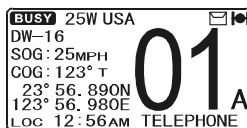

4. To stop Dual Watch, press the one of the soft keys, then press the **[DW]** key soft again.

NOTE

The priority channel may be changed from Ch16 to another channel. Refer to section “11.5 PRIORITY CHANNEL”.

8.9 PRESET CHANNELS (0 ~ 9): INSTANT ACCESS

10 Preset Channels can be programmed for instant access. Press the one of soft keys, then press the **PRESET** soft key to activate the preset channel bank. If the **PRESET** soft is pressed and no channels have been assigned, an alert beep will be emitted from the speaker.

8.9.1 Preset Channel Programming

1. Rotate the **CHANNEL** knob to select the channel to be programmed.
2. Press the one of the soft keys momentarily to indicate these function on the display, then press and hold the **PRESET** soft key until the channel number blinks.
3. Rotate the **CHANNEL** knob to select the desired Preset Channel Position (“SET 0” - “SET 9”) you wish to program.
4. Press the **ADD** soft key momentarily to program the channel into the Preset Channel.
5. Repeat steps 1 through 4 to program the desired channels into Preset Channels “0” ~ “9”.

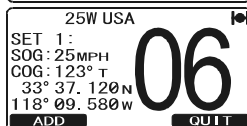
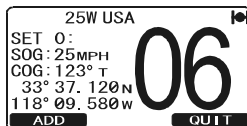

8.9.2 Operation

1. Press the one of soft keys, then press the **PRESET** soft key to recall the Preset Channel. The “P SET” icon will appear on the display.
2. Rotate the **CHANNEL** knob to select the desired Preset Channel (“0” ~ “9”). The Preset Channel number appears (“P-SET0” - “P-SET9”) while selecting the Preset Channel.
3. Press the one of soft keys, then press the **PRESET** soft key again to return to the last selected channel. The “P SET” icon will disappear from the display.

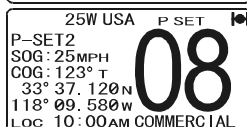

8.9.3 Deleting a Preset Channel

1. Press the one of soft keys, then press the **PRESET** soft key to recall the Preset Channel.
2. Rotate the **CHANNEL** knob to select the Preset Channel to be deleted.
3. Press the one of soft keys, then press and hold the **PRESET** soft key until the channel number is blinking.
4. Press the **DELETE** soft key momentarily to delete the channel from the Preset Channel.

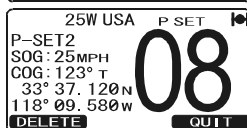
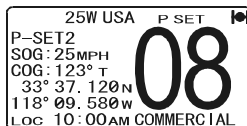

- Repeat steps 2 through 4 to delete the desired channels from Preset Channels "0" ~ "9".
- To finish the deleting the Preset Channel, press the **QUIT** soft key

8.10 SCANNING

The **GX2000/GX2150** will automatically scan channels programmed into Preset Channel Memory and also Scan Channel Memory, and last selected Weather Channel.





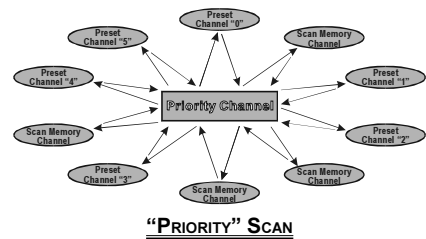
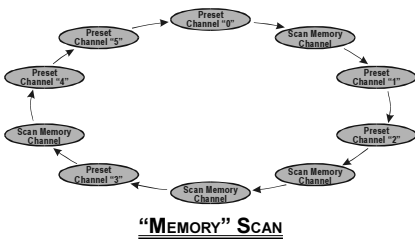
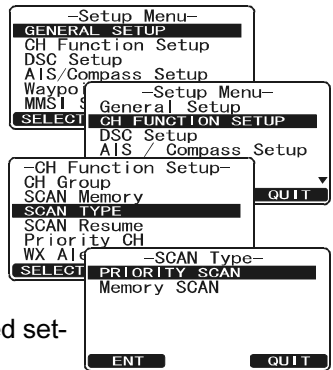

When an incoming signal is detected on one of the channels during scan, the radio will pause on that channel, allowing you to listen to the incoming transmission. The radio will automatically start scanning again after the transmission stops.

8.10.1 Scan Type Selection

- Press and hold down **CALL MENU** key until "Setup Menu" appears.
- Rotate the **CHANNEL** knob to select "CH FUNCTION SETUP".
- Press the **SELECT** soft key, then select "SCAN TYPE" with the **CHANNEL** knob.
- Press the **SELECT** soft key.
- Rotate the **CHANNEL** knob to select "PRIORITY SCAN" or "MEMORY SCAN".
- Press the **SELECT** soft key to store the selected setting.
- Press the **QUIT** soft key several times to return to radio operation.



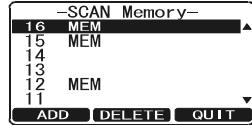
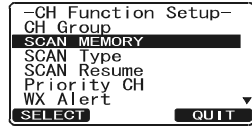
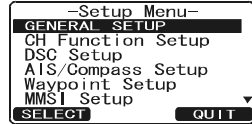

8.10.2 Scan Memory Programming

1. Press and hold down the  key until “Setup Menu” appears.
2. Rotate the **CHANNEL** knob to select “CH FUNCTION SETUP”.
3. Press the  soft key, then rotate the **CHANNEL** knob to select “SCAN MEMORY”.
4. Press the  soft key.
5. Rotate the **CHANNEL** knob to select a desired channel to be scanned, then press the  soft key. “MEM” icon appears on the display, which indicates the channel has been selected to the scan channel.
6. Repeat step 5 for all the desired channels to be scanned.
7. To DELETE a channel from the list, select the channel then press the  soft key. “MEM” icon disappears from the display.
8. When you have completed your selection, press the  soft key several times to return to radio operation.



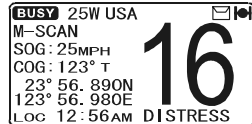

8.10.3 Memory Scanning (M-SCAN)

1. Adjust the **SQL** knob until background noise disappears.
2. Press the one of the soft key momentarily, then press the  soft key. “M-SCAN” appears on the display. Scanning will proceed from the lowest to the highest programmed channel number and Preset channel and will stop on a channel when a transmission is received. The channel number will blink during reception.
3. To stop scanning, press the  or  key.



8.10.4 Priority Scanning (P-SCAN)

In the default setting, Channel 16 is set as the priority channel. You may change the priority channel to the desired channel from Channel 16 by the Radio Setup Mode, refer to section “11.5 PRIORITY CHANNEL”.

1. Adjust the **SQL** knob until background noise disappears.
2. Press the one of the soft key momentarily, then press the  soft key. “P-SCAN” appears on the display. Scanning will proceed between the memorized channels, Preset channel and the Priority channel. The priority channel will be scanned after each programmed channel.
3. To stop scanning, press the  or  key.

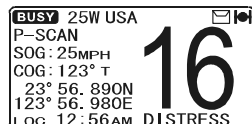

8.11 PA/FOG OPERATION

The **GX2000/GX2150** has a 30W Hailer built-in and can be used with any 4 Ohm PA Horns. Standard Horizon offers a small and a large PA horn called the 220SW and 240SW. When in Hail mode the PA speaker Listen's Back (acts as a microphone and sends sound to the front panel speaker and the speaker mic: **GX2150** only) through the PA horn speaker which provides two-way communications through the PA horn speaker.

NOTE

When in PA or FOG mode, the **GX2000/GX2150** will receive:

1. Communications on the last selected VHF channel before entering into the PA or FOG mode and receive DSC calls.
2. and output AIS signals and the AIS page can be accessed simultaneously.

PA HAIL mode:

PA HAIL mode allows the transceiver to be used as a power hailer when an optional STANDARD HORIZON 220SW or 240SW HAIL/PA speaker is installed. The Hail mode has a listen-back feature (**GX2150** only) which provides two way communication through the HAIL/PA speaker.

FOG HORN mode:

Automatic signaling is transmitted through the HAIL/PA speaker. When the Fog horn, Bells or Whistle signal is not being outputted the **GX2150** listens back through the connected PA Horn speaker (**GX2000** does not have listen back).

8.11.1 PA HAIL Operation

1. Press one of the Soft keys momentarily, then press the **PA/FOG** soft key.

Note: The **NEXT** soft key may have to be pressed to see the **PA/FOG** soft key if the soft keys have not been customized.

2. Rotate the **CHANNEL** knob to select "PA", then press the **SELECT** soft key.
3. Press the **PTT** switch to speak through the HAIL/PA speaker.

Rotate the **CHANNEL** knob to control the AF output level. The AF output level can be set from 0 to 30 watts.

4. To listen back (**GX2150** only), rotate the **PWR/VOL** knob.
5. To exit the PA HAIL mode, press the **CLR** key.

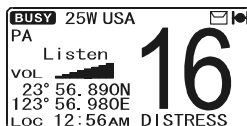



NOTE



When in the PA HAIL mode it is possible to simultaneously use the AIS page by press the  key.

8.11.2 FOG HORN Operation

The user can select from “Underway”, “Stop”, “Sail”, “Tow”, “Aground”, “Anchor”, “Horn”, and “Siren”.

1. Press the one of the soft keys momentarily, then press the  soft key.

Note: The  soft key may have to be pressed to see the  soft key if the soft keys have not be customized.

2. Rotate the **CHANNEL** knob to select “FOG”, then press the  soft key.
3. Rotate the **CHANNEL** knob to select one of the eight functions described above.
4. Press the  soft key.
5. On the “Horn” and “Siren” modes, press the **PTT** switch to activate the tone through the HAIL/PA speaker.

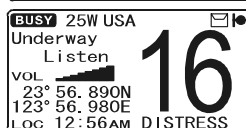
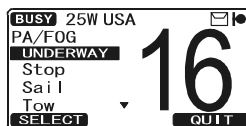

Rotate the **CHANNEL** knob to control the AF output level. The AF output level can be set from 0 to 30 watts.

6. To listen back (**GX2150** only), rotate the **PWR/VOL** knob.
7. To exit the FOG HORN mode, press the  key.

NOTE

When in the FOG HORN mode it is possible to simultaneously use the AIS page by press the  key.

8.11.3 Fog Signal Timing Chart

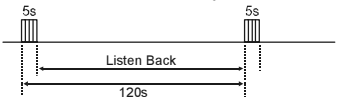
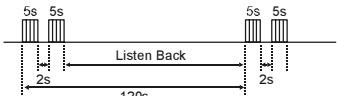
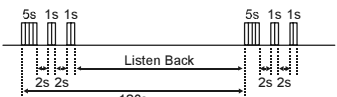
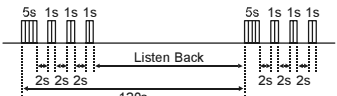
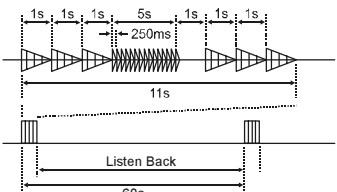
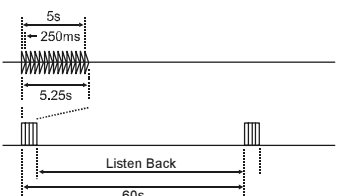
TYPE	PATTERN	
UNDERWAY	<p>One 5-second blasts every 120 seconds.</p> 	Motor vessel underway and making way.
STOP	<p>Two 5-second blasts (separated by 2 seconds) every 120 seconds.</p> 	Motor vessel underway but stopped (not making way).
SAIL	<p>One 5-second blasts followed by two 1-second blasts (separated by 2 seconds) every 120 seconds.</p> 	Sailing vessel underway, fishing vessel (underway or anchored), vessel not under command, a vessel restricted in her ability to maneuver (underway or at anchor), or a vessel towing or pushing another ahead.
TOW	<p>One 5-second blasts followed by three 1-second blasts (separated by 2 seconds) every 120 seconds.</p> 	Vessel under tow (manned).
AGROUND	<p>One 11-second rings every 60 seconds.</p> 	Vessel is aground.
ANCHOR	<p>One 5-second rings every 60 seconds.</p> 	Vessel is at anchor.

8.12 INTERCOM OPERATION

To access the following Intercom functions one of the soft keys must be setup as IC. Refer to section “10.14 SOFT KEYS”.

In addition an optional **RAM3 (CMP30)** Remote Station Microphone must be connected to perform intercom functions between the **GX2000/GX2150** and the **RAM3 (CMP30)**.

8.12.1 Communication

1. Press the one of the soft keys momentarily, then press the **IC** soft key to enable the intercom mode.

Note: Depending on the programming of the **IC** soft key, the **NEXT** soft key may have to be pressed to see the **IC** soft key.

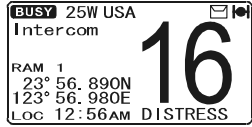

2. When the intercom mode is enabled, “Intercom” is displayed on the radio and **RAM3 (CMP30)** Remote Station Microphone.
3. Press the **PTT** switch on the radio. “Talk” will be shown on the display.

Note: A warning beep will be heard when the Radios **PTT** and **RAM3 (CMP30) PTT** are pushed at the same time.

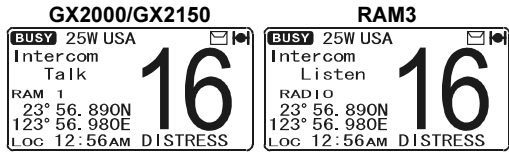

(GX2000/GX2150's PTT switch is pressed)

4. Speak slowly and clearly into the microphone, hold the microphone about 1/2 inch away from your mouth.

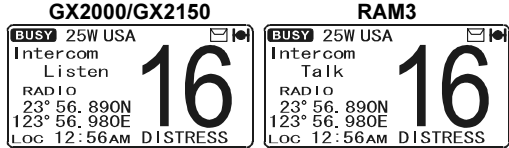

(RAM3's PTT switch is pressed)

5. When finished, release the **PTT** switch.
6. Press the **CLR wx** key to exit intercom mode and revert to radio mode.

8.12.2 Calling

Press and holding the **IC** soft key when in intercom mode on either the **GX2000/GX2150** or **RAM3 (CMP30)** Remote Station Microphone will produce a calling beep to the other station.

8.13 VOICE SCRAMBLER

If privacy of communications is desired, a **CVS2500** 4 code voice scrambler (VS) can be installed in the transceiver. Contact your Dealer to have a **CVS2500** installed. Refer to the section “**11.8 SCRAMBLER SETUP**” to program the voice scrambler.

1. Select a channel that was programmed for scrambler mode (“Vs” and scrambler number will appear on the display).
2. Monitor the channel before transmitting.
3. Transmit the voice message. The signal sent will be scrambled.

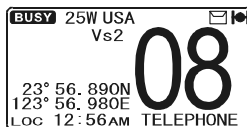

9 DIGITAL SELECTIVE CALLING

9.1 GENERAL

WARNING

This radio is designed to generate a digital maritime distress and safety call to facilitate search and rescue. To be effective as a safety device, this equipment must be used only within communication range of a shore-based VHF marine channel 70 distress and safety watch system. The range of signal may vary but under normal conditions should be approximately 20 nautical miles.

NOTE

A DSC Warning sticker is included with the **GX2000/GX2150**. To comply with FCC regulations this sticker must be mounted in a location that can be easily viewed from the location of the **GX2000/GX2150**.

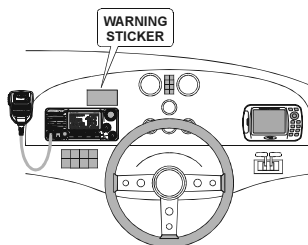

Digital Selective Calling is a semi-automated method of establishing a radio call, it has been designated by the International Maritime Organization (IMO) as an international standard for establishing VHF, MF and HF radio calls. It has also been designated as part of the Global Maritime Distress and Safety System (GMDSS).

Digital Selective Calling allows mariners to instantly send a distress call with GPS position (when connected to the transceiver) to the US Coast Guard and other vessels within range of the transmission. DSC will also allow mariners to initiate or receive Distress, Urgency, Safety, Routine, Position Request, Position Report, Automatic Position Polling and Group calls to or from another vessel equipped with a DSC transceiver.

9.2 MARITIME MOBILE SERVICE IDENTITY (MMSI)

9.2.1 What is an MMSI?

An MMSI is a nine digit number used on Marine Transceivers capable of using Digital Selective Calling (DSC). This number is used like a telephone number to selectively call other vessels.

THIS NUMBER MUST BE PROGRAMMED INTO THE RADIO TO OPERATE DSC FUNCTIONS.

How can I obtain an MMSI assignment?

In the USA, visit the following websites to register:

<http://www.boatus.com/mmsi/> or

http://seatow.com/boating_safety/mmsi.asp

In the Canada, visit









<http://www.ic.gc.ca/epic/site/smt-gst.nsf/en/sf01032e.html> or

<http://www.usps.org/php/mmsi/rules.php>

9.2.2 Programming the MMSI

WARNING

A user MMSI can be inputted only once. Therefore please be careful not to input the incorrect MMSI number. If you need to change the MMSI number after it has been entered, the radio will have to be returned to Factory Service. Refer to the section “16.2 FACTORY SERVICE.”

1. Press and hold down the  key until the “Setup Menu” appears.
2. Rotate the **CHANNEL** knob to select “MMSI SETUP”.
3. Press the  soft key. (To cancel, press the  soft key.)
4. Rotate the **CHANNEL** knob to select the first number of your MMSI, then press the  soft key to step to the next number.
5. Repeat step 4 to set your MMSI number (nine digits).
6. If a mistake was made entering in the MMSI number, press the  soft key until the wrong number is selected, then rotate the **CHANNEL** knob to correct the entry and press the  soft key.
7. When finished programming the MMSI number, press and hold the  soft key. The radio will ask you to input the MMSI number again. Use steps 4 - 6 above.
8. After the second number has been input, press and hold the **CHANNEL** knob to store the MMSI, then press the  soft key to return to radio operation.

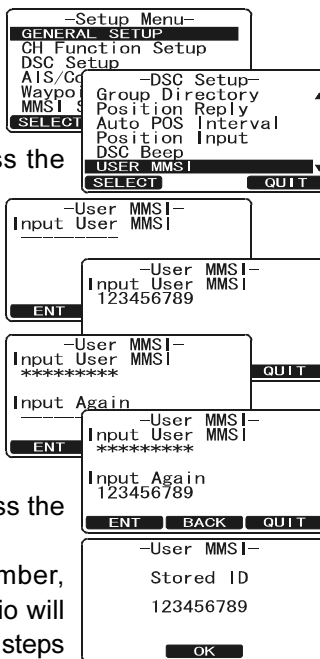

NOTE

To view your MMSI after programming to ensure it is correct, perform steps 1~3. Look that the MMSI number shown on the display is correct.

9.3 DSC DISTRESS ALERT

The **GX2000/GX2150** is capable of transmitting and receiving DSC Distress messages to all DSC radios. The **GX2000/GX2150** may be connected to a GPS to also transmit the Latitude, Longitude of the vessel.

9.3.1 Transmitting a DSC Distress Alert

NOTE

To be able to transmit a DSC Distress Alert an MMSI number must be programmed, refer to section “9.2.2 Programming the MMSI.” In order for your ships location to be transmitted a GPS must be connected to the **GX2000/GX2150**, refer to section “6.5 ACCESSORY CABLE.”

1. Lift the red spring loaded DISTRESS cover and press the **[DISTRESS]** key. The “DISTRESS ALERT” menu will appear on the display.

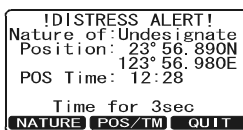

!DISTRESS ALERT!
Nature of:Undesignate
Position: 23° 56.890N
123° 56.980E
POS Time: 12:28
Time for 3sec
NATURE POS/TM QUIT

2. Press and hold the **[DISTRESS]** key. The radios display will count down (3-2-1) and then transmit the Distress Alert. The backlight of the display and keypad flashes while the radios display is counting down.

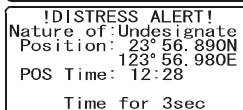

!DISTRESS ALERT!
Nature of:Undesignate
Position: 23° 56.890N
123° 56.980E
POS Time: 12:28
Time for 3sec

3. When the Distress signal is sent, the transceiver watches for a transmission between CH16 and CH70 until an acknowledgment signal is received.

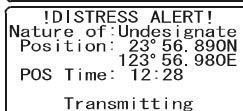

!DISTRESS ALERT!
Nature of:Undesignate
Position: 23° 56.890N
123° 56.980E
POS Time: 12:28
Transmitting

4. If an acknowledgment is received, select channel 16 and advise your distress situation.

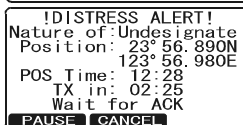

!DISTRESS ALERT!
Nature of:Undesignate
Position: 23° 56.890N
123° 56.980E
POS Time: 12:28
TX in: 02:25
Wait for ACK
PAUSE CANCEL

5. If no acknowledgment is received, the distress call is repeated in 4 minute intervals until a DSC acknowledgment is received.

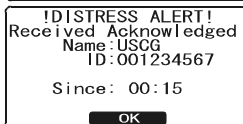

!DISTRESS ALERT!
Received Acknowledged
Name:USCG
ID:001234567
Since: 00:15
OK

6. When a DSC Distress acknowledgment is received, a distress alarm sounds and channel 16 is automatically selected. The display shows the MMSI of the ship responding to your distress.

RECEIVED ACK: acknowledgment signal is received.

RECEIVED RLY: relay signal is received from another vessel or coast station.

7. Press the **PTT** button and state your name, vessel name, number of persons on board and the distress situation, then say over. wait for a reply from the acknowledging ship.

8. To turn off the Distress alarm until the radio retransmits the Distress Alert, press the **(16/9)** key.

9.3.1.1 Transmitting a DSC Distress Alert with Nature of Distress

The **GX2000/GX2150** is capable of transmitting a DSC Distress Alert with the following “Nature of Distress” categories:

Undesignated, Fire, Flooding, Collision, Grounding, Capsizing, Sinking, Adrift, Abandoning, Piracy, MOB

1. Lift the red spring loaded DISTRESS cover and press the **[DISTRESS]** key. The “DISTRESS ALERT” menu will appear on the display.
2. Press the **NATURE** soft key, then rotate the **CHANNEL** knob to select the desired nature of distress category.
3. Press and hold the **[DISTRESS]** key. The radios display will count down (3-2-1) and then transmit the Distress Alert. The backlight of the display and keypad flashes while the radios display is counting down.
4. When the Distress signal is sent, the transceiver watches for a transmission between CH16 and CH70 until an acknowledgment signal is received.
5. If no acknowledgment is received, the DSC distress call is repeated in 4 minute intervals until an acknowledgment is received.
6. When a DSC Distress acknowledgment is received, a distress alarm sounds and channel 16 is automatically selected. The display shows the MMSI of the ship responding to your distress.

RECEIVED ACK: acknowledgment signal is received.

RECEIVED RLY ACK: relay acknowledgment signal is received from another vessel or coast station.

7. Press the **PTT** button and state your name, vessel name, number of persons on board and the distress situation, then say over. wait for a reply from the acknowledging ship.
8. To turn off the Distress alarm until the radio retransmits the Distress Alert, press the **(16/9)** key.

9.3.1.2 Transmitting a DSC Distress Alert with Manual Position of Input

When the **GX2000/GX2150** is not connected to a GPS receiver, you may input the latitude/longitude of your vessel manually and may send DSC Distress Alert.

1. Lift the red spring loaded DISTRESS cover and press the **[DISTRESS]** key. The “DISTRESS ALERT” menu will appear on the display.

!DISTRESS ALERT!
Nature of: Undesignate
Position: 23° 56. 890N
123° 56. 980E
POS Time: 12:28
Time for 3sec
NATURE POS/TM QUIT

!NATURE OF!
UNDIGNATE
Fire
Flooding
Collision
Grounding
Capsizing
SELECT QUIT

!DISTRESS ALERT!
Nature of: Undesignate
Position: 23° 56. 890N
123° 56. 980E
POS Time: 12:28
Time for 3sec

!DISTRESS ALERT!
Nature of: Undesignate
Position: 23° 56. 890N
123° 56. 980E
POS Time: 12:28
Transmitting

!DISTRESS ALERT!
Nature of: Undesignate
Position: 23° 56. 890N
123° 56. 980E
POS Time: 12:28
TX in: 02:25
Wait for ACK
PAUSE CANCEL

!DISTRESS ALERT!
Received Acknowledged
Name: USCG
ID: 001234567
Since: 00:15
OK

- Press the **POS/TM** soft key.
- Enter the latitude/longitude of your vessel and your local UTC time in the 24-hour notation by the **CHANNEL** knob. Rotate the **CHANNEL** knob to select the number and press the **ENT** soft key to move the cursor to the next character. You may backspace the cursor by pressing the **BACK** soft key, if you make a mistake.

```

!DISTRESS ALERT!
Nature of:Undesignate
Position: 23° 56. 890N
          123° 56. 980E
POS Time: 12:28

Time for 3sec
NATURE POS/TM QUIT

```

- When you have completed your selection, press and hold in the **ENT** soft key for two seconds to save the setting.

```

-POS/POS Time Input-
Position: ___° __. ___'
          ___° __. ___'
POS Time: --:-- [UTC]

ENT QUIT

-POS/POS Time Input-
Position: 23° 56. 890N
          123° 56. 980E
POS Time: 12:28 [UTC]

ENT QUIT

```

- Press and hold the **[DISTRESS]** key. The radios display will count down (3-2-1) and then transmit the Distress Alert. The backlight of the display and keypad flashes while the radios display is countdown.

```

!DISTRESS ALERT!
Nature of:Undesignate
Position: 23° 56. 890N
          123° 56. 980E
POS Time: 12:28

Time for 3sec

```

- When the distress signal is sent, the transceiver "shadow-watches" for a transmission between CH16 and CH70 until an acknowledgment signal is received.

```

!DISTRESS ALERT!
Nature of:Undesignate
Position: 23° 56. 890N
          123° 56. 980E
POS Time: 12:28

Transmitting

```

- If no acknowledgment is received, the distress call is repeated in 4 minute intervals until an acknowledgment is received.

```

!DISTRESS ALERT!
Nature of:Undesignate
Position: 23° 56. 890N
          123° 56. 980E
POS Time: 12:28
TX in: 02:25
Wait for ACK

PAUSE CANCEL

```

- When a DSC Distress acknowledgment is received, a distress alarm sounds and channel 16 is automatically selected. The display shows the MMSI of the ship responding to your distress.

```

!DISTRESS ALERT!
Received Acknowledged
Name:USCG
ID:001234567

Since: 00:15

OK

```

RECEIVED ACK: acknowledgment signal is received.

RECEIVED RLY ACK: relay acknowledgment signal is received from another vessel or coast station.

- Press the **PTT** button and state your name, vessel name, number of persons on board and the distress situation, then say over. wait for a reply from the acknowledging ship.
- To turn off the Distress alarm until the radio retransmits the Distress Alert, press the **(16/9)** key.

9.3.1.3 Pausing a DSC Distress Call

After a DSC Distress call is transmitted, the DSC distress call is repeated every 4 minutes until the call is canceled by the user or until the radio is turned on and off again. The **GX2000/GX2150** has provision to suspend (Pause) the retransmitting of the distress call by the procedure below.

1. After the distress call is transmitted, the radio will show the top display to the right.

Looking at this display you will notice TX in: 02:25, this is the time when the radio will re-transmit the DSC distress call.

2. To suspend re-transmitting the DSC call, press the **PAUSE** soft key.
3. To resume counting down to transmit the DSC Distress call, press the **RESUME** soft key.

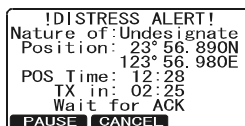

```
!DISTRESS ALERT!  
Nature of:Undesignate  
Position: 23° 56.890N  
          123° 56.980E  
POS Time: 12:28  
TX in: 02:25  
Wait for ACK  
PAUSE CANCEL
```

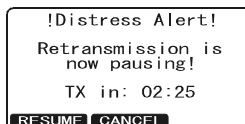

```
!Distress Alert!  
Retransmission is  
now pausing!  
TX in: 02:25  
RESUME CANCEL
```

9.3.1.4 Cancel a DSC Distress Call

If a DSC Distress call was sent by error the **GX2000/GX2150** allows you to send a message to other vessels to cancel the Distress Call that was made.

Press the **CANCEL** soft key, then press **YES** soft key.

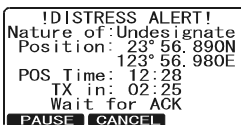

```
!DISTRESS ALERT!  
Nature of:Undesignate  
Position: 23° 56.890N  
          123° 56.980E  
POS Time: 12:28  
TX in: 02:25  
Wait for ACK  
PAUSE CANCEL
```

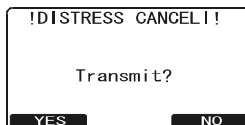

```
!DISTRESS CANCEL!  
  
Transmit?  
YES NO
```

9.3.2 Receiving a DSC Distress Call

1. When a DSC Distress call is received, an emergency alarm sounds.

2. Press any key to stop the alarm.

3. The display shows the position of the vessel in distress. To show additional information of the vessel in distress, rotate the **CHANNEL** knob counter clockwise (refer to the second display).

On the display you will notice 3 soft key selections. These selections are described below:

- a. **ACCEPT**: Accept to auto switching to Channel 16.

Note: If a key is not pressed for 30 seconds or longer the radio will automatically select Channel 16.

- b. **PAUSE**: Temporarily suspend switching to channel 16.

- c. **QUIT**: Exit to the working channel.

4. Press the **WPT** soft key to enter the "Waypoint Input" menu, then enter the desired waypoint name (up to 11 characters), described previously

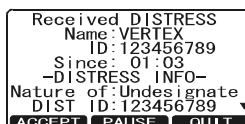

```
Received DISTRESS  
Name:VERTX  
ID:123456789  
Since: 01:03  
-DISTRESS INFO-  
Nature of:Undesignate  
DIST ID:123456789  
ACCEPT PAUSE QUIT
```

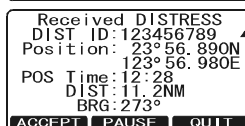

```
Received DISTRESS  
DIST ID:123456789  
Position: 23° 56.890N  
          123° 56.980E  
POS Time: 12:28  
DIST: 11.2NM  
BRG: 273°  
ACCEPT PAUSE QUIT
```

(select the letter/number by rotating the **CHANNEL** knob and move the cursor by pressing the **ENT** / **BACK** soft key).

6. The ID is the MMSI from the vessel in distress.
7. When you are finished entering the waypoint name, press and hold the **ENT** soft key to replace the display to the "WAYPOINT" Screen. The display indicates the distance and direction of the distressed vessel, and also the compass indicates the distressed vessel by dot (●).
8. To stop navigating to a waypoint, press the one of the Soft keys, then press the **STOP** soft key. The radio is switched to Normal Mode.

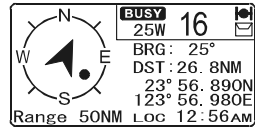
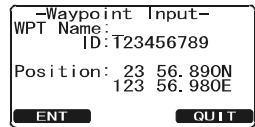
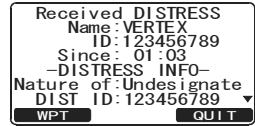

NOTE

You must continue monitoring channel 16 as a coast station may require assistance in the rescue attempt.

9.4 ALL SHIPS CALL

The All Ships Call function allows contact to be established with DSC equipped vessels without having their MMSI in the individual calling directory. Also, priority for the call can be designated as Urgency or Safety.

URGENCY Call: This type of call is used when a vessel may not truly be in distress, but have a potential problem that may lead to a distress situation. This call is the same as saying PAN PAN PAN on channel 16.

SAFETY Call: Used to transmit boating safety information to other vessels. This message usually contains information about an overdue boat, debris in the water, loss of a navigation aid or an important meteorological message. This call is the same as saying Securite, Securite, Securite.”

9.4.1 Transmitting an All Ships Call

1. Press the **CALL MENU** key. The “DSC Menu” will appear.
2. Rotate the **CHANNEL** knob to select “All SHIPS”.
3. Press the **SELECT** soft key. (To cancel, press the **QUIT** soft key.)
4. Rotate the **CHANNEL** knob to select the nature of call (“SAFETY” or “URGENCY”), then press the **SELECT** soft key.
5. Rotate the **CHANNEL** knob to select the operating channel you want to communicate on, then press the **SELECT** soft key. If the channel you want to use is not listed, press the **MANUAL** soft key, then rotate the **CHANNEL** knob to select the operating channel you want to communicate on, then press the **SELECT** soft key.
6. Press the **YES** soft key to transmit the selected type of all ships DSC call.
7. After the All Ships Call is transmitted, the transceiver will switch to the selected channel.
8. Listen to the channel to make sure it is not busy, then key the microphone and say PAN PAN PAN or “Securite, Securite, Securite” depending on the priority of the call.
9. Press the **QUIT** soft key to exit the ALL ship call menu.

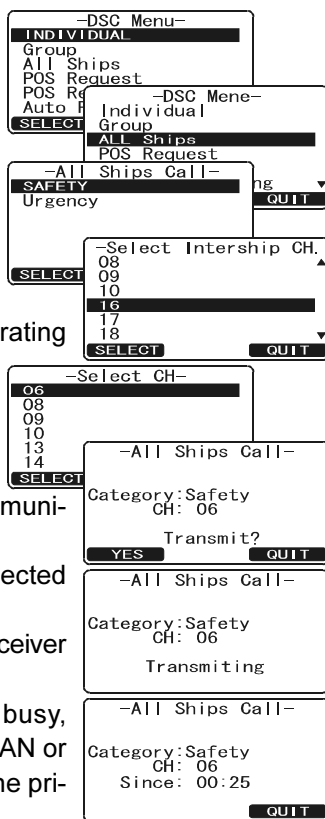

9.4.2 Receiving an All Ships Call

1. When an all ships call is received, an emergency alarm will sound.

The display shows the MMSI of the vessel transmitting the All Ships Call and the radio will change to the requested channel after 10 seconds.

2. Press any key to stop the alarm.
3. Monitor the requested channel until the ALL SHIPs voice communication is completed.

On the display you will notice 3 soft key selections. These selections are described below:

- a. **ACCEPT**: Accept to auto switching to requested channel.

Note: If a key is not pressed for 30 seconds or longer the radio will automatically change to the requested channel.

- b. **PAUSE**: Temporarily suspend switching to the requested channel.
- c. **QUIT**: Exit to the working channel.

4. Press the **QUIT** soft key to return to the channel display.

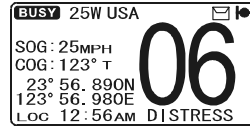

9.5 INDIVIDUAL CALL

This feature allows the **GX2000/GX2150** to contact another vessel with a DSC VHF radio and automatically switch the receiving radio to a desired communications channel. This feature is similar to calling a vessel on CH16 and requesting to go to another channel (switching to the channel is private between the two stations). Up to 80 Individual contacts may be programmed.

9.5.1 Individual / Position Call Directory Setup

The **GX2000/GX2150** has a DSC directory that allows you to store a vessel or person's name and the MMSI number associated with vessels you wish to transmit Individual calls, Auto Polling, Position Request, and Position Report transmissions.

To transmit an Individual call you must program this directory with information of the persons you wish to call, similar to a cellular phones telephone directory.

1. Press and hold down the  key until "Setup Menu" appears.
2. Rotate the **CHANNEL** knob to select "DSC SETUP" menu.
3. Press the **SELECT** soft key, then select "INDIVIDUAL DIRECTORY" with the **CHANNEL** knob.
4. Press the **SELECT** soft key.
5. Select "ADD" with the **CHANNEL** knob, then press the **SELECT** soft key.
6. Rotate the **CHANNEL** knob to scroll through the first letter of the name of the vessel or person you want to reference in the directory.
7. Press the **ENT** soft key to store the first letter in the name and step to the next letter to the right.
8. Repeat step 6 and 7 until the name is complete. The name can consist of up to eleven characters, if you do not use all eleven characters press the **ENT** soft key to move to the next space. This method can also be used to enter a blank space in the name. If a mistake was made entering in the name repeat pressing the **BACK** soft key until the wrong character is selected, then rotate the **CHANNEL** knob to correct the entry.
9. After the eleventh letter or space has been entered, press and hold the **ENT** soft key to advance to the MMSI (Maritime Mobile Service Identity Number) number entry.
10. Rotate the **CHANNEL** knob to scroll through numbers, 0-9. To enter the

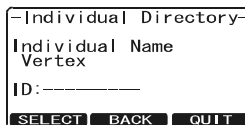
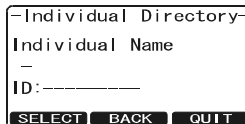
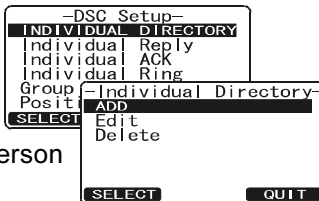
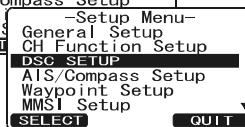
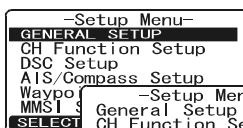

desired number and move one space to the right by pressing the **ENT** soft key. Repeat this procedure until all nine space of the MMSI number are entered.



11. If a mistake was made entering in the MMSI number repeat pressing the **BACK** soft key until the wrong number is selected, then rotate the **CHANNEL** knob to correct the entry.
12. To store the data entered, press and hold the **ENT** soft key.
13. To enter another individual address, repeat steps 5 through 12.
14. Press the **QUIT** soft key several times to return to radio operation.

9.5.2 Individual Reply Setup

This menu item sets up the radio to automatically (default setting) or manually respond to a DSC Individual call requesting you to switch to a working channel for voice communications. When Manual is selected the MMSI of the calling vessel is shown allowing you to see who is calling. This function is similar to caller id on a cellular phone.

1. Press and hold down the **CALL MENU** key until "Setup Menu" appears.
2. Rotate the **CHANNEL** knob to select "DSC SETUP" menu.
3. Press the **SELECT** soft key, then select "INDIVIDUAL REPLY" with the **CHANNEL** knob.
4. Press the **SELECT** soft key.
5. Rotate the **CHANNEL** knob to select "AUTOMATIC" or "MANUAL".
6. Press the **SELECT** soft key to store the selected setting.
7. Press the **QUIT** soft key several times to return to radio operation.

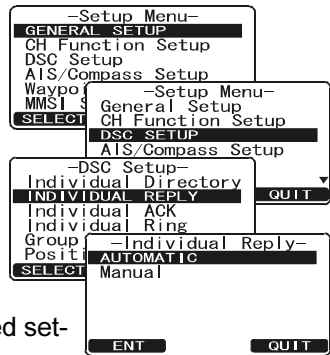

9.5.3 Individual Acknowledgment Setup

The radio can be setup to transmit a reply automatically (default) or set so the radio will not reply to an individual call.

1. Press and hold down the **CALL MENU** key until "Setup Menu" appears.
2. Rotate the **CHANNEL** knob to select "DSC SETUP" menu.
3. Press the **SELECT** soft key, then select "INDIVIDUAL ACK" with the **CHANNEL** knob.
4. Press the **SELECT** soft key.
5. Rotate the **CHANNEL** knob to select "ABLE

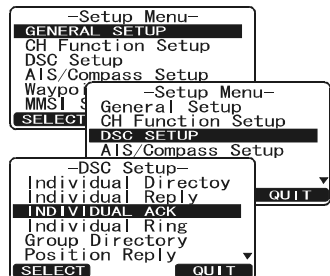

TO COMPLY” or “UNABLE”.

6. Press the **ENT** soft key to store the selected setting, then press the **QUIT** soft key several times to return to radio operation.



9.5.4 Individual/Group Call Ringer Setup

When a Individual Call or Group Call is received the radio will produce a ringing sound for 2 minutes. This selection allows the Individual Call ringer time to be changed.

1. Press and hold down the **CALL MENU** key until “Setup Menu” appears.
2. Rotate the **CHANNEL** knob to select “DSC SETUP” menu.
3. Press the **SELECT** soft key, then select “INDIVIDUAL RING” with the **CHANNEL** knob.
4. Press the **SELECT** soft key.
5. Rotate the **CHANNEL** knob to select ringing time of a Individual Call.
6. Press the **ENT** soft key to store the selected setting, then press the **QUIT** soft key several times to return to radio operation.

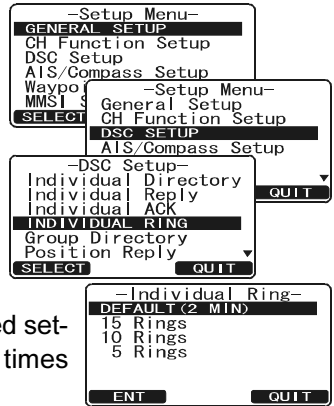

The **GX2000/GX2150** has the capability to turn off the Individual and Group call ringer.

1. Press and hold down the **CALL MENU** key until “Setup Menu” appears.
2. Rotate the **CHANNEL** knob to select “DSC SETUP” menu.
3. Press the **SELECT** soft key, then select “DSC BEEP” with the **CHANNEL** knob.
4. Press the **SELECT** soft key.
5. Rotate the **CHANNEL** knob to select “Individual” if you wish to disable the Individual call ringer, or “Group” if you wish to disable the Group call ringer, then press the **SELECT** soft key.
6. Rotate the **CHANNEL** knob to select “Off”.
7. Press the **ENT** soft key to store the selected setting.
8. Press the **QUIT** soft key several times to return to radio operation.

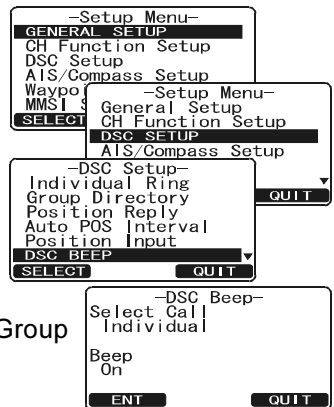

To re-enable the ringer tone, repeat the above procedure, rotating the **CHANNEL** knob to select “On” in step “6” above.

9.5.5 Transmitting an Individual Call

This feature allows the user to contact another vessel with a DSC radio. This feature is similar to calling a vessel on CH16 and requesting to go to another channel.

9.5.5.1 Individual Call using the Individual Directory

1. Press the **CALL MENU** key. The “DSC Menu” will appear.
2. Rotate the **CHANNEL** knob to select “INDIVIDUAL”.
(To cancel, press the **QUIT** soft key.)
3. Press the **SELECT** soft key. The transceiver will beep, and the “Last Individual Call” will appear.

NOTE

To ease making Individual calls, the **GX2000/GX2150** will show the NAME of last Individual call transmitted.

4. Rotate the **CHANNEL** knob to select the “Individual” you want to contact.
5. Press the **SELECT** soft key, then rotate the **CH** knob to select the operating channel you want to communicate on, then press the **SELECT** soft key. If the channel is not shown in the list, press the **MANUAL** soft key, then rotate the **CHANNEL** knob to select the operating channel you want to communicate on, then press the **SELECT** soft key.
6. Press the **YES** soft key to transmit the individual DSC signal.
7. When an individual call acknowledgment is received, the established channel is automatically changed to the channel which is selected on step 5 above and a ringing tone sounds.
8. Press the **QUIT** soft key to listen to the channel to make sure it is not busy, then press the microphone’s **PTT** switch and talk into the microphone to the other vessel.

```
-DSC Menu-
INDIVIDUAL
Group
All Ships
POS Request
POS Report
Auto POS Polling
[SELECT] [QUIT]
```

```
-Individual Call-
HORIZON
BOB
USCG
VERTEX 2
Standard
Sun Lead
[SELECT] [NEW ID] [QUIT]
```

```
-Select Intership CH.
08
09
10
13
14
[SELECT] [MANUAL] [QUIT]
```

```
-Select CH-
08
09
10
16
17
18
[SELECT] [QUIT]
```



```
-Individual Call-
Name: HORIZON
ID: 123456789
Category: Routine
CH: 06
Transmit?
[YES] [QUIT]
```

```
-Individual Call-
Name: HORIZON
ID: 123456789
Category: Routine
CH: 06
Transmitting
```

```
-Individual Call-
Name: HORIZON
ID: 123456789
Category: Routine
CH: 06
Since: 00:25
Waiting For ACK
[QUIT]
```









9.5.5.2 Individual Call by Manually Entering a MMSI

You may enter an MMSI number manually to contact without storing it in the Individual Directory.

1. Press the  key. The “DSC Menu” menu will appear.
2. Rotate the **CHANNEL** knob to select “INDIVIDUAL”.
(To cancel, press the  soft key.)
3. Press the  soft key.

NOTE

If you have transmitted a Individual call before, the radio will show the name of the last person you called as shown in the display at the right. If this is the case press the  soft key and the following steps.

4. Rotate the **CHANNEL** knob to select “MANUAL”, then press the  soft key.
5. Rotate the **CHANNEL** knob to select the first number of the MMSI which you want to contact, then press the  soft key to step to the next number.
6. Repeat step 5 to set the MMSI number (nine digits).
7. If a mistake was made entering in the MMSI number, repeat pressing the  key until the wrong number is selected, then rotate the **CHANNEL** knob to correct the entry.
8. When finished entering the MMSI number, press and hold the  soft key.
9. Press the  soft key, then rotate the **CHANNEL** knob to select the operating channel you want to communicate on, then press the  soft key. If the channel is not shown in the list, press the  soft key, then rotate the **CHANNEL** knob to select the operating channel you want to communicate on, then press the  soft key.
10. Press the  soft key to transmit the individual DSC signal.
11. When an individual call acknowledgment is received, the established channel is automatically changed to the channel which is selected on step 5 above

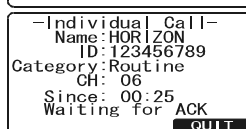
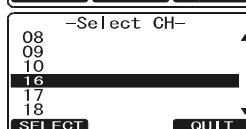
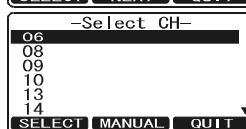
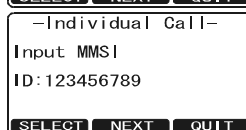
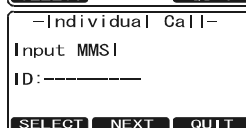
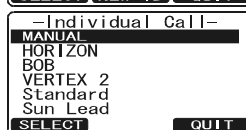
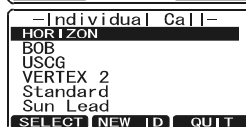
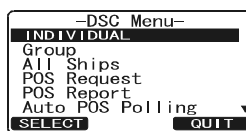

and a ringing tone sounds.

12. Press the **QUIT** soft key to listen to the channel to make sure it is not busy, then press the microphone's **PTT** switch and talk into the microphone to the other vessel.

9.5.6 Receiving an Individual Call

When a Individual DSC call is received, the radio will automatically respond (Default setting) to the calling ship, and switch to the requested channel for voice communications. Refer to section “**9.5.2 Individual Reply Setup**” to change the reply to manual if you want to see who is calling before replying to the call.

1. When an individual call is received, an individual call ringing alarm sounds.

The radio automatically switches to the requested channel. The display shows the MMSI of the vessel calling.



2. Press any key to stop the alarm.
3. Press the **QUIT** soft key to return to radio operation
4. Press the microphone's **PTT** switch and talk into the microphone to the other vessel.

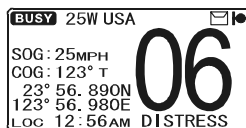

9.6 DSC LOG OPERATION

The **GX2000/GX2150** logs received distress calls and individual calls. The DSC Log feature is similar to an answer machine where calls are recorded for review and a “☒” icon will appear on the radios display. The **GX2000/GX2150** can store up to the latest 26 Distress, and up to the latest 64 other calls (Individual, Group, All Ship etc.).

9.6.1 Reviewing a Logged DSC Distress Call

The **GX2000 / GX2150** radios allows logged DSC distress call to be reviewed.

1. Press the **CALL MENU** key. The “DSC menu” will appear.

2. Rotate the **CHANNEL** knob to select “DSC LOG” menu.

3. Press the **SELECT** soft key, then rotate the **CHANNEL** knob to select “DISTRESS LOG”.

4. Press the **SELECT** soft key, then rotate the **CHANNEL** knob to select the station (name or MMSI number) you want to review and/or relay the distress call to other vessels.

Note: When there is an unread received call, “☒” icon will appear behind the station name (or MMSI number).

5. Press the **SELECT** soft key, to review details for the selected station.

6. Press the **QUIT** soft key to return to radio operation.

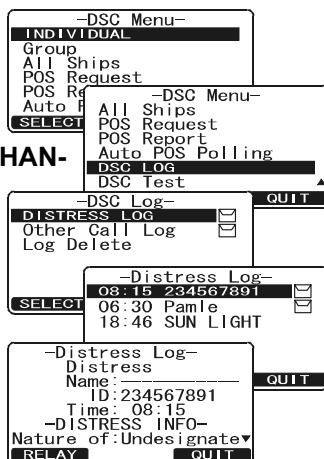

NOTE

Not all DSC radios can receive a DSC distress relay call.

9.6.2 Reviewing a Logged All Ship or Individual Call

Reviewing a logged All ship or Individual call.

1. Press the **CALL MENU** key. The “DSC Menu” will appear.
2. Rotate the **CHANNEL** knob to select “DSC LOG” menu.
3. Press the **SELECT** soft key, then rotate the **CHANNEL** knob to select “OTHER CALL LOG”.
4. Press the **SELECT** soft key, then rotate the **CHANNEL** knob to select the station (name or MMSI number) you want to review and/or call back. When there is an unread received call, “

The image displays a sequence of five screenshots illustrating the menu navigation process for reviewing a logged call. Each screenshot shows a different screen from the radio's interface, with various options and details visible. The first screen shows the main DSC menu with 'DSC LOG' selected. The second screen shows the sub-menu for 'DSC LOG' with 'OTHER CALL LOG' selected. The third screen shows the 'OTHER CALL LOG' sub-menu with 'OTHER CALL LOG' selected. The fourth screen shows the 'OTHER CALL LOG' sub-menu with '08:15 HORAI ZON' selected. The fifth screen shows the details for the selected call, including the name 'Horai zon', ID '345678912', time '08:15', category 'Routine', and channel 'CH: 06'.

9.6.3 Deleting a Call from the “DSC LOG” Directory

1. Press the **CALL MENU** key. The “DSC Menu” will appear.
2. Rotate the **CHANNEL** knob to select “DSC LOG” menu.
3. Press the **SELECT** soft key, then rotate the **CHANNEL** knob to select “LOG DELETE” menu.
4. Press the **SELECT** soft key, then rotate the **CHANNEL** knob to select the category (“DISTRESS LOG” or “OTHER CALL LOG”) to be deleted.
5. Press the **CHANNEL** knob.
 - 1) If you want to delete all stations at a time, select the “ALL LOG DELETE” with the **CHANNEL** knob, then press the **SELECT** soft key, then press the **OK** soft key. Press the **QUIT** soft key several times to return to radio operation.
 - 2) If you want to delete one of the logged stations, select the “VIEW LOG LIST” with the **CHANNEL** knob, then press the **SELECT** soft key. Rotate the **CHANNEL** knob to select the station (name or MMSI number) to be deleted, then press the **DELETE** soft key. The display will show “Are you sure?” press the **OK** soft key.
6. Press the **QUIT** soft key several times to return to radio operation.

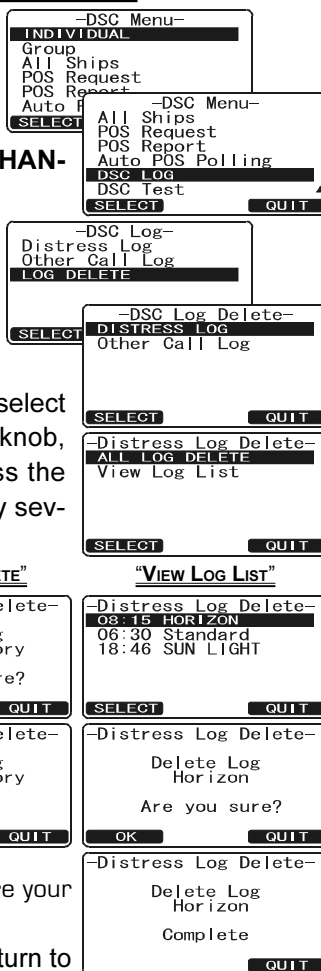

9.7 GROUP CALL

This feature allows the user to contact a group of specific vessels (example members of a yacht club) using DSC radios with Group call function to automatically switch to a desired channel for voice communications. This function is very useful for yacht clubs and vessels traveling together that want to collectively make announcements on a predetermined channel. Up to 32 Group MMSI may be programmed.

9.7.1 Group Call Setup

For this function to operate, the same Group MMSI must be programmed into all the DSC VHF radios within the group of vessels that will be using this feature. To understand Group MMSI programming, first a Ship MMSI has to be understood.

Ship MMSI: The first three digits called a MID (Mobile Identity Group) of a Ship MMSI denote the country the ship registered for a MMSI. The last 6 digits are specific to the Ships ID.

Ship MMSI Example: If your MMSI is “366123456”, “366” is MID which denote the country and “123456” is your ships MMSI.

Group MMSI:

- Group MMSI numbers are not assigned by the FCC or other organizations licensed to assign ship MMSI numbers.
 - The first digit of a Group MMSI is always set to “0” by International rules. All Standard Horizon radios are preset so when programming a Group MMSI the first digit is set to “0”.
 - The USCG recommends programming the MID of a ships MMSI into the Second, Third and Fourth digits of the Group MMSI as it denotes the area the ship is located in.
 - The last 5 digits are decided upon by persons in the Group. This is an important step as all radios in the Group must contain the same Group MMSI so they can be contacted by each other. There is a chance that another group of vessels may program in the same Group MMSI. If this happens, simply change one or more of the last 5 digits of the Group MMSI.
1. Press and hold down the  key until “Setup Menu” appears.
 2. Rotate the **CHANNEL** knob to select “DSC SETUP” menu.
 3. Press the **SELECT** soft key, then select “GROUP DIRECTORY” with the **CHANNEL** knob.
 4. Press the **SELECT** soft key, then select “ADD” with the **CHANNEL** knob.

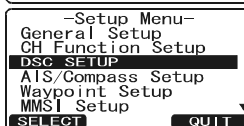
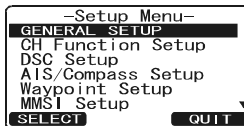

5. Press the **SELECT** soft key.
6. Rotate the **CHANNEL** knob to scroll through the first letter of the name of the group you want to reference in the directory.
7. Press the **SELECT** soft key to store the first letter in the name and step to the next letter to the right.
8. Repeat step 6 and 7 until the name is complete. The name can consist of up to eleven characters, if you do not use all eleven characters press the **SELECT** soft key to move to the next space. This method can also be used to enter a blank space in the name. If a mistake was made entering in the name repeat pressing the **BACK** soft key until the wrong character is selected, then rotate the **CHANNEL** knob to correct the entry.
9. After the eleventh letter or space has been entered, press and hold the **SELECT** soft key to advance to the GROUP MMSI (Maritime Mobile Service Identity Number) number entry.
10. Rotate the **CHANNEL** knob to select the second number of the MMSI (nine digits: first digit permanently set to "0") which you want to contact, then press the **SELECT** soft key to step to the next number. Repeat this procedure until all eight space of the MMSI number are entered.
11. If a mistake was made entering in the MMSI number repeat pressing the **BACK** soft key until the wrong number is selected, then rotate the **CHANNEL** knob to correct the entry.
12. To store the data entered, press and hold the **SELECT** soft key.
13. To enter another group address, repeat steps 5 through 12.
14. Press the **QUIT** soft key several times to return to radio operation.

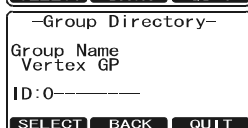
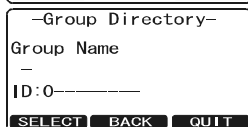

9.7.2 Transmitting a Group Call

9.7.2.1 Group Call using the Individual Directory

1. Press the **CALL MENU** key. The "DSC Menu" will appear.
2. Rotate the **CHANNEL** knob to select "GROUP". (To cancel, press the **QUIT** key.)
3. Press the **SELECT** soft key. The transceiver will beep, and the "Last Group Call" will appear.
4. Rotate the **CHANNEL** knob to select the "Group" you want to contact.
5. Press the **SELECT** soft key, then rotate the **CHAN-**

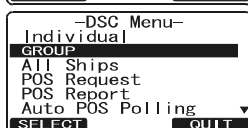
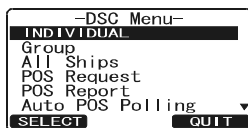

NEL knob to select the operating channel you want to communicate on, then press the **SELECT** soft key. If the channel you want is not shown, press the **MANUAL** soft key, then rotate the **CHANNEL** knob to select the operating channel you want to communicate on, then press the **SELECT** soft key.

6. Press the **YES** soft key to transmit the Group Call signal.
7. When the Group Call signal is sent, the display will be as shown in the illustration at the right.
8. After the Group Call is transmitted, all the radios in the group will switch to the designated channel.
9. Listen to the channel to make sure it is not busy, then press the microphone's **PTT** switch and call the other vessel you desire to communicate with.

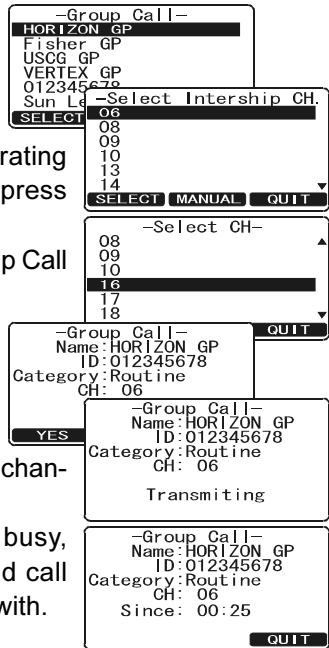

9.7.2.2 Group Call by Manually Entering a MMSI

This feature allows you to contact a group of vessels by entering in their Group MMSI manually.

1. Press the **CALL MENU** key. The “DSC Menu” will appear.
2. Rotate the **CHANNEL** knob to select “GROUP”. (To cancel, press the **QUIT** soft key.)
3. Press the **SELECT** soft key. The transceiver will beep, and the “Last Group Call” will appear.
4. Select “MANUAL” with the **CHANNEL** knob.
5. Press the **SELECT** soft key.
6. Rotate the **CHANNEL** knob to select the first number of the MMSI (nine digits: first digit permanently set to “0”) which you want to contact, then press the **SELECT** soft key to step to the next number.
7. Repeat step 6 to set the MMSI number.
8. If a mistake was made entering in the MMSI

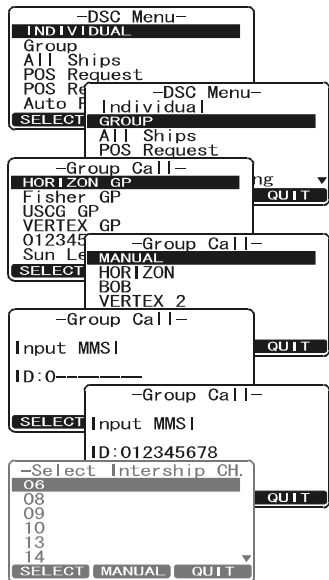

number, repeat pressing the **BACK** soft key until the wrong number is selected, then rotate the **CHANNEL** knob to correct the entry.

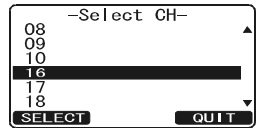

9. When finished entering the MMSI number, press and hold the **SELECT** soft key.
10. Rotate the **CHANNEL** knob to select the operating channel you want to communicate on, then press the **SELECT** soft key. If the channel you want is not shown, press the **MANUAL** soft key, then rotate the **CHANNEL** knob to select the operating channel you want to communicate on, then press the **SELECT** soft key.
11. Press the **YES** soft key to transmit the Group Call signal.
12. After the Group Call is transmitted, all the radios in the group will switch to the designated channel.
13. Listen to the channel to make sure it is not busy, then press the **PTT** button and talk into the microphone to the group of vessels.

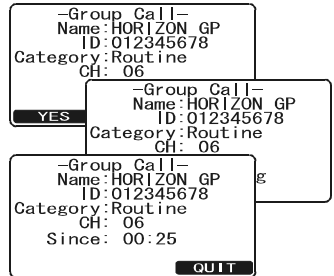

9.7.3 Receiving a Group Call

1. When a group call is received, the **GX2000/GX2150** will produce a ringing alarm sound.
2. The radio will automatically switch to the requested channel.
3. Press the **QUIT** soft key to stop the alarm.
4. Monitor the channel for the person calling the Group for a message.
5. If you want to respond, monitor the channel to make sure it is clear, then press the microphone's **PTT** switch and talk into the microphone to the group of vessels.
6. Press the **QUIT** soft key to return to radio operation.



NOTE

After a Group call is received, the time the call was made and the ships MMSI or vessels name will appear on the display.

9.8 POSITION REQUEST

Advancements in DSC have made it possible to poll the location of another vessel and show the position of that vessel on the display of the **GX2000/GX2150**. Standard Horizon has taken this feature one step further, if any compatible GPS chart plotter is connected to the **GX2000/GX2150**, the polled position of the vessel is shown on the display of the GPS chart plotter making it easy to navigate to the location of the polled vessel. This is a great feature for anyone wanting to know the position of another vessel. For example your buddy that is catching fish, or finding the location of a person you are cruising with.

NOTE

The other vessel must have an operating GPS receiver connected to its DSC radio and must not have its radio set not to deny position requests. (Refer the section “**9.5 INDIVIDUAL CALL**” to enter information into the individual directory).

9.8.1 Position Reply Setup

The **GX2000/GX2150** can be set up to automatically (default setting) or manually send your position when requested by another vessel. This selection is important if you are concerned about someone polling the position of your vessel that you may not want to. In the manual mode you will see the MMSI or persons name shown on the display allowing you to choose to send your position to the requesting vessel.

1. Press and hold down the  key until “Setup Menu” appears.
2. Rotate the **CHANNEL** knob to select “DSC SETUP” menu.
3. Press the **SELECT** soft key, then select “POSITION REPLY” with the **CHANNEL** knob.
4. Press the **SELECT** soft key, then select “AUTOMATIC” or “MANUAL”. In “AUTOMATIC” mode, after a DSC POS Request is received, the radio will automatically transmit your vessels position. In “MANUAL” mode, the display of the **GX2000/GX2150** will show who is requesting the position and the YES soft key on radio has to be pressed to send your position to the requesting.
5. Press the **ENT** soft key to store the selected setting.
6. Press the **QUIT** soft key several times to return to radio operation.

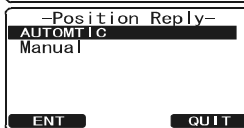
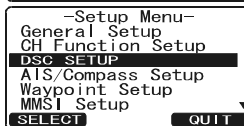
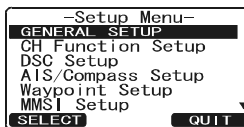

9.8.2 Position Request Ringer Setup

The **GX2000/GX2150** has the capability to turn off the Position Request ringer.

1. Press and hold down the  key until “Setup Menu” appears.
2. Rotate the **CHANNEL** knob to select “DSC SETUP” menu.
3. Press the **SELECT** soft key, then select “DSC BEEP” with the **CHANNEL** knob.
4. Press the **SELECT** soft key, then select “Off” with the **CHANNEL** knob.
5. Press the **ENT** soft key, then select “Off” with the **CHANNEL** knob.
6. Press the **ENT** soft key to store the selected setting.
7. Press the **QUIT** soft key several times to return to radio operation.

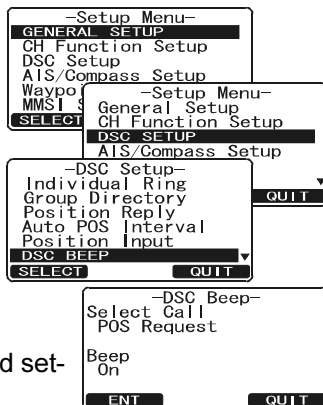

To re-enable the ringer tone, repeat the above procedure, rotating the **CHANNEL** knob to select “On” in step “5” above.

9.8.3 Transmitting a Position Request to Another Vessel

9.8.3.1 Position Request using the Individual Directory

1. Press the  key. The “DSC Menu” will appear.
2. Rotate the **CHANNEL** knob to select “POS REQUEST”.
3. Rotate the **CHANNEL** knob to select a name that was stored in the Individual DSC directory, then press the **SELECT** soft key.
4. Press the **YES** soft key to transmit the Position Request DSC call.
5. When the **GX2000/GX2150** receives the position from the polled vessel it is shown on the radio display and also transferred to a GPS Chart plotter with NMEA DSC and DSE sentences.
6. Press the **QUIT** soft key to return to radio operation.

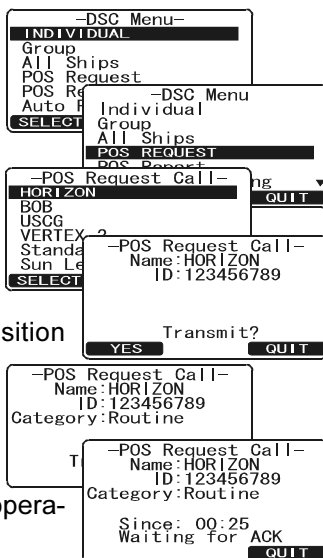

NOTE

If the **GX2000/GX2150** does not receive a position data from the polled vessel, the display will show “NO POSITION DATA.”

9.8.3.2 Position Request by Manually Entering a MMSI

This feature allows you to request the position of vessel by manually entering the MMSI of the ship you want to send your position to.

1. Press the **CALL MENU** key. The “DSC Menu” will appear.
2. Rotate the **CHANNEL** knob to select “POS REQUEST”.
3. Press the **SELECT** soft key to show the “Last Individual Call”.
4. Rotate the **CHANNEL** knob to select the “MANUAL,” then press the **SELECT** soft key.
5. Rotate the **CHANNEL** knob to select the first number of the MMSI (nine digits) which you want to contact, then press the **SELECT** soft key to step to the next number.
6. Repeat step 5 to set the MMSI number.
7. If a mistake was made entering in the MMSI number, repeat pressing the **BACK** soft key until the wrong number is selected, then rotate the **CHANNEL** knob to correct the entry.
8. When finished entering the MMSI number, press and hold the **SELECT** soft key.
9. Press the **YES** soft key to transmit the position request DSC call.
10. When the **GX2000/GX2150** receives the position from the polled vessel it is shown on the radio display and also transferred to the GPS Chart plotter with NMEA DSC and DSE sentences.
11. Press the **QUIT** soft key to return to radio operation.

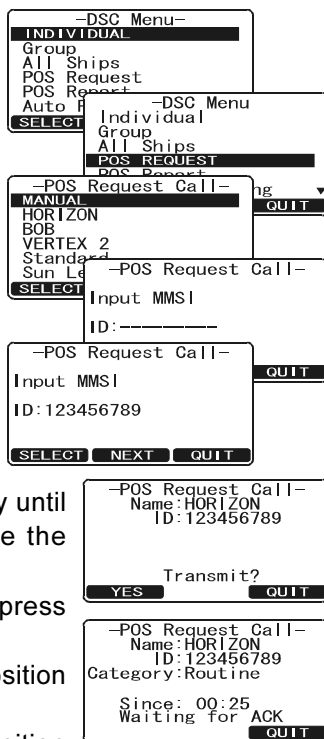

9.8.4 Receiving a Position Request

When a position request call is received from another vessel, a ringing alarm sounds and POS REQUEST will be shown in the display. Operation and transceiver function differs depending on “Position Reply” in the “DSC Setup” menu setting discussed below:

Automatically reply:

1. When a position request call is received, a calling alarm sounds 4 times. Then requested position coordinates are transmitted automatically to the vessel requesting your vessels position.
2. To exit from position request display, press the **QUIT** soft key.



Manually reply:

1. When a position request call is received from another vessel, the display will be as shown in the illustration at the right.
2. A ringing alarm sounds 4 times. To send your vessel's position to the requesting vessel, press the **REPLY** soft key. Or to exit from position request display, press the **QUIT** soft key.

Received POS Request
Name: VERTEX
ID: 123456789
Category: Routine
Since: 01:03
REPLY **QUIT**

POS Reply
Name: VERTEX
ID: 123456789
Category: Routine
Since: 01:03
Transmitted
QUIT

9.9 POSITION REPORT

The feature is similar to Position Request, however instead of requesting a position of another vessel this function allows you to send your position to another vessel. Your vessel must have an operating GPS receiver connected for the **GX2000/GX2150** to send the position.

NOTE

To transmit a Position Report Call, a GPS must be connected to the radio and the **GX2000 / GX2150** Individual directory must be programmed with stations you wish to send your position to. To setup this directory refer to section “9.5.1 Individual / Position Call Directory Setup”.

9.9.1 Setting up a Position Report Ringer

The **GX2000/GX2150** has the capability to turn off the Position Report ringer.

1. Press and hold down the  key until “Setup Menu” appears.
2. Rotate the **CHANNEL** knob to select “DSC SETUP” menu.
3. Press the **SELECT** soft key, then select “DSC BEEP” with the **CHANNEL** knob.
4. Press the **SELECT** soft key, then select “POS Report” with the **CHANNEL** knob.
5. Press the **ENT** soft key, then select “Off” with the **CHANNEL** knob.
6. Press the **ENT** soft key to store the selected setting.
7. Press the **QUIT** soft key several times to return to radio operation.

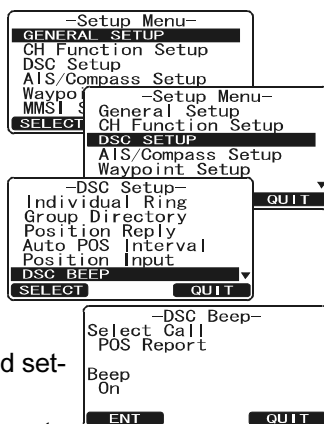

To re-enable the ringer tone, repeat the above procedure, rotating the **CHANNEL** knob to select “On” in step “5” above.

9.9.2 Transmitting a DSC Position Report Call

9.9.2.1 DSC Position Report Call using the Individual Directory

1. Press the  key. The “DSC Menu” will appear.
2. Rotate the **CHANNEL** knob to select “POS REPORT”. (To cancel, press the **QUIT** soft key.)
3. Press the **SELECT** soft key.
4. Rotate the **CHANNEL** knob to select the name in the directory, then press the **SELECT** soft key.

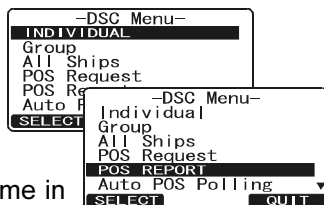

5. Press the **YES** soft key to send your position to the selected vessel.
6. Press the **QUIT** soft key to return to radio operation.

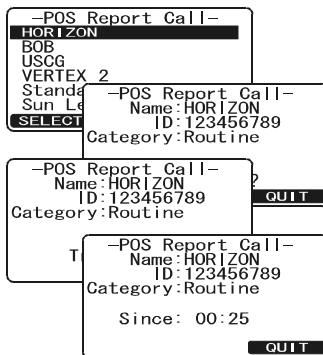

9.9.2.2 DSC Position Report Call manually entering a MMSI

This feature allows you to send your position to another vessel by manually entering the MMSI of the ship you want to send your position to.

1. Press the **CALL MENU** key. The “DSC Menu” will appear.
2. Rotate the **CHANNEL** knob to select “POS REPORT”. (To cancel, press the **QUIT** soft key.)
3. Press the **SELECT** soft key. The transceiver will beep, and the “Position Report Call” menu will appear.
4. Rotate the **CHANNEL** knob to select “MANUAL”, then press the **SELECT** soft key.
5. Rotate the **CHANNEL** knob to select the first number of the MMSI which you want to contact, then press the **SELECT** soft key to step to the next number.
6. Repeat step 5 to set the MMSI number.
7. If a mistake was made entering in the MMSI number, repeat pressing the **BACK** soft key until the wrong number is selected, then rotate the **CHANNEL** knob to correct the entry.
8. When finished entering the MMSI number, press and hold the Press the **SELECT** soft key.
9. Press the **YES** soft key to send your position to the selected vessel.
10. Press the **QUIT** soft key to return to radio operation.

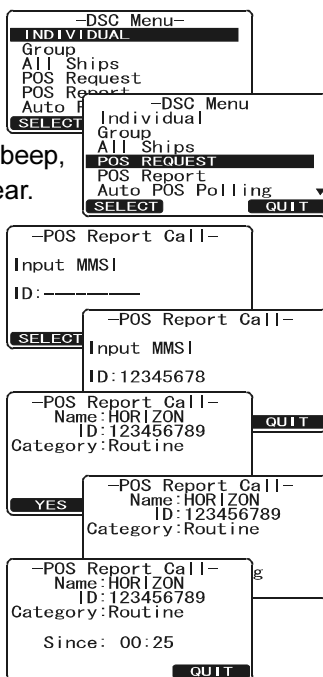

9.9.3 Receiving a DSC Position Report Call

When another vessel transmits their vessels location to the **GX2000/GX2150** the following will happen:

1. A ringing sound will be produced when the call is received and NMEA sentences DSC, DSE are outputted so the position can be shown on a chart plotter or a computer.
2. Press the **CLR** key to stop ringing.
3. Rotate the **CHANNEL** knob to see position information of the station.
4. To exit to radio mode, press the **QUIT** soft key.

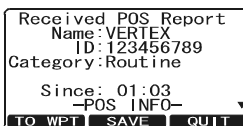

9.9.4 Navigating to a Position Report

The **GX2000/GX2150** has a feature that allows navigation to a received Position Report call by using the Compass display. Navigating to the position of a Position Report call may be enabled by the procedure below.

1. After the Position Report call has been received: press the **TO WPT** soft key.
2. To start navigating using the compass display, press and hold the **ENT** soft key until the Compass Page is shown. The display indicates the distance and direction of the received vessel, and also the compass indicates the received vessel by dot (●).

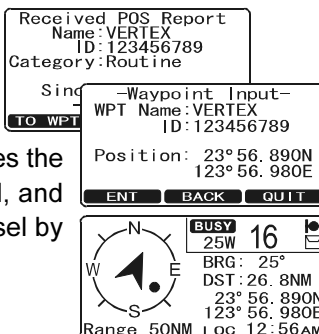

9.9.5 Stop Navigating to a Position Report

To stop navigation and return to the radio mode:

1. Press and hold down the **CALL MENU** key until "Setup Menu" appears.
2. Rotate the **CHANNEL** knob to select "GENERAL SETUP" menu.
3. Press the **SELECT** soft key, then select "DISPLAY" with the **CHANNEL** knob.
4. Press the **SELECT** soft key.
5. Rotate the **CHANNEL** knob to select "NORMAL".
6. Press the **ENT** soft key to return to radio operation.

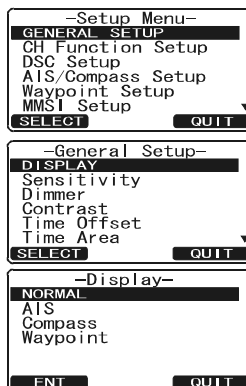

9.9.6 Saving a Position Report as a Waypoint

The **GX2000/GX2150** can save a Position Report call in the radios memory as a waypoint.

1. After the Position Report call has been received: Press the **SAVE** soft key.
2. Rotate the **CHANNEL** knob to change the first letter in the name of the waypoint and press the **ENT** soft key.
3. Repeat step 2 until the WPT Name is entered.
4. Press and hold the **ENT** soft key to save the waypoint into memory.

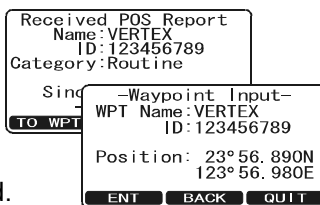

9.9.7 Navigating to a saved waypoint



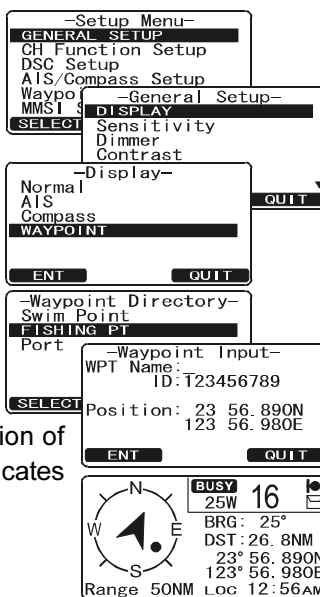



1. Press and hold down the **CALL MENU** key until "Setup Menu" appears.
2. Select "GENERAL SETUP" with the **CHANNEL** knob.
3. Press the **SELECT** soft key, then select "DISPLAY" with the **CHANNEL** knob.
4. Rotate the **CHANNEL** knob to select "WAYPOINT" and press the **ENT** soft key.
5. Rotate the **CHANNEL** knob to select the waypoint name and press the **ENT** soft key.
6. Press the **ENT** soft key so show the compass display and to navigate to the waypoint. The display indicates the distance and direction of the saved waypoint, and also the compass indicates the saved waypoint by dot (●).



9.10 MANUAL INPUTTING OF THE GPS LOCATION (LAT/LON)

You may send the Latitude/Longitude of your vessel manually even if the **GX2000/GX2150** is not connected the GPS receiver unit.

After the position is entered, transmitting a DSC Distress, Position Request, or Position Report will contain the manually entered position.

1. Press and hold down the  key until "Setup Menu" appears.
2. Rotate the **CHANNEL** knob to select "DSC SETUP" menu.
3. Press the  soft key, then select "POSITION INPUT" with the **CHANNEL** knob.
4. Press the  soft key. The transceiver will beep, and the display will be as shown in the illustration on the right.
5. Enter the latitude/longitude of your vessel and your local UTC time in the 24-hour notation by the **CHANNEL** knob. Rotate the **CHANNEL** knob to select the number and press the  soft key to move the cursor to the next character. You may backspace the cursor by pressing the  soft key, if you make a mistake.
6. To store the data entered, press and hold the  soft key.
7. Press the  soft key several times to return to radio operation.

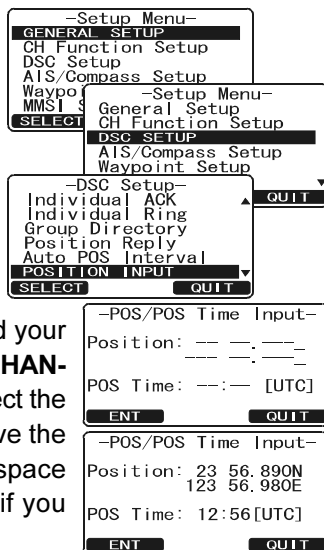

9.11 AUTO DSC POLLING

The **GX2000/GX2150** has the capability to automatically track four stations programmed into the Individual directory.

The following procedure allows the time interval between position requests to be setup.

9.11.1 Polling Time Interval Setup

1. Press and hold down the **CALL MENU** key until “Setup Menu” appears.
2. Rotate the **CHANNEL** knob to select “DSC SETUP” menu.
3. Press the **SELECT** soft key, then select “AUTO DSC INTERVAL” with the **CHANNEL** knob.
4. Rotate the **CHANNEL** knob to select the desired interval time (1,2,3,4,5,10,30 and 40 minutes) and press the **ENT** soft key.
5. Press the **QUIT** soft key numerous times to exit to the radio mode.

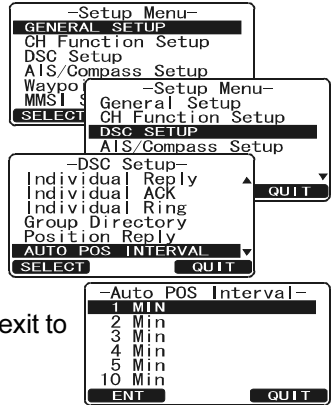

9.11.2 Selecting Stations to be Automatically Polled (tracked)

NOTE

The radio uses the Individual directory to select stations. Refer to section “9.5.1 Individual / Position Call Directory Setup” and to enter MMSI of stations you want to poll before proceeding.

1. Press the **CALL MENU** key. The “DSC Menu” will appear.
2. Rotate the **CHANNEL** knob to select “AUTO POS POLLING”, then press the **SELECT** soft key.
3. Rotate the **CHANNEL** knob to select the “SELECT ADDRESS”, then press the **SELECT** soft key.
4. The radio will show 4 calling stations to be selected, select “CALL 1” and press the **SELECT** soft key.
5. The radio will show the stations programmed in the Individual directory. Rotate the **CHANNEL** knob to select the desired station and press the **SELECT** soft key.
6. Repeat steps 4 and 5 for CALL 2, CALL 3

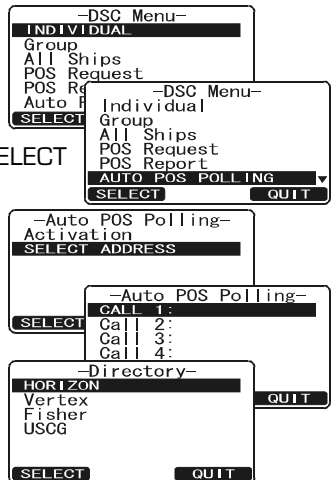

and CALL 4 entries.

- When finished, press the **QUIT** soft key numerous times to exit to the radio mode.

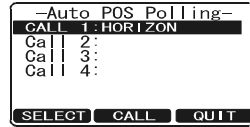

9.11.3 Enable/Disable Auto DSC Polling

- Press the **CALL MENU** key. The “DSC Menu” will appear.
- Rotate the **CHANNEL** knob to select “AUTO POS POLLING”, then press the **SELECT** soft key.
- Rotate the **CHANNEL** knob to select the “ACTIVATION”, then press the **SELECT** soft key.
- Select “START” to enable transmissions to the stations or “STOP” to disable transmissions to stations.
- Press the **ENT** soft key.
- Press the **QUIT** soft key numerous times to exit to the radio mode.

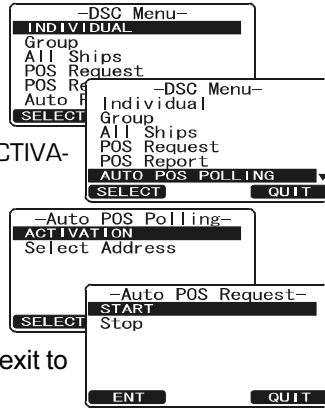

NOTE

When the radio receives position reports from a called vessel the display will show the image to the right and also output NMEA 0183 DSC and DSE sentences to a GPS Chart plotter.

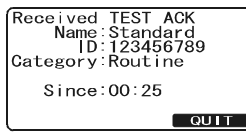

9.12 DSC TEST

This function is used to contact another DSC equipped vessel to ensure the DSC functions of the radio are operating.

NOTE

To use this feature, the radio you will be transmitting the test call to needs to have the DSC Test feature.

To perform the DSC test you will need to enter a MMSI of another vessel into the Individual directory or manually enter in the MMSI using the procedure below.

9.12.1 Programming MMSI into Individual Directory

Refer to section “9.5.1 Individual / Position Call Directory Setup”.

9.12.2 DSC Test call by using the Individual Directory

1. Press the **CALL MENU** key. The “DSC Menu” will appear.
2. Rotate the **CHANNEL** knob to select “DSC TEST”, then press the **SELECT** soft key.
3. Rotate the **CHANNEL** knob to select the Ship name and press the **SELECT** soft key.
4. Press the **YES** soft key to transmit the DSC test call to the other vessel.

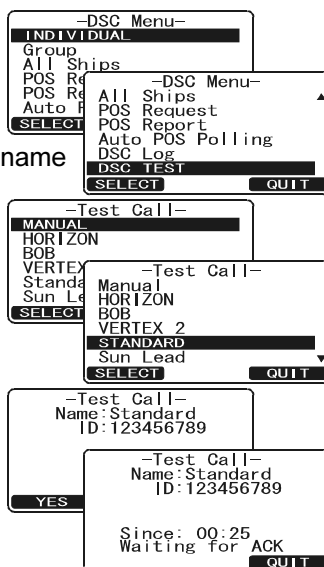

NOTE

After the radio receive a Test Call reply from vessel that was called, the radio will ring and show TEST ACK display, which confirms the radio you called received the test call.

Received TEST ACK
Name: Standard
ID: 123456789
Category: Routine
Since: 00:25
QUIT

9.12.3 DSC Test Call by Manually Entering a MMSI

1. Press the **CALL MENU** key. The “DSC Menu” will appear.
2. Rotate the **CHANNEL** knob to select “DSC TEST”, then press the **SELECT** soft key.
3. Rotate the **CHANNEL** knob to select “MANUAL” and press the **SELECT** soft key.
4. Rotate the **CHANNEL** knob to select the first digit in the MMSI and press the **SELECT** soft key.
5. Repeat step 4 until all the numbers of the MMSI are shown on the display.
6. Press and hold the **SELECT** soft key to show the Test Call page.
7. Press the **YES** soft key to transmit the DSC Test Call to the other vessel.

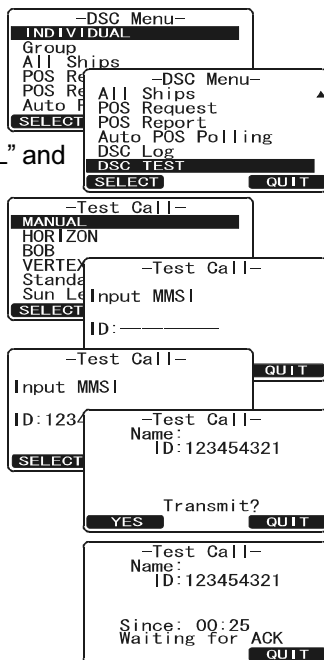

NOTE

After the radio receive a Test Call reply from vessel that was called, the radio will ring and show TEST ACK display, which confirms the radio you called received the test call.

Received AN ACKNOWLEDG
 Name:
 ID: 123456789
 Category: Routine
 Since: 00:25
 We quit wait
QUIT

10 GENERAL SETUP

The optional **RAM3 (CMP30)** Remote Station Microphone can also change the **SETUP** menu using the following procedure.

10.1 DISPLAY

The **GX2000/GX2150** can select additional screens other than the default normal (Radio) display by using the procedure below.

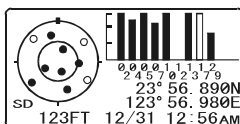
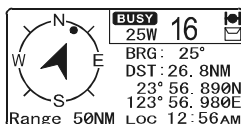
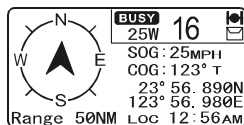
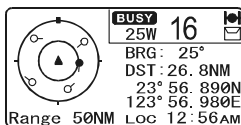
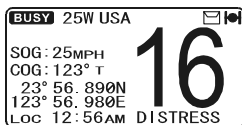

NOTE

1. By default the COG in “NORMAL” and “COMPASS” displays and BRG in “AIS”, “COMPASS”, and “WAYPOINT” displays are set to “True”, however this may be change to magnetic by following the steps in section “10.9 MAGNETIC”.
2. The “GPS STATUS” display is only available on the **GX2150**. For this display to operate correctly, the **GX2150** must be connected to a GPS Chart plotter which outputs NMEA 0183 GSA and GSV sentences.

1. Press and hold down the **CALL MENU** key until “Setup Menu” appears, then select “GENERAL SETUP” with the **CHANNEL** knob.
2. Press the **SELECT** soft key, then rotate the **CHANNEL** knob to select “DISPLAY”.
3. Press the **SELECT** soft key.
4. Rotate the **CHANNEL** knob to select desired screen type “NORMAL”, “AIS”, “COMPASS”, “WAYPOINT”, or “GPS Status”.
5. Press the **SELECT** soft key to store the selected setting.
6. Press the **QUIT** soft key several times to return to radio operation.

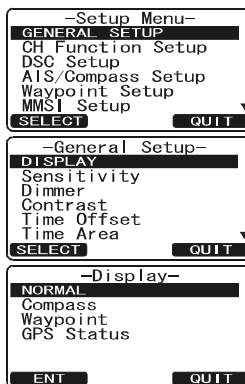

NOTE

To show Position information, show AIS targets and use the Compass display:

GX2150 - external GPS must be connected.

GX2000 - external AIS receiver or transponder and a external GPS must be connected.

10.2 LOCAL DISTANCE RECEIVER ATTENUATOR

In some areas, signals from external sources may cause interference to receiving marine transmissions. The **GX2000/GX2150** has two selections, DISTANCE - used to receive weak signals (default), and LOCAL - which attenuates strong signals that may be interfering with reception.

1. Press and hold down the  key until "Setup Menu" appears.
2. Rotate the **CHANNEL** knob to select "GENERAL SETUP" menu.
3. Press the **SELECT** soft key, then select "SENSITIVITY" with the **CHANNEL** knob.
4. Press the **SELECT** soft key.
5. Rotate the **CHANNEL** knob to select "LOCAL". The receiver sensitivity is now reduced.
6. Press the **ENT** soft key to store the selected level.
7. Press the **QUIT** soft key several times to return to radio operation.

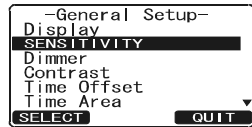
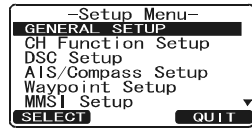

To return to normal sensitivity, repeat the above procedure, rotating the **CHANNEL** knob to select "DISTANCE" in step "5" above.

NOTE

In most cases, DISTANCE mode should be used. If LOCAL is selected, remember the setting should be changed to DISTANCE when navigating away from land to receive weak signals.

10.3 DIMMER ADJUSTING

This menu selection adjusts the backlight intensity.

1. Press and hold down the  key until “Setup Menu” appears.
2. Rotate the **CHANNEL** knob to select “GENERAL SETUP” menu.
3. Press the **SELECT** soft key, then select “DIMMER” with the **CHANNEL** knob.
4. Press the **SELECT** soft key.
5. Rotate the **CHANNEL** knob to select the desired level (“HIGH” is default). When “OFF” is selected, the lamp is turned off.
6. Press the **ENT** soft key to store the selected level.
7. Press the **QUIT** soft key several times to return to radio operation.

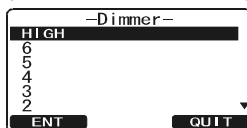
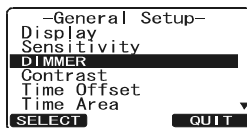
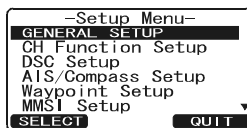

10.4 CONTRAST

Due to varying this selection sets up the display contrast for overhead or dash installations.

1. Press and hold down the  key until “Setup Menu” appears.
2. Rotate the **CHANNEL** knob to select “GENERAL SETUP” menu.
3. Press the **SELECT** soft key, then select “CONTRAST” with the **CHANNEL** knob.
4. Press the **SELECT** soft key.
5. Rotate the **CHANNEL** selector knob to select the desired level. The contrast level can be set from “0” to “31” (“HIGH” is default).
6. Press the **ENT** soft key to store the selected level.
7. Press the **QUIT** soft key several times to return to radio operation.

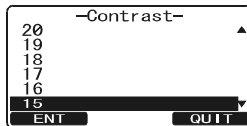
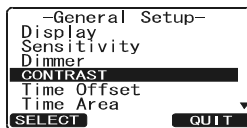
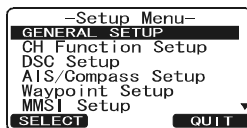

10.5 TIME OFFSET

Sets the time offset between local time (with inputted offset) and UTC (without time offset) shown on the display. Time is displayed only when an optional GPS Chart Plotter is connected.

1. Press and hold down the **CALL MENU** key until “Setup Menu” appears, then select “GENERAL SETUP” with the **CHANNEL** knob.
2. Press the **SELECT** soft key, then select “TIME OFFSET” with the **CHANNEL** knob.
3. Press the **SELECT** soft key, then rotate the **CHANNEL** knob to select time offset of your location. See illustration below to find your offset time. If “00:00” is assigned, the time is the same as UTC (Universal Time Coordinated or GPS Satellite Time).
4. Press the **ENT** soft key to store the time offset.
5. Press the **QUIT** soft key several times to return to radio operation.

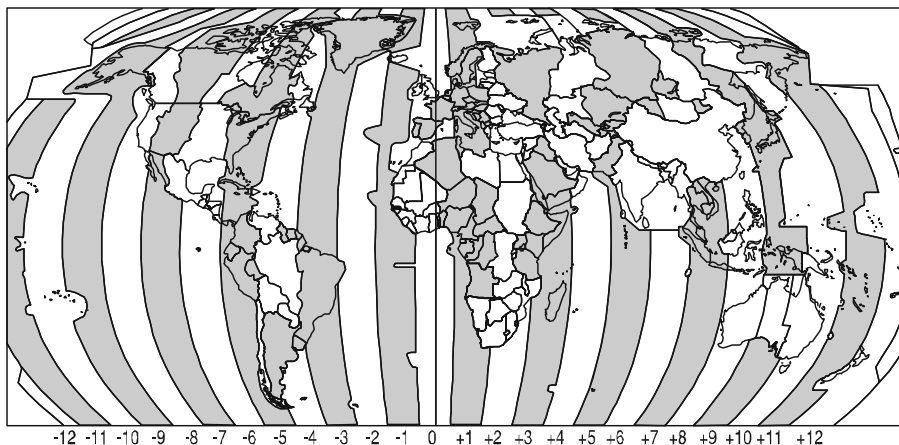
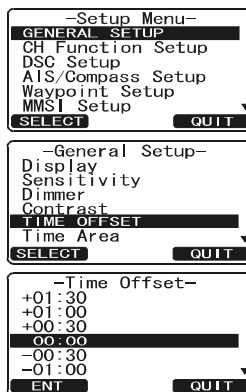

UTC/GMT
OFFSET TIME TABLE

10.6 TIME AREA

This menu selection allows the radio to show UTC time or local time with the offset.

1. Press and hold down the  key until “Setup Menu” appears, then select “GENERAL SETUP” with the **CH** knob.
2. Press the **SELECT** soft key, then rotate the **CHANNEL** knob to “TIME AREA”.
3. Press the **SELECT** soft key.
4. Rotate the **CHANNEL** knob to select “UTC” or “LOCAL”.
5. Press the **ENT** soft key to store the selected setting.
6. Press the **QUIT** soft key several times to return to radio operation.

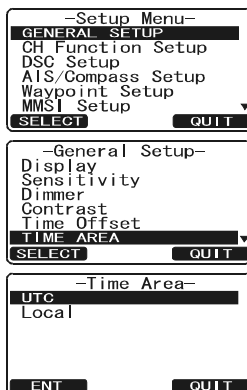

10.7 TIME DISPLAY

This menu selection allows the radio to show time in 12-hour or 24-hour format.

1. Press and hold down the  key until “Setup Menu” appears, then select “GENERAL SETUP” with the **CHANNEL** knob.
2. Press the **SELECT** soft key, then rotate the **CHANNEL** knob to select “TIME DISPLAY”.
3. Press the **SELECT** soft key.
4. Rotate the **CHANNEL** knob to select “12 HOUR” or “24 HOUR”.
5. Press the **ENT** soft key to store the selected setting.
6. Press the **QUIT** soft key several times to return to radio operation.

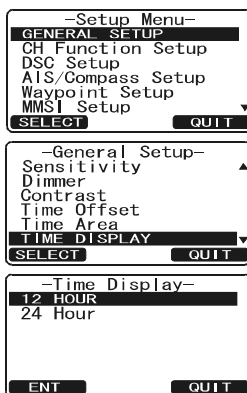

10.8 UNIT OF MEASURE

Allows Navigation and AIS displays to be shown in “Knot”, “Mile/Hour” or “Kilo-Meter/Hour” (for speed) and “Nautical Mile” or “Kilo-Meter” (for distance).

NOTE

A GPS must be connected to the radio to be able to show SPEED and DISTANCE.

1. Press and hold down the  key until “Setup Menu” appears, then select “GENERAL SETUP” with the **CHANNEL** knob.
2. Press the **SELECT** soft key, then rotate the **CHANNEL** knob to select “UNIT OF MEASURE”.
3. Press the **SELECT** soft key.
4. Rotate the **CHANNEL** knob to select “SPEED” or “DISTANCE” which you wish to change.
5. Press the **SELECT** soft key, then rotate the **CHANNEL** knob to select desired unit. Available selections are KTS (knot), MPH (Mile/Hour), or KMH (Kilo-Meter/Hour) for speed, and NH (Nautical Mile) or KM (Kilo-Meter) for distance.
6. Press the **ENT** soft key to store the selected setting.
7. Press the **QUIT** soft key several times to return to radio operation.

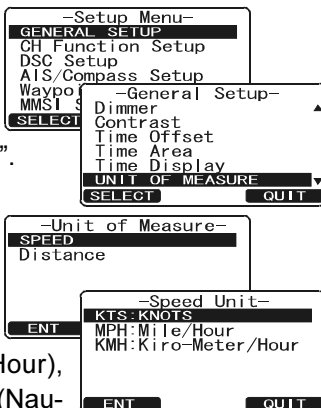

10.9 MAGNETIC

This selection allows customizing COG (Course Over Ground) indication on the Normal and Compass pages and BRG on the Waypoint and AIS pages.

NOTE



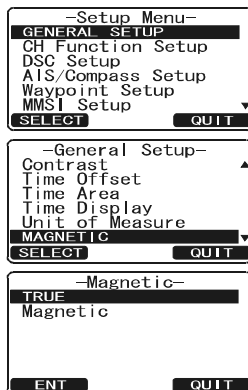

A GPS must be connected to the radio to be able to show COG.

1. Press and hold down the  key until “Setup Menu” appears, then select “GENERAL SETUP” with the **CHANNEL** knob.
2. Press the **SELECT** soft key, then rotate the **CHANNEL** knob to “MAGNETIC”.
3. Press the **SELECT** soft key.
4. Rotate the **CHANNEL** knob to select “TRUE” or “MAGNETIC”.
5. Press the **ENT** soft key to store the selected setting.
6. Press the **QUIT** soft key several times to return to radio operation.



10.10 NMEA DATA IN/OUT



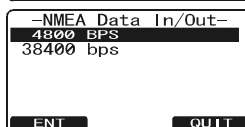
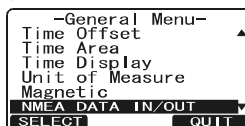
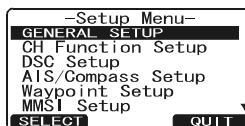

This section is used to setup the NMEA 0183 baud rate of the GPS input (Blue wire) and DSC output (Gray wire). The default setting is 4800 BPS. When 38400 BPS is selected the AIS sentences (VDM) and DSC sentences (DSC & DSE) both are output on the Gray wire after a DSC Distress, Position Request or AIS transmission is received. This Setup Menu works only in **GX2150**.

1. Press and hold down the  key until "Setup Menu" appears, then select "GENERAL SETUP" with the **CHANNEL** knob.
2. Press the  soft key, then rotate the **CHANNEL** knob to select "NMEA DATA IN/OUT".
3. Press the  soft key.
4. Rotate the **CHANNEL** knob to select the desired baud rate.
5. Press the  soft key to store the selected baud rate.
6. Press the  soft several times to return to radio operation.



10.11 KEY BEEP

This selection is used to select the beep tone volume level when a key is pressed.

1. Press and hold down the  key until "Setup Menu" appears, then select "GENERAL SETUP" with the **CHANNEL** knob.
2. Press the  soft key, then rotate the **CHANNEL** knob to select "KEY BEEP".
3. Press the  soft key.
4. Rotate the **CHANNEL** knob to select the desired level. The beep level can be set from "LEVEL 1" to "LEVEL 6", "HIGH", or "OFF".
5. Press the  soft key to store the selected level.
6. Press the  soft several times to return to radio operation.

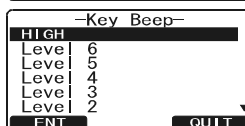
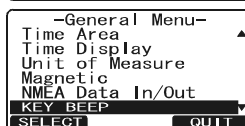
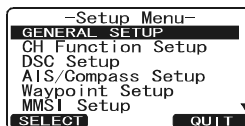

10.12 FOG ALERT TONE FREQUENCY





The function allows the radio to be setup to send the proper fog frequency which is dependant on vessel size, shown below:

70 - 200Hz: Vessel that are 200 meters or more in length

130 - 350Hz: Vessel that are 75 Meters but less than 200 meters or more in length

250 - 525Hz: Vessel that are 66 Feet (20 Meters) but less than 247.5 Feet (75 Meters) in length

250 - 525Hz: Vessel that are 39.6 Feet (12 Meters) but less than 66 Feet (20 Meters) in length

1. Press and hold down the  key until "Setup Menu" appears, then select "GENERAL SETUP" with the **CHANNEL** knob.
2. Press the  soft key, then rotate the **CHANNEL** knob to select "FOG FREQ".
3. Press the  soft key.
4. Rotate the **CHANNEL** knob to select the desired tone frequency.
5. Press the  soft key to store the selected setting.
6. Press the  soft key several times to return to radio operation.

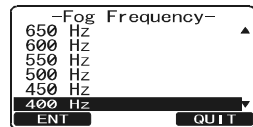
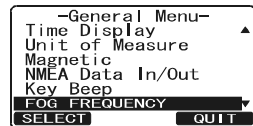
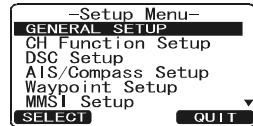

NOTE

By default the radio Fog frequency is set to 400Hz. In most cases this frequency should not be changed unless the vessel is very large.

10.13 STATION NAME

This function allows you to change the name of the radio or second station microphone. Example: "Radio - Cabin", "RAM1 - Flybridge".

1. Press and hold down the  key until "Setup Menu" appears, then select "GENERAL SETUP" with the **CHANNEL** knob.
2. Press the **SELECT** soft key, then rotate the **CHANNEL** knob to select "STATION NAME".
3. Press the **SELECT** soft key.
4. With the second station microphone connected, rotate the **CHANNEL** knob to select the Unit ("Radio" or "RAM1") to be named, then press the **ENT** soft key.
5. Rotate the **CHANNEL** knob to scroll through the first letter of the new channel name.
6. Press the **ENT** soft key to store the first letter in the name and step to the next letter to the right.
7. Repeat step 5 and 6 until the name is complete. The name can consist of up to 8 characters, if you do not use all 8 characters press the **ENT** soft key to move to the next space. This method can also be used to enter a blank space in the name. If a mistake was made entering in the name repeat pressing the **BACK** soft key until the wrong character is selected, then rotate the **CHANNEL** knob to correct the entry.
8. Press and hold the **ENT** soft key to enter the name.
9. If you want to enter the name of the connected **RAM3** or Radio, repeat steps 4 through 8.
10. Press the **QUIT** soft key several times to return to radio operation.

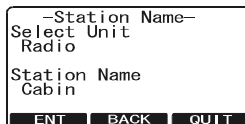
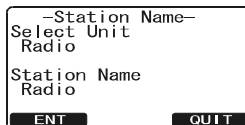
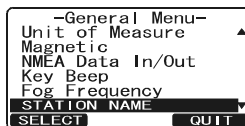
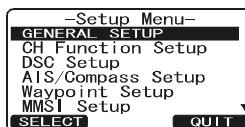

10.14 SOFT KEYS

This menu item allows selection of the number of soft keys, soft key selection and how long the display will show the soft key icon after a soft key is pressed.

10.14.1 Selecting the Number of Soft Keys

1. Press and hold down the  key until "Setup Menu" appears, then select "GENERAL SETUP" with the **CHANNEL** knob.
2. Press the **SELECT** soft key, then rotate the **CHANNEL** knob to "SOFT KEY".
3. Press the **SELECT** soft key, then rotate the **CHANNEL** knob to "NUMBER OF SOFT KEYS".
4. Press the **SELECT** soft key, then rotate the **CHANNEL** knob to select the number of soft keys (3 through 10).
5. Press the **ENT** soft key to store the selected setting.
6. Press the **QUIT** soft key several times to return to radio operation.

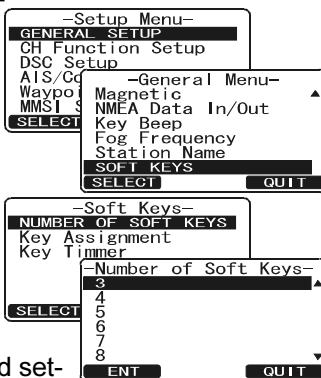





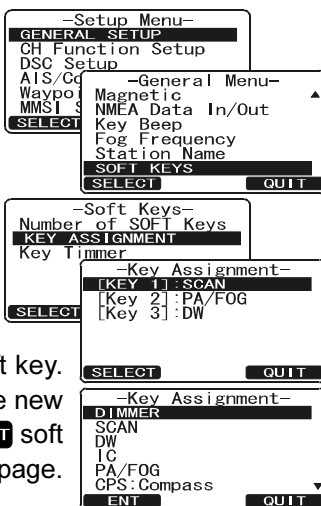

10.14.2 Assigning Soft Keys

1. Press and hold down the  key until "Setup Menu" appears, then select "GENERAL SETUP" with the **CHANNEL** knob.
2. Press the **SELECT** soft key, then rotate the **CHANNEL** knob to "SOFT KEY".
3. Press the **SELECT** soft key, then rotate the **CHANNEL** knob to "KEY ASSIGNMENT" (to change the use of selected soft keys).
4. Press the **SELECT** soft key, then rotate the **CHANNEL** knob to select the key ("KEY1", "KEY2", or "KEY3") and press the **SELECT** soft key. Then, rotate the **CHANNEL** knob to select the new function to be assigned, and press the **SELECT** soft key. Available functions are listed on the next page.
5. Repeat step 4 to program the other soft keys.
The factory defaults are Key 1: **PRESET**, Key 2: **SCAN**, Key 3: **DW**, and Key 4: **PA/FOG**.
6. Press the **ENT** soft key to store the selected setting.
7. Press the **QUIT** soft key several times to return to radio operation.



10.14.3 Selectiong How Long the Soft Keys are Shown

1. Press and hold down the  key until "Setup Menu" appears, then select "GENERAL SETUP" with the **CHANNEL** knob.
2. Press the  soft key, then rotate the **CHANNEL** knob to "SOFT KEY".
3. Press the  key, then rotate the **CHANNEL** knob to select "KEY TIMER" (selects how long the soft key icon will be shown on the display after a soft key is pressed, default is 5 seconds).
4. Press the  soft key, then rotate the **CHANNEL** knob to select the time.
9. Press the  soft key to store the selected setting.
10. Press the  soft key several times to return to radio operation.

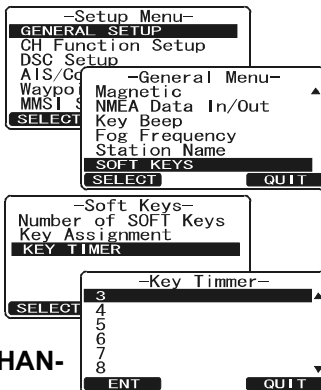

DISPLAY	FUNCTION
DIMMER	Select the menu for the display and key back light intensity
SCAN	Starts and stops Scanning.
DW	Starts and stops Dual Watch Scan.
IC	Activates Intercom between radio and RAM3 mic (optional RAM3 required).
PA/FOG	Activates the PA / Fog Horn function.
CMP: COMPASS	Shows to the "Compass" display.
WPT	Shows to the "Waypoint" Navigation display.
AIS	Shows to the "AIS" display.
AIS AL	Toggles the AIS alarm "on" and "off".
PRESET	Porgrams or deletes the preset memory channel.
MARK	Mark the current position for a "Waypoint".
PSET 0 - PSET 9	Immediately recalls the preset memory channel.

11 CHANNEL FUNCTION SETUP

11.1 CHANNEL GROUP

This section selects a channel group from USA, Canada, and International.

1. Press and hold down the  key until “Setup Menu” appears.
2. Rotate the **CHANNEL** knob to select “CH FUNCTION SETUP”.
3. Press the **SELECT** soft key, then rotate the **CHANNEL** knob to select “CH GROUP”.
4. Press the **SELECT** soft key.
5. Rotate the **CHANNEL** knob to select desired channel group “USA”, “INTL”, or “CANADA”.
6. Press the **ENT** soft key to store the selected setting.
7. Press the **QUIT** soft key several times to return to radio operation.

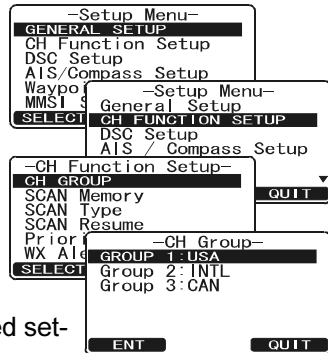

11.2 SCAN MEMORY

To be able to scan channels the radio must be programmed. This section allows channels to be stored in scan memory.

1. Press and hold down the  key until “Setup Menu” appears.
2. Rotate the **CHANNEL** knob to select “CH FUNCTION SETUP”.
3. Press the **SELECT** soft key, then rotate the **CHANNEL** knob to select “SCAN MEMORY CH”.
4. Press the **SELECT** soft key.
5. Rotate the **CHANNEL** knob to select a desired channel to be scanned, then press the **ADD** key. “MEM” icon appears on the display, which indicates the channel has been selected to the scan channel.
6. Repeat step 5 for all the desired channels to be scanned.
7. To DELETE a channel from the list, select the channel then press the **DELETE** key. “MEM” icon disappears from the display.
8. When you have completed your selection, press the **QUIT** soft key several times to return to radio operation.

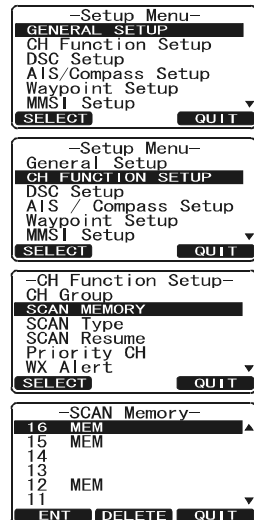

11.3 SCAN TYPE

This selection is used to select the scan mode between “Memory Scan” and “Priority Scan”. The default setting is Priority Scan.

1. Press and hold down the  key until “Setup Menu” appears.
2. Rotate the **CHANNEL** knob to select “CH FUNCTION SETUP”.
3. Press the **SELECT** soft key, then select “SCAN TYPE” with the **CHANNEL** knob.
4. Press the **SELECT** soft key.
5. Rotate the **CHANNEL** knob to select “PRIORITY SCAN” or “MEMORY SCAN”.
6. Press the **ENT** soft key to store the selected setting.
7. Press the **QUIT** soft key several times to return to radio operation.

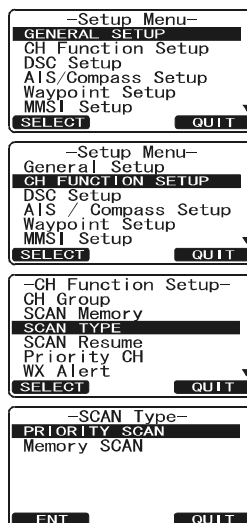

11.4 SCAN RESUME

This selection is used to select the time the **GX2000/GX2150** waits after a transmission ends before the radio start to scan channels again. The default setting is 2 seconds.

1. Press and hold down the  key until “Setup Menu” appears.
2. Rotate the **CHANNEL** knob to select “CH FUNCTION SETUP”.
3. Press the **SELECT** soft key, then select “SCAN RESUME” with the **CHANNEL** knob.
4. Press the **SELECT** soft key.
5. Rotate the **CHANNEL** knob to select the desired resume time, default is 2 seconds. The resume time can be set to “1SEC” through “5SEC”, or “OFF”. In the “OFF” selection, the scanner will resume after the other station stops transmitting (carrier drops).
6. Press the **ENT** soft key to store the selected setting.
7. Press the **QUIT** soft key several times to return to radio operation.

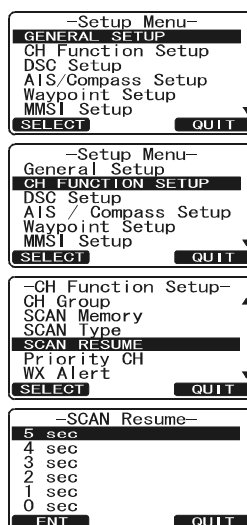

11.5 PRIORITY CHANNEL

By default the radio priority channel is set to channel 16. This procedure allows the radio to use a different priority channel used when priority scanning.

1. Press and hold down the  key until "Setup Menu" appears.
2. Rotate the **CHANNEL** knob to select "CH FUNCTION SETUP".
3. Press the **SELECT** soft key, then select "PRIORITY CH" with the **CHANNEL** knob.
4. Press the **SELECT** soft key.
5. Rotate the **CHANNEL** knob to select the desired channel to be a priority.
6. Press the **ENT** soft key to store the selected setting.
7. Press the **QUIT** soft key several times to return to radio operation.

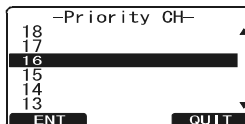
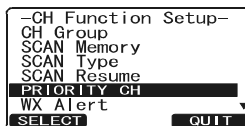
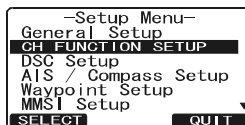
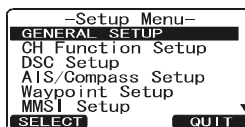

11.6 WEATHER ALERT

Enables/Disables the NOAA Weather Alert function. The default setting is "ON".



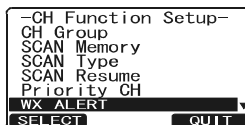
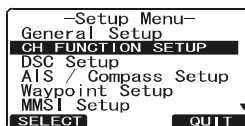
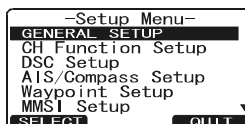





1. Press and hold down the  key until "Setup Menu" appears.
2. Rotate the **CHANNEL** knob to select "CH FUNCTION SETUP".
3. Press the **SELECT** soft key, then select "WX ALERT" with the **CHANNEL** knob.
4. Press the **SELECT** soft key.
5. Rotate the **CHANNEL** knob to select "ON" or "OFF".
6. Press the **ENT** soft key to store the selected setting.
7. Press the **QUIT** soft key several times to return to radio operation.



11.7 CHANNEL NAME

When radio mode (NORMAL) is selected, the display will show a name under the channel number. This name describes the use of the channel. The radio has the capability to customize the name by the procedure below.

Example: CH69 PLEASURE to HOOKUP

1. Press and hold down the  key until "Setup Menu" appears.
2. Rotate the **CHANNEL** knob to select "CH FUNCTION SETUP".
3. Press the  soft key, then select "CH NAME" with the **CHANNEL** knob.
4. Press the  soft key.
5. Rotate the **CHANNEL** knob to select the channel to be named, then press the  soft key.
6. Rotate the **CHANNEL** knob to scroll through the first letter of the new channel name.
7. Press the  soft key to store the first letter in the name and step to the next letter to the right.
8. Repeat step 6 and 7 until the name is complete. The name can consist of up to 16 characters, if you do not use all 16 characters press the  soft key to move to the next space. This method can also be used to enter a blank space in the name. If a mistake was made entering in the name repeat pressing the  key until the wrong character is selected, then rotate the **CHANNEL** knob to correct the entry.
9. Press and hold the  soft key to save the name.
10. If you want to enter the name of another channel, repeat steps 5 through 9.
11. Press the  soft key several times to return to radio operation.

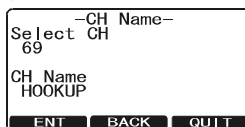
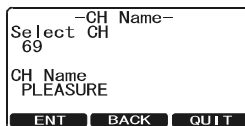
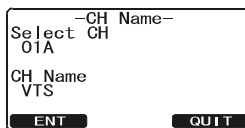
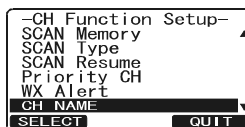
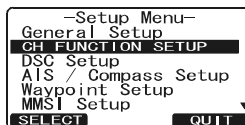
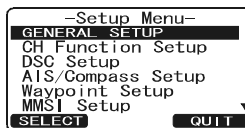

11.8 SCRAMBLER SETUP

NOTE

Operates only when the optional **CVS2500** is installed. This menu will not appear unless a **CVS2500** is installed.

1. Press and hold down the  key until “Setup Menu” appears.
2. Rotate the **CHANNEL** knob to select “CH FUNCTION SETUP”.
3. Press the **SELECT** soft key, then select “SCRAMBLER” with the **CHANNEL** knob.
4. Press the **SELECT** soft key.
5. Rotate the **CHANNEL** knob to select the channel to be scrambled and press the **ENT** soft key.
6. Rotate the **CHANNEL** knob to select the scrambler code. The scrambler code can be set from “0” to “3” and “Off”. When “Off” is selected the voice scrambler is disabled.
7. Press the **ENT** soft key to store the selected code.
8. Repeat steps 5 through 7 to set other channels.
9. Press the **QUIT** soft key several times to return to radio operation.

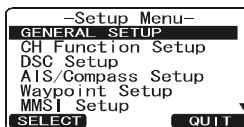

```
-Setup Menu-
GENERAL SETUP
CH Function Setup
DSC Setup
AIS/Compass Setup
Waypoint Setup
MMSI Setup
SELECT QUIT
```

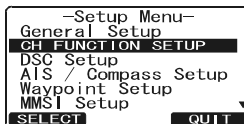

```
-Setup Menu-
General Setup
CH FUNCTION SETUP
DSC Setup
AIS / Compass Setup
Waypoint Setup
MMSI Setup
SELECT QUIT
```

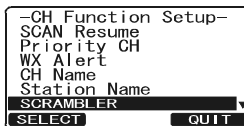

```
-CH Function Setup-
SCAN Resume
Priority CH
WX Alert
CH Name
Station Name
SCRAMBLER
SELECT QUIT
```

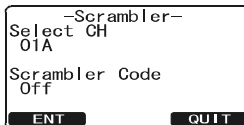









```
-Scrambler-
Select CH
01A
Scrambler Code
Off
ENT QUIT
```

11.9 DEMO MODE

This mode is used by Standard Horizon sales persons and dealers to demonstrate radio, DSC and AIS functions in show rooms or at boat shows. Demo mode allows Latitude, longitude and time to be entered to simulate radio displays. When DEMO mode is enabled, the radio display will automatically switch from NORMAL, COMPASS, AIS and WAYPOINT displays.

NOTE

When demo mode is enabled and the radio is turned off and back on the radio will still be in DEMO mode.

1. Press and hold down the  key until "Setup Menu" appears.
2. Rotate the **CHANNEL** knob to select "DEMO MODE".
3. Press the , then select "POS INPUT" with the **CHANNEL** knob.
4. Press the .
5. Enter the latitude/longitude of your vessel and your local UTC time in the 24-hour notation by the **CHANNEL** knob. Rotate the **CHANNEL** knob to select the number and press the  soft key to move the cursor to the next character. You may backspace the cursor by pressing the , if you make a mistake.
6. To store the data entered, press and hold the  soft key.
7. Rotate the **CHANNEL** selector knob to "DEMO START" and press the  soft key.
8. Select "START" using the **CHANNEL** selector knob and press the  soft key.

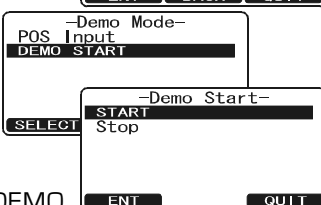
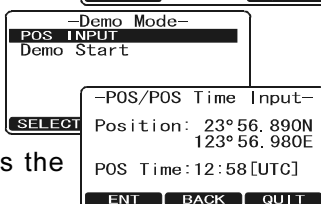
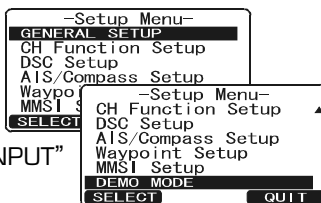

NOTE

To stop DEMO mode, perform steps above, in step 8 select "STOP".

12 DSC SETUP

12.1 INDIVIDUAL DIRECTORY

The **GX2000/GX2150** has a DSC directory that allows you to store a vessel or person's name and the MMSI number associated with vessels you wish to transmit Individual calls, Position Requests and Position Send transmissions.

To transmit an Individual call you must program this directory with information of the persons you wish to call, similar to a cellular phones telephone directory.

Refer to section “**9.5.1 Individual / Position Call Directory Setup**” for programming.

12.2 INDIVIDUAL REPLY

This menu item sets up the radio to automatically (default setting) or manually respond to a DSC Individual call requesting you to switch to a working channel for voice communications. When Manual is selected the MMSI of the calling vessel is shown allowing you to see who is calling. This function is similar to caller id on a cellular phone.

Refer to section “**9.5.2 Individual Reply Setup**” for setting.

12.3 INDIVIDUAL ACKNOWLEDGMENT

The radio can be setup to transmit a reply automatically (default) or set so the radio will not reply to an individual call.

Refer to section “**9.5.3 Individual Acknowledgment Setup**” for setting.

14.4 INDIVIDUAL RINGER

The radio can be setup to ring like a telephone to alert you the radio received a DSC Individual call. The default setting is 2 minutes, however this can be changed to 15, 10 or 5 seconds with the procedure below.

Refer to section “**9.5.4 Individual / Group Call Ringer Setup**” for setting.

14.5 GROUP DIRECTORY

For this function to operate, the same Group MMSI must be programmed into all the DSC VHF radios within the group of vessels that will be using this feature. To understand Group MMSI programming, first a Ship MMSI has to be understood.

Refer to section “**9.7.1 Group Call Setup**” for programming.

14.6 POSITION REPLY

The **GX2000/GX2150** can be set up to automatically (default setting) or manually send your position when requested by another vessel. This selection is important if you are concerned about someone polling the position of your vessel that you may not want to. In the manual mode you will see the MMSI or persons name shown on the display allowing you to choose to send your position to the requesting vessel.

Refer to section “**9.8.1 Position Reply Setup**” for setting.

12.7 AUTO POSITION INTERVAL

The **GX2000/GX2150** has the capability to automatically track four stations programmed into the Individual directory.

Selecting Auto DSC Polling time interval between position request transmissions to be setup.

Refer to section “**9.11 AUTO DSC POLLING**” for setting.

14.8 DSC BEEP

This feature allows the alarm beeps to be turned on (default setting) or off when a DSC call is received. The DSC calls that can be customized are: Individual, Group, All Ships, Position Request, Position Report, Geographic Call using the procedure below:

1. Press and hold down the  key until “Setup Menu” appears.
2. Rotate the **CHANNEL** knob to select “DSC SETUP” menu.
3. Press the **[SELECT]** soft key, then select “DSC BEEP” with the **CHANNEL** knob.
4. Press the **[SELECT]** soft key, then rotate the **CHANNEL** knob to the desired DSC call type and press the **[ENT]** soft key.
5. Rotate the **CHANNEL** knob to turn “On” or “Off” the DSC beep and press the **[ENT]** soft key.
6. Press the **[QUIT]** soft key several times to return to radio operation.

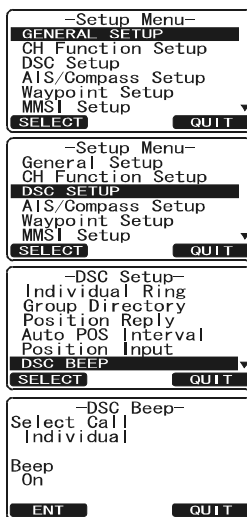

13 AIS/COMPASS SETUP

13.1 AUTOMATIC IDENTIFICATION SYSTEM (AIS)

NOTE

The MATRIX AIS+ **GX2150** does not require a special marine VHF antenna to receive AIS transmissions. The MATRIX AIS+ **GX2150** does not transmit AIS signals, it is NOT recommended to use an antenna dedicated for AIS operation.

The Automatic Identification System (AIS) is a short range coastal tracking system. AIS is intended to assist in collision avoidance by seeing positions and courses of AIS equipped vessels around your vessel.

AIS is mandatory on passenger ships, irrespective of size, all ships 300 gross tonnage and larger engaged on international voyages, cargo ships of 500 gross tonnage and larger not engaged on international voyages.

AIS uses two marine VHF channels. Each ship equipped with an AIS transponder transmits a packet every few seconds with information about the ship and its voyage. Radio frequencies: AIS1 = 161.975 MHz, or channel 87B and AIS2 162.025 MHz, or channel 88B. A stand-alone AIS receiver or the AIS receiver built in to a Class A or Class B transponder can pick up these radio signals and translate them into a NMEA data sentence that can be understood by a computer with the proper software or by an AIS-enabled chart plotter.

Classes of AIS:

Class A - 12.5W power output - mandated for use on SOLAS Chapter V vessels (and others in some countries).

Class B - 2W output - lower cost derivative for leisure and non-SOLAS markets.

The MATRIX AIS+ **GX2150** is capable of receiving Class A and B transmission with the internal Dual Channel AIS receiver. The **GX2000** must be connected to an optional AIS receiver or transponder.

What is the range for AIS receivers?

- Since AIS uses similar VHF frequencies as a marine VHF radio, it has similar radio reception capabilities - which are basically line of sight. This means the higher your VHF antenna is mounted, the greater the reception area will be.
- Reception from Class A vessels that are 20 or even 30 miles away on open water is not uncommon as their antennas are mounted high off the water.
- Class B transponders use lower power for transmissions, therefore you can expect Class B vessels to be received when they are 5 to 10 miles away.

For additional information on AIS visit the USCG web site: <<http://www.navcen.uscg.gov/marcomms/ais.htm>>

13.2 DIRECTION

This function allows you to select the top of the AIS compass to be orientated in Course Up or North Up.

1. Press and hold down the  key until “Setup Menu” appears.
2. Rotate the **CHANNEL** knob to select “AIS/COMPASS SETUP”.
3. Press the **SELECT** soft key, then select “DIRECTION” with the **CHANNEL** knob.
4. Press the **SELECT** soft key.
5. Rotate the **CHANNEL** knob to select “NORTH UP” or “COURSE UP”.
6. Press the **ENT** soft key to store the selected setting.
7. Press the **QUIT** soft key several times to return to radio operation.

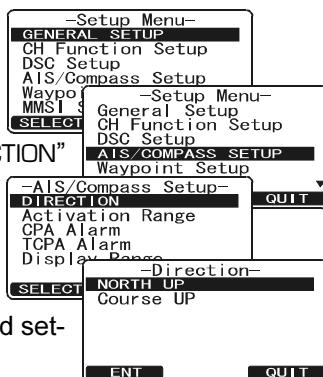

13.3 ACTIVATION RANGE

This function allows you to set the range the **GX2150** AIS receiver, or **GX2000** with AIS input searches for targets. The default setting is 10NM.

1. Press and hold down the  key until “Setup Menu” appears.
2. Rotate the **CHANNEL** knob to select “AIS/COMPASS SETUP”.
3. Press the **SELECT** soft key, then select “ACTIVATION RANGE” with the **CHANNEL** knob.
4. Press the **SELECT** soft key.
5. Rotate the **CHANNEL** knob to select the desired range.
6. Press the **ENT** soft key to store the selected setting.
7. Press the **QUIT** soft key several times to return to radio operation.

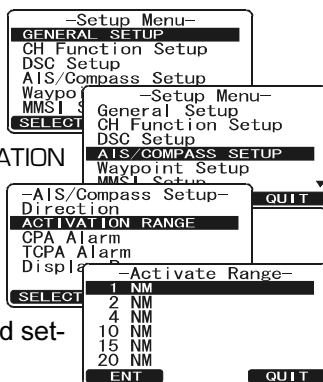

13.4 CPA ALARM

This function allows you to set the CPA (Closest Point of Approach)* alarm distance.

※: CPA means the positions at which two moving vessels reach their closest possible distance.

1. Press and hold down the  key until “Setup Menu” appears.
2. Rotate the **CHANNEL** knob to select “AIS/COMPASS SETUP”.
3. Press the **SELECT** soft key, then select “CPA ALARM” with the **CHANNEL** knob.
4. Press the **SELECT** soft key.
5. Rotate the **CHANNEL** knob to select the distance you want the radio to alert you of an approaching AIS fitted vessel.
6. Press the **ENT** soft key, then rotate the **CHANNEL** knob to set the Alarm item to “On”.
7. Press the **ENT** soft key to store the selected setting.
8. Press the **QUIT** soft key several times to return to radio operation.

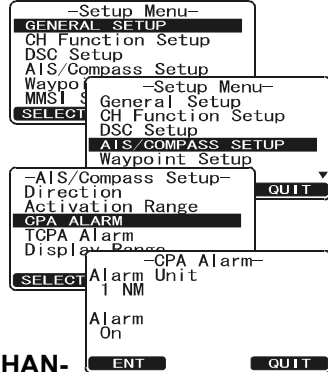

NOTE

The alarm will sound until it is disabled (1) by pressing any key, (2) following the steps above and in step 6 select “Off” or (3) when the ship is out of the selected CPA alarm distance. The alarm is produced from the front panel speaker, speaker in the mic, the optional external speaker and optional **RAM3** mic when connected.

13.5 TCPA ALARM

This function allows you to set the TCPA (Time to Closest Point of Approach)* time alarm.

※: Setting up a TCPA alarm sets a time point where the radio will alarm when an AIS equipped vessel approaching within the time selected.

1. Press and hold down the  key until “Setup Menu” appears.
2. Rotate the **CHANNEL** knob to select “AIS/COMPASS SETUP”.
3. Press the **SELECT** soft key, then select “TCPA ALARM” with the **CHANNEL** knob.

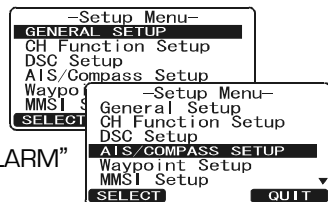

4. Press the **SELECT** soft key.
5. Rotate the **CHANNEL** knob to select the time that the TCPA alarm will sound.
6. Press the **ENT** soft key, then rotate the **CHANNEL** knob to set the Alarm item to "On".
7. Press the **ENT** soft key to store the selected setting.
8. Press the **QUIT** soft key several times to return to radio operation.

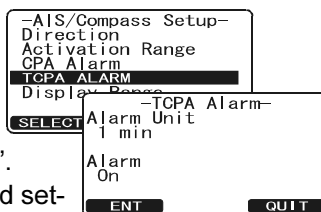

NOTE

The alarm will sound until it is disabled (1) by pressing any key, (2) following the steps above and in step 6 select "Off" or (3) when the ship is out of the selected TCPA alarm time. The alarm is produced from the front panel speaker, speaker in the mic, the optional external speaker and optional **RAM3** mic when connected.

13.6 DISPLAY RANGE

The radio can show AIS targets on the display. This menu item allows setting of the range rings on the display. The default setting is 15NM.

NOTE

A GPS must be connected to the radio to show AIS targets.

1. Press and hold down the **CALL MENU** key until "Setup Menu" appears.
2. Rotate the **CHANNEL** knob to select "AIS/COMPASS SETUP".
3. Press the **SELECT** soft key, then select "DISPLAY RANGE" with the **CHANNEL** knob.
4. Press the **SELECT** soft key.
5. Rotate the **CHANNEL** knob to select the desired range. Available range selections are 0.5, 1.0, 2, 5, 10 and 15NM.
6. Press the **ENT** soft key to store the selected setting.
7. Press the **QUIT** soft key several times to return to radio operation.

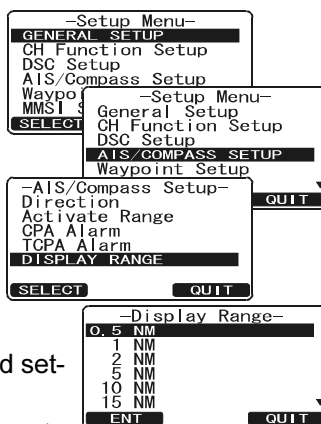

NOTE

When the AIS page is shown, pressing one of the Soft keys will show a **RANGE** soft key. Press this key and move the **CHANNEL** knob to change the range.

13.7 AIS OPERATION

The **GX2150** is equipped with an AIS (AUTOMATIC IDENTIFICATION SYSTEM) receiver and can display AIS targets around your vessel on the radios display. Therefore, you can identify and avoid other large vessels nearby your vessel.

The **GX2000** can also show AIS targets, however a separate AIS receiver or transponder with NMEA VDM 34800 baud must be connected to the accessory cable.

NOTE

To show AIS targets on radios display, a GPS needs to be connected so the radio knows its position relative to the AIS targets.

1. Press the **AIS** key to show the AIS screen. The AIS display shows your vessel as a triangle in the center of the display. AIS targets are shown as circles. The line projected from the circle is the AIS vessels course over ground (COG).

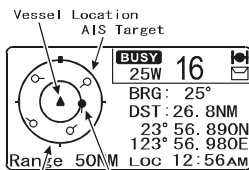

2. Press the one of the soft keys momentarily, then press the **LIST** soft key to show a list of AIS vessels being received.

Note: Up to 10 AIS targets can be shown on the display.

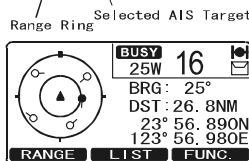

3. Rotate the **CHANNEL** knob to select the MMSI number (or vessel name). The selected AIS target is displayed with “↓” icon, other station is displayed with “○” icon.



4. Press the one of the soft key momentarily, then press the **INFO** key to show more information of the AIS target.

Note: When the “LIST” and “INFO” pages are shown, the radio will update every ten seconds, so it may take some time to show the vessels names instead of the MMSI and update the navigation information of each ship. The AIS output of the **GX2150** is updated in realtime as transmissions are received from the AIS equipped ships.

5. To see AIS information of another AIS target, press the **NEXT** key. Repeat presses of the **NEXT** key will scroll through all the AIS Targets.

13.7.1 Transmitting and Individual Call to an AIS Ship

It is possible for the **GX2000** or **GX2150** to transmit a DSC Individual call to a received AIS target by the procedure below:

1. Press the one of the soft keys momentarily, then press the **CALL** soft key.
2. Rotate the **CHANNEL** knob to select the operating channel you want to communicate on and press the **CHANNEL** knob. If the channel you want is not shown, press the **MANUAL** soft key, then rotate the **CHANNEL** knob to select the operating channel you want to communicate on, then press the **CHANNEL** knob.
3. To transmit a Individual DSC call to the select AIS ship, press the **CHANNEL** knob again. After the **GX2000** (when connected to an external AIS) or **GX2150** transmits, the radio waits for the DSC radio on the AIS ship to transmit an reply, at which time the radio will ring like a telephone. Pick up the mic and press the **PTT** and hail the AIS vessel.
4. Press the **QUIT** soft key to return to AIS screen.
5. Press the **AIS** key to return to radio screen.

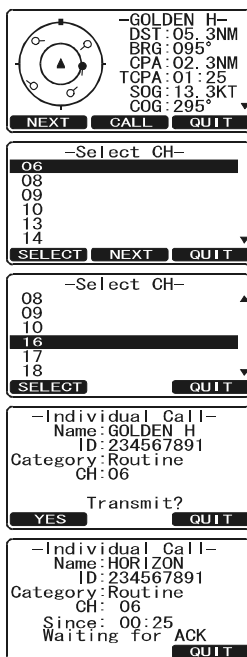

13.8 AIS RANGE

You may change the display range of the AIS screen.

Press the one of the soft key momentarily, then press the **RANGE** key to display the range selection screen. Rotate the **CHANNEL** knob to select the desired range and **ENT** soft key to save the new range.

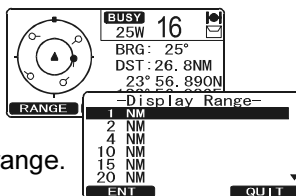

NOTE

You may change the display range unit of the AIS screen, refer to section **"10.8 UNIT OF MEASURE"**.









14 WAYPOINTS

The **GX2000/GX2150** is capable of storing up to 100 waypoint and navigating to them using the compass page.

In addition DSC distress calls with position or a position received from another DSC radio using DSC polling can be navigated to.







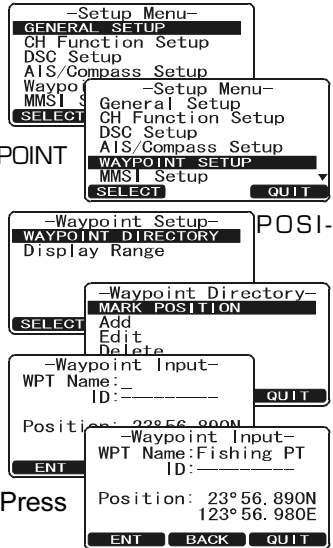





14.1 MARKING A POSITION

This feature allows the radio to mark the current position of the vessel.

1. Press and hold down the  key until "Setup Menu" appears.
2. Rotate the **CHANNEL** knob to select "WAYPOINT SETUP".
3. Press the  soft key, then select "WAYPOINT DIRECTORY" with the **CHANNEL** knob.
4. Press the  soft key, then select "MARK POSITION" with the **CHANNEL** knob.
5. Press the  soft key, then enter the Waypoint Name, by rotating the **CHANNEL** knob to select the first letter.
6. Press the  soft key to store the first letter and to move to the second letter in the name.
7. Repeat step 5 and 6 until the name is shown. Press the  soft key to skip a letter if needed.
8. Press and hold the  soft key two times to save the waypoint into memory.
9. Press the  soft key several times to return to radio operation.



14.2 ADDING A WAYPOINT

1. Press and hold down the  key until "Setup Menu" appears.
2. Rotate the **CHANNEL** knob to select "WAYPOINT SETUP".
3. Press the  soft key, then select "WAYPOINT DIRECTORY" with the **CHANNEL** knob.
4. Press the  soft key, then select "ADD" with the **CHANNEL** knob.
5. Press the  soft key.
6. Enter the Waypoint Name, by rotating the **CHANNEL** knob to select the first letter.
7. Press the  soft key to store the first letter and to move to the second letter in the name.
8. Repeat step 5 and 6 until the name is shown. Press the  soft key to skip a letter if needed.
9. Press and hold the  soft key, then enter the coordinates of the waypoint POSITION, by rotating the **CHANNEL** knob to select the first digit in the Latitude.
10. Press the  soft key to store the first number and to move to the second number in the position.
11. Repeat step 9 and 10 until the latitude is shown include N or S in the last digit.
12. Press the  soft key to select the first digit of the Longitude is blinking.
13. Rotate the **CHANNEL** knob to select the first digit in the Longitude.
14. Press the  soft key to store the first number and to move to the second number in the position.
15. Repeat step 13 and 14 until the Latitude is shown include E or W in the last digit.
16. After all information is entered, press and hold the  soft key to store the waypoint into memory.
17. Press the  soft key several times to return to radio operation.

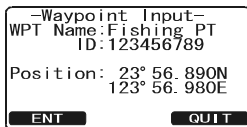
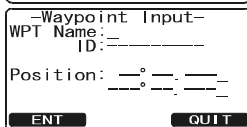
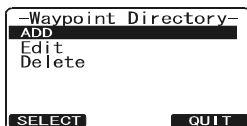
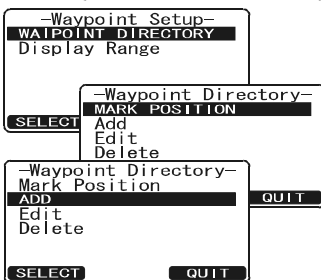
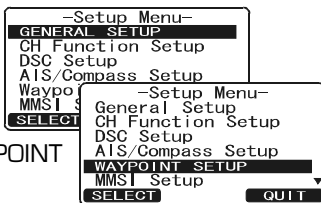

14.3 EDITING A WAYPOINT

This function allows a previously entered waypoint to be edited.

1. Press and hold down the  key until “Setup Menu” appears.
2. Rotate the **CHANNEL** knob to select “WAYPOINT SETUP”.
3. Press the **SELECT** soft key, then select “WAYPOINT DIRECTORY” with the **CHANNEL** knob.
4. Press the **SELECT** soft key, then select “EDIT” with the **CHANNEL** knob.
5. Rotate the **CHANNEL** knob to select the waypoint to be edited.
6. Press the **ENT** soft key to show the waypoint Input display.
7. Press the **ENT** soft key repeatedly until the number or letter is selected that is to be changed.
8. Rotate the **CHANNEL** knob to change the letter or number.
9. Repeat step 7 and 8 until the waypoint is updated.
10. Press and hold the **ENT** soft key to store the edited waypoint into memory.
11. Press the **QUIT** soft key several times to return to radio operation.

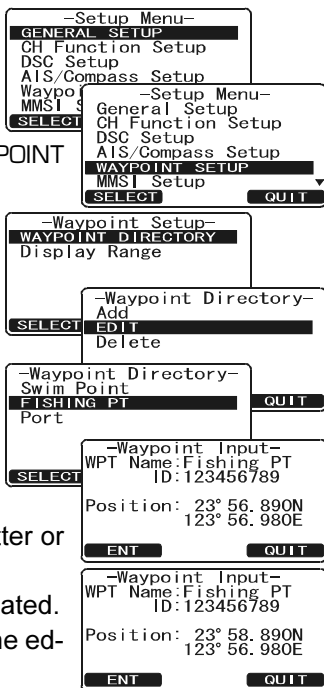

14.4 DELETING A WAYPOINT

1. Press and hold down the  key until “Setup Menu” appears.
2. Rotate the **CHANNEL** knob to select “WAYPOINT SETUP”.
3. Press the **SELECT** soft key, then select “WAYPOINT DIRECTORY” with the **CHANNEL** knob.
4. Press the **SELECT** soft key, then select “DELETE” with the **CHANNEL** knob.
5. Rotate the **CHANNEL** knob to highlight the waypoint to be deleted.
6. Press and hold the **SELECT** soft key until the radio beeps and the waypoint directory is removed from the display.
7. Press the **QUIT** soft key several times to return to radio operation.

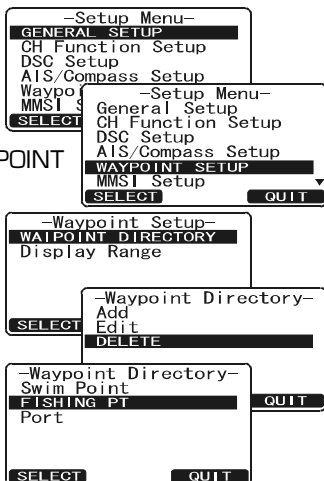

14.5 SAVING A DSC POSITION CALL AS A WAYPOINT

When a position is received from a another DSC radio the **GX2000/GX2150** allows the position to be saved as a waypoint.

1. After a position has been received, press the **SAVE** soft key two times.
2. The first digit in the WPT Name will be flashing, rotate the **CHANNEL** knob to the first letter of the name you want to input.
3. Press the **ENT** soft key, then rotate the **CHANNEL** knob to select the second letter in the name.
4. Repeat step 3 until the name is shown.
5. Press and hold the **ENT** soft key until the radio beeps to save the waypoint to memory.
6. Press the **QUIT** soft key several times to return to radio operation.

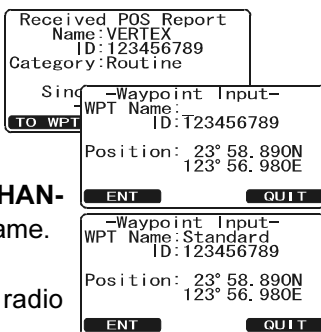

14.6 NAVIGATING TO A SAVED WAYPOINT

1. Press and hold down the **CALL MENU** key until "Setup Menu" appears.
2. Rotate the **CHANNEL** knob to select "GENERAL SETUP".
3. Press the **SELECT** soft key, then select "DISPLAY" with the **CHANNEL** knob.
4. Press the **ENT** soft key, and select "WAYPOINT", and press the **SELECT** soft key.
5. Select the waypoint name and press the **ENT** soft key to show the waypoint data display.
6. Press the **ENT** soft key to start navigating the waypoint and show the Waypoint Nav display.

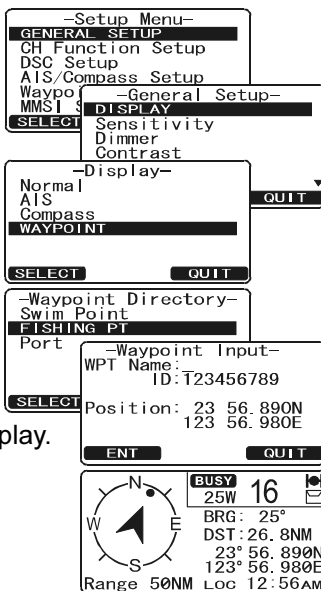

NOTE

The radio must be connected to a GPS to be able to navigate to a waypoint.

14.7 STOP NAVIGATING TO A WAYPOINT

1. Press the one of the Soft key to show the key selections.
2. Press the **STOP** key. The radio will stop navigating to a the waypoint and the Normal VHF display will be shown.

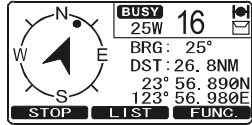



15 RAM3 (CMP30) REMOTE MIC OPERATION



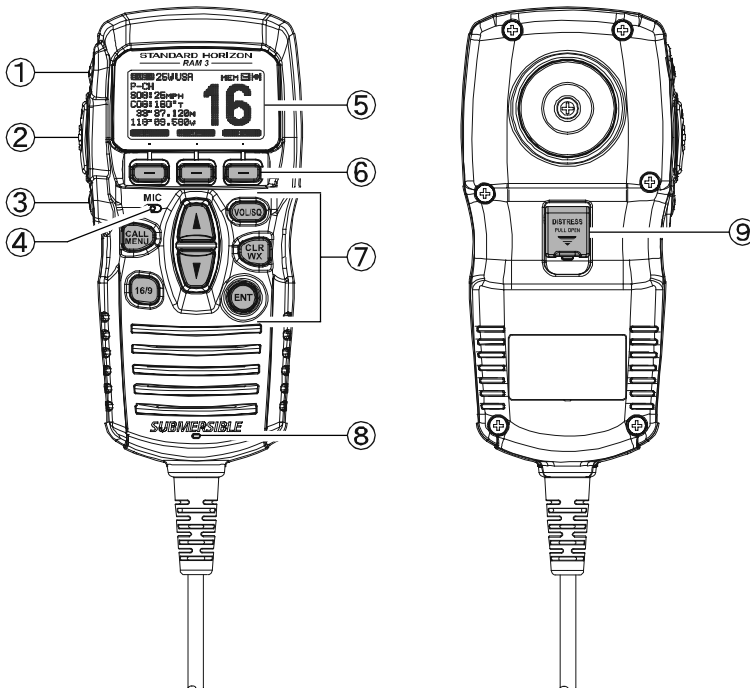





When the Remote MIC is connected to the **GX2000/GX2150**, all VHF, DSC, setup menus, AIS, Waypoint, Compass functions and PA/Fog modes can be remotely operated. The **RAM3 (CMP30)** Remote Station Microphone operation is same as **GX2000/GX2150** except the receiver audio volume setting and squelch level setting. The reason for the same operation is to make the operation of the radio and **RAM3 (CMP30)** easy. For specific operation of the **RAM3 (CMP30)** review sections in the radio manual. The **RAM3 (CMP30)** is supplied with 23 feet (7 m) of routing cable and can be extended up to 70 feet (21 m) using three 23-foot extension cables model **CT-100**. The Intercom feature can be used between the **RAM3 (CMP30)** and the **GX2000/GX2150**. In addition, speaker wires are supplied at the panel mount of the routing cable for external speakers to be connected in noisy environments.

15.1 REMOTE MIC CONTROLS



① KEY



Toggles between high and low power. When the  key is pressed while the transceiver is on CH13 or CH67, the power is temporarily switched from LO to HI until the **PTT** switch is released. The  key does not function on transmit inhibited and low-power only channels.

- ② **PTT (Push-To-Talk) Key**
Push this key to enable the transmitter.
- ③  **(POWER) Key**
Press and hold down this key to turn the transceiver and Remote MIC on or off.
- ④ **MICROPHONE**
The internal ClearVoice Noise Canceling mic is located here.
When transmitting, position your mouth about 1/2 to 1 inch (1.2 ~ 2.5 cm) away from the small mic hole. Speak slowly and clearly into the microphone.
- ⑤ **DISPLAY**
132 x 64 pixels Full dot matrix display.
- ⑥ **SOFT KEY**
These three key's functions can be customized by the Setup Menu mode. When press one of these key briefly, the key functions will appear at the bottom of the display. Refer to section "17.2 ASSIGNING SOFT KEYS" for details.
- ⑦ **KEY PAD**
-  Key
Press this key to access the DSC menu.
Press and hold this key to access the SETUP menu.
-  Key
First press: channel 16 is immediately selected.
Second press: recalls the last selected channel.
Press and hold: selects channel 9.
-  /  Key
These keys are used to select channels, adjust the volume and squelch level, and to choose DSC calls, DSC setup and Radio setup function.
-  Key (Volume Control / Squelch Control)
First press: Volume adjustment mode
Second press: Squelch adjustment mode
Third press: exits adjustment mode
When in volume or squelch mode, press the  or  keys to adjust the level.

Key

Press to CLEAR a function or menu selection. Press and hold to select NOAA Weather channels. Press and hold again to exit Weather mode and revert to radio mode.

Secondary use

Hold down the  key while pressing the  key to change the mode from USA to International or Canadian.

Key

This key functions as the enter key.

8 SPEAKER



















The internal speaker is located here.

9 [DISTRESS] KEY

Used to send a DSC Distress call. Refer to section “9 DIGITAL SELECTIVE CALLING”.

15.2 ASSIGNING SOFT KEYS

This menu item allows selection of the number of soft keys, soft key selection and how long the display will show the soft key icon after a soft key is pressed. The keys maybe setup to control the following functions:

1. Press and hold down the  key until “Setup Menu” appears, then select “GENERAL SETUP” with the  or  key.
2. Press the  soft key, then press the  key to select “SOFT KEY”.
3. Press the  soft key, then press the  key to select “NUMBER OF SOFT KEYS”.
4. Press the  soft key, then press the  or  key to select the number of soft keys (3 through 10).
5. Press the  soft key, then press the  key to select “KEY ASSIGNMENT” (to change the use of selected soft keys). Then press the  soft key.
6. Press the  or  key to select the key (“KEY1”, “KEY2”, “KEY3” etc), and press the  soft key. Then press the  or  key to select the new function to be assigned, and press the  soft key. Available functions are listed next page. Repeat step 6 to pro-

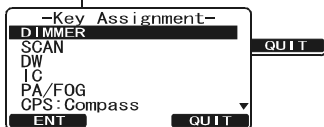
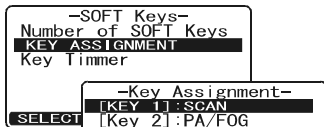
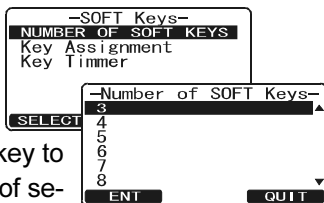
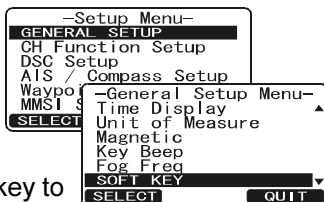

gram the other soft keys.

7. Press the **QUIT** soft key, then press the **▲** or **▼** key to select "KEY TIMER" (selects how long the soft key icon will be shown on the display after a soft key is pressed, default is 5 seconds). Then, press the **SELECT** soft key.
8. Press the **▲** or **▼** key to select the time.
9. Press the **ENT** soft key to store the selected setting.
10. Press the **QUIT** soft key several times to return to radio operation.

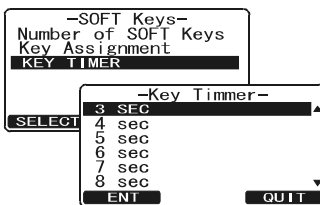

DISPLAY	FUNCTION
DIMMER	Select the menu for the display and key back light intensity
SCAN	Starts and stops Scanning.
DW	Starts and stops Dual Watch Scan.
IC	Activates Intercom between radio and RAM3 mic.
PA/FOG	Activates the PA / Fog Horn function.
CPS: COMPASS	Shows to the "Compass" display.
WPT	Shows to the "Waypoint" Navigation display.
AIS	Shows to the "AIS" display.
AIS AL	Toggles the AIS alarm "on" and "off".
PRESET	Programs or deletes the preset memory channel. Refer to section 8.9 for operation
MARK	Mark the current position for a "Waypoint".
PSET 0 - PSET 9	Immediately recalls the preset memory channel. Refer to section 8.9 for operation

16 MAINTENANCE

The inherent quality of the solid-state components used in this transceiver will provide many years of continuous use. Taking the following precautions will prevent damage to the transceiver.

- Keep the microphone connected or the jack covered at all times to prevent corrosion of electrical contacts;
- Never key the microphone unless an antenna or suitable dummy load is connected to the transceiver.
- Ensure that the supply voltage to the transceiver does not exceed 16 VDC or fall below 11 VDC.
- Use only STANDARD HORIZON-approved accessories and replacement parts.

In the unlikely event of serious problems, please contact your Dealer or our repair facility. Address and phone numbers for this facility, as well as warranty information, are contained in section “**18 WARRANTY.**”

16.1 REPLACEMENT PARTS

Occasionally an owner needs a replacement mounting bracket or knob. These can be ordered from our Parts Department by writing or calling:

Marine Division of Vertex Standard

US Headquarters

10900 Walker Street, Cypress, CA 90630, U.S.A.

Telephone (714) 827-7600

Commonly requested parts, and their part numbers are listed below.

- **Power Cord:** T9025406
- **VOL and SQL Knob:** RA1168000 (White), RA1168100 (Black)
- **CH Knob:** RA1167800 (White), RA1167900 (Black)
- **Mounting Bracket:** RA078410A (White), RA078400A (Black)
- **Mounting Bracket Knob:** RA0978500 (White), RA0978600 (Black)
- **Microphone Hanger:** RA0436000 (White), RA0458800 (Black)
- **RAM3 Mic Routing Cable Assembly:** S8101512
- **Dust Cover:** RA1288100 (White only)

16.2 FACTORY SERVICE

In the unlikely event that the radio fails to perform or needs servicing, please contact the following:

Standard Horizon

Attention Marine Repair Department

10900 Walker Street, Cypress, CA 90630

Telephone (800) 366-4566

An "RA" Return Authorization number is not necessary to send a product in for service. Include a brief note describing the problem along with your name, return address, phone number, and proof of purchase.

16.3 TROUBLESHOOTING CHART

SYMPTOM	PROBABLE CAUSE	REMEDY
Transceiver fails to power up.	No DC voltage to the transceiver, or blown fuse.	a. Check the 12VDC battery connections and the fuse. b. The VOL/PWR knob needs to be pressed and held to turn the radio on.
Transceiver blows fuse when connected to power supply.	Reversed power wires.	Check the power cable for DC voltage, or replace the fuse (6A 250V). Make sure the red wire is connected to the positive (+) battery post, and the black wire is connected to the negative (-) battery post. If the fuse still blows, contact your Dealer.
Popping or whining noise from the speaker while engine runs.	Engine noise.	Reroute the DC power cables away from the engine. Add noise suppressor on power cable. Change to resistive spark plug wires and/or add an alternator whine filter.
Sound is not emitted from the internal or external speaker.	Accessory cable.	Check the connections of the accessory cable (Short Circuit the External speaker cable WHITE/SHIELD).
Sound is not emitted from the PA speaker.	Accessory cable.	Check the accessory cable connection (Short Circuit the PA speaker cable RED/SHIELD).
Receiving station reports low signal strength, even with transceiver set to HI power.	Antenna.	Have the antenna checked or test the transceiver with another antenna. If the problem persists, contact your Dealer for servicing.
"HI BATTERY" or "LO BATTERY" message appears when the power is turned on.	The power supply voltage is too high or too low.	Confirm that the connected power supply voltage is not 17 volts or lower than 10 volts.
"AIS" information is not displayed (GX2000).	Accessory cable.	Check the accessory cable connection (Short Circuit the NMEA-HS(+) cable BROWN and NMEA-COMMON (-) cable GREEN). Check the baud rate setting of the AIS receiver is 38400 baud.
Your position is not displayed.	Accessory cable.	Check the accessory cable connection. Some GPS use the battery ground line for NMEA connection.
	Setting of the GPS navigation receiver.	Check the output signal format of the GPS navigation receiver. This radio requires NMEA0183 format with GLL, RMB, or RMC sentence as an output signal. If the GPS has a baud rate setting make sure to select 4800 and parity to NONE.

17 CHANNEL ASSIGNMENTS

Tables on the following columns list the VHF Marine Channel assignments for U.S.A. and International use. Below are listed some data about the charts.

1. VTS. Where indicated, these channels are part of the U.S. Coast Guard's Vessel Traffic System.
2. Alpha channel numbers, that is, channel numbers followed by the letter A (such as Channel 07A) are **simplex** channels on the U.S.A. or Canadian channel assignments whose counterparts in the International assignments are **duplex** channels. International channels do not use "alpha" numbers. If you call the Coast Guard on Channel 16, they will sometimes ask you to "**go to channel 22 Alpha**." This is a channel assigned to U.S.A., and Canadian Coast Guards for handling distress and other calls. If your radio is set for **International** operation you will go to Channel 22 instead of 22A, and will not be able to communicate with the Coast Guard. To use Channel 22A, your radio must be set for **USA** or **Canada** operation, usually by a U/I/C (USA/International/Canada) control or combination of controls. Channel 22 (without an "A") is an **International** duplex channel for port operations. Some radios indicate an "A" adjacent to the alpha channels on the display; on others "alpha" is not indicated but the proper channel is selected based on the U/I/C setting.
3. Bridge-to-Bridge channels (for example, Channel 13) are for use by bridge operators on inter-coastal waterways and rivers. It is also used by marine vessels in the vicinity of these bridges for navigation and for communicating with the bridge operators. Note that a limit of 1 Watt is specified for these channels.
4. The **S/D** column on the chart indicates either S (simplex) or D (duplex). **Simplex** means transmitting and receiving on the same frequency. Only one party at a time can talk, unlike a telephone. Be sure to say "**over**" and release your microphone push-to-talk switch at the end of each transmission. **Duplex** operation involves the use of one frequency for transmitting and a separate frequency for receiving. On channels specified as duplex on the charts, correct mode of operation is established automatically by your radio when you select a channel; you cannot change the mode. And you still must release the push-to-talk switch after each transmission in order to listen to the radio.
5. Channels normally used by recreational boaters are those that include the term "non-commercial" in the **Channel Use** column of the chart. Some of these are shared with other users and some are used only in certain geographic regions.

6. Marine vessels equipped with VHF radios are required to monitor Channel 16.
7. 156.050 MHz and 156.175 MHz are available for port operations and commercial communications purposes when used only within the U.S. Coast Guard designated Vessel Traffic Services (VTS) area of New Orleans, on the lower Mississippi River from the various pass entrances in the Gulf of Mexico to Devil's Swamp Light at River Mile 242.4 above head of passes near Baton Rouge.
8. 156.250 MHz is available for port operations communications use only within the U.S. Coast Guard designated VTS radio protection areas of New Orleans and Houston described in Sec. 80.383. 156.250 MHz is available for intership port operations communications used only within the area of Los Angeles and Long Beach harbors, within a 25- nautical mile radius of Point Fermin, California.
9. 156.550 MHz, 156.600 MHz and 156.700 MHz are available in the U.S. Coast Guard designated port areas only for VTS communications and in the Great Lakes available primarily for communications relating to the movement of ships in sectors designated by the St. Lawrence Seaway Development Corporation or the U.S. Coast Guard. The use of these frequencies outside VTS and ship movement sector protected areas is permitted provided they cause no interference to VTS and ship movement communications in their respective designated sectors.
10. Use of 156.875 MHz is limited to communications with pilots regarding the movement and docking of ships. Normal output power must not exceed 1 watt. 5: 156.375 MHz and 156.650 MHz are available primarily for intership navigational communications. These frequencies are available between coast and ship on a secondary basis when used on or in the vicinity of locks or drawbridges. Normal output power must not exceed 1 watt. Maximum output power must not exceed 10 watts for coast stations or 25 watts for ship stations.
11. On the Great Lakes, in addition to bridge-to-bridge communications, 156.650 MHz is available for vessel control purposes in established vessel traffic systems. 156.650 MHz is not available for use in the Mississippi River from South Pass Lighted Whistle Buoy "2" and Southwest Pass entrance Mid-channel Lighted Whistle Buoy to mile 242.4 above Head of Passes near Baton Rouge. Additionally it is not available for use in the Mississippi River-Gulf Outlet, the Mississippi River-Gulf Outlet Canal, and the Inner Harbor Navigational Canal, except to aid the transition from these areas.

12. Use of 156.375 MHz is available for navigational communications only in the Mississippi River from South Pass Lighted Whistle Buoy "2" and Southwest Pass entrance Mid channel Lighted Whistle Buoy to mile 242.4 above head of Passes near Baton Rouge, and in addition over the full length of the Mississippi River-Gulf Outlet Canal from entrance to its junction with the Inner Harbor Navigation Canal, and over the full length of the Inner Harbor Navigation Canal from its junction with the Mississippi River to its entry to Lake Pontchartrain at the New Seabrook vehicular bridge.
13. Within 120 km (75 miles) of the United States/Canada border, in the area of the Puget Sound and the Strait of Juan de Fuca and its approaches, 157.425 MHz is half of the duplex pair designated as Channel 88. In this area, Channel 88 is available to ship stations for communications with public coast stations only. More than 120 km (75 miles) from the United States/Canada border in the area of the Puget Sound and the Strait of Juan de Fuca, its approaches, the Great Lakes, and the St. Lawrence Seaway, 157.425 MHz is available for intership and commercial communications. Outside Puget Sound area and its approaches and the Great Lakes, 157.425 MHz is also available for communications between commercial fishing vessels and associated aircraft while engaged in commercial fishing activities.
14. When the frequency 156.850 MHz is authorized, it may be used additionally for search and rescue training exercises conducted by state or local governments.
15. The frequency 156.850 MHz is additionally available to coast stations on the Great Lakes for transmission of scheduled Coded Marine Weather Forecasts (MAFOR), Great Lakes Weather Broadcast (LAWEB) and scheduled Notices to Mariners or Bulletins. F3C and J3C emissions are permitted. Coast Stations on the Great Lakes must cease weather broadcasts which cause interference to stations operating on 156.800 MHz until the interference problem is resolved.
16. The frequency 157.100 MHz is authorized for search and rescue training exercises by state or local government in conjunction with U.S. Coast Guard stations. Prior U.S. Coast Guard approval is required. Use must cease immediately on U.S. Coast Guard request.
17. The duplex pair for channel 20 (157.000/161.600 MHz) may be used for ship to coast station communications.
18. Available for assignment to coast stations, the use of which is in accord with an agreed program, for the broadcast of information to ship stations concerning the environment.

VHF MARINE CHANNEL CHART							
CH	U	C	I	S/D	TX	RX	CHANNEL USE
01		X	X	D	156.050	160.650	Public Correspondence (Marine Operator)
01A	X			S	156.050		Port Operation and Commercial. VTS in selected areas
02		X	X	D	156.100	160.700	Public Correspondence (Marine Operator)
03		X	X	D	156.150	160.750	Public Correspondence (Marine Operator)
03A	X			S	156.150		U.S. Government Only, Coast Guard
04			X	D	156.200	160.800	Public Correspondence (Marine Operator), Port operation, ship movement
04A		X		S	156.200		Pacific coast: Coast Guard, East Coast: Commercial fishing
05			X	D	156.250	160.850	Public Correspondence (Marine Operator), Port operation, ship movement
05A	X	X		S	156.250		Port operation. VTS in Seattle
06	X	X	X	S	156.300		Inter-ship Safety
07			X	D	156.350	160.950	Public Correspondence (Marine Operator), Port operation, ship movement
07A	X	X		S	156.350		Commercial
08	X	X	X	S	156.400		Commercial (Inter-ship only)
09	X	X	X	S	156.450		Boater Calling channel, Commercial & Non-commercial (Recreational)
10	X	X	X	S	156.500		Commercial
11	X	X	X	S	156.550		Commercial. VTS in selected areas.
12	X	X	X	S	156.600		Port operation. VTS in selected areas.
13	X	X	X	S	156.650		Inter-ship Navigation Safety (Bridge-to-bridge)
14	X	X	X	S	156.700		Port operation. VTS in selected areas.
15	X			S	---	156.750	Environmental (Receive only)
15		X	X	S	156.750		Commercial, non-commercial, ship movement (1 W)
16	X	X	X	S	156.800		International Distress, Safety and Calling
17	X	X	X	S	156.850		State Controlled (1 W)
18			X	D	156.900	161.500	Port operation, ship movement
18A	X	X		S	156.900		Commercial
19			X	D	156.950	161.550	Port operation, ship movement
19A	X			S	156.950		US: Commercial
19A		X		S	156.950		Coast Guard
20	X	X	X	D	157.000	161.600	Canadian Coast Guard Only, International: port operations and shipment
20A	X			S	157.000		Port operation
21			X	D	157.050	161.650	Port operation, ship movement
21A	X	X		S	157.050		U.S. Government Only, Canadian Coast Guard
22			X	D	157.100	161.700	Port operation, ship movement
22A	X	X		S	157.100		US and Canadian Coast Guard Liaison and Maritime Safety Information Broadcasts announced on channel 16
23		X	X	D	157.150	161.750	Public Correspondence (Marine Operator)
23A	X			S	157.150		U.S. Government Only
24	X	X	X	D	157.200	161.800	Public Correspondence (Marine Operator)
25	X	X	X	D	157.250	161.850	Public Correspondence (Marine Operator)
26	X	X	X	D	157.300	161.900	Public Correspondence (Marine Operator)
27	X	X	X	D	157.350	161.950	Public Correspondence (Marine Operator)
28	X	X	X	D	157.400	162.000	Public Correspondence (Marine Operator)

VHF MARINE CHANNEL CHART							
CH	U	C	I	S/D	TX	RX	CHANNEL USE
60		X	X	D	156.025	160.625	Public Correspondence (Marine Operator)
61			X	D	156.075	160.675	Public Correspondence (Marine Operator), Port operation, ship movement
61A	X	X		S	156.075		Public Coast: Coast Guard; East Coast: commercial fishing only
62			X	D	156.125	160.725	Public Correspondence (Marine Operator), Port operation, ship movement
62A		X		S	156.125		Public Coast: Coast Guard; East Coast: commercial fishing only
63			X	D	156.175	160.775	Public Correspondence (Marine Operator), Port operation, ship movement
63A	X	X		S	156.175		Port Operation and Commercial. VTS in selected areas.
64		X	X	D	156.225	160.825	Public Correspondence (Marine Operator), Port operation, ship movement
64A	X	X		S	156.225		Public Correspondence (Marine Operator), Port operation, ship movement
65			X	D	156.275	160.875	Public Correspondence (Marine Operator), Port operation, ship movement
65A	X	X		S	156.275		Port Operations
66			X	D	156.325	160.925	Public Correspondence (Marine Operator), Port operation, ship movement
66A	X	X		S	156.325		Port Operations
67	X	X	X	S	156.375		US: Commercial. Used for Bridge-to-bridge com- munications in lower Mississippi River. Inter-ship only, Canada: Commercial fishing, S&R
68	X	X	X	S	156.425		Non-commercial (Recreational)
69	X	X	X	S	156.475		US: Non-commercial (Recreational), Canada: Commercial fishing only, International: Inter-ship, Port operations and Ship movement
70	X	X	X	S	156.525		Digital selective calling (voice communications not allowed)
71	X	X	X	S	156.575		US, Canada: Non-commercial (Recreational), International: Port operations and Ship movement
72	X	X	X	S	156.625		Non-commercial (Inter-ship only)
73	X	X	X	S	156.675		US: Port Operations, Canada: Commercial fish ing only, International: Inter-ship, Port operations and Ship movement
74	X	X	X	S	156.725		US: Port Operations, Canada: Commercial fishing only, International: Inter-ship, Port operations and Ship movement
75	X	X	X	S	156.775		Port Operations (Inter-ship only) (1W)
76	X	X	X	S	156.825		Port Operations (Inter-ship only) (1W)
77	X	X		S	156.875		Port Operations (Inter-ship only) (1W)
77			X	S	156.875		Port Operations (Inter-ship only)
78			X	D	156.925	161.525	Public Correspondence (Marine Operator), Port operation, ship-movement
78A	X	X		S	156.925		Non-commercial (Recreational)
79			X	D	156.975	161.575	Port operation and Ship movement
79A	X	X		S	156.975		Commercial

VHF MARINE CHANNEL CHART							
CH	U	C	I	S/D	TX	RX	CHANNEL USE
80			X	D	157.025	161.625	Port operation, ship movement
80A	X	X		S	157.025		Commercial
81			X	D	157.075	161.675	Port operation, ship movement
81A	X			S	157.075		U.S. Government Only - Environmental protection operations.
81A		X		S	157.075		Canadian Coast Guard Only
82			X	D	157.125	161.725	Public Correspondence (Marine Operator), Port operation, ship movement
82A	X	X		S	157.125		U.S. Government Only, Canadian Coast Guard Only
83		X		D	157.175	161.775	Canadian Coast Guard Only
83			X	D	157.175	161.775	Public Correspondence (Marine Operator)
83A	X	X		S	157.175		U.S. Government Only, Canadian Coast Guard Only
84	X	X	X	D	157.225	161.825	Public Correspondence (Marine Operator)
85	X	X	X	D	157.275	161.875	Public Correspondence (Marine Operator)
86	X	X	X	D	157.325	161.925	Public Correspondence (Marine Operator)
87		X	X	S	157.375		Port operation, ship movement
87A	X			S	157.375		Public Correspondence (Marine Operator)
88		X	X	S	157.425		Port operation, ship movement
88A	X			S	157.425		Commercial, Inter-ship Only
WX01	X	X	X	S	---	162.550	Weather (receive only)
WX02	X	X	X	S	---	162.400	Weather (receive only)
WX03	X	X	X	S	---	162.475	Weather (receive only)
WX04	X	X	X	S	---	162.425	Weather (receive only)
WX05	X	X	X	S	---	162.450	Weather (receive only)
WX06	X	X	X	S	---	162.500	Weather (receive only)
WX07	X	X	X	S	---	162.525	Weather (receive only)
WX08	X	X	X	S	---	161.650	Weather (receive only)
WX09	X	X	X	S	---	161.775	Weather (receive only)
WX10	X	X	X	S	---	163.275	Weather (receive only)

NOTE: Simplex channels, 3A, 21A, 23A, 61A, 64A, 81A, 82A and 83A CANNOT be lawfully used by the general public in U.S.A. waters.

18 WARRANTY

Marine Products Limited Warranty

PLEASE NOTE

The following “Limited Warranty” is for valid for products that have been purchased in the United States and Canada. For limited Warranty details outside the United States, contact the dealer in your country.

STANDARD HORIZON (a division of VERTEX STANDARD) warrants, to the original purchaser only, each new Marine Communications Product (“Product”) manufactured and/or supplied by STANDARD HORIZON against defects in materials and workmanship under normal use and service for a period of time from the date of purchase as follows:

Fixed Mount and Portable Transceivers

1 year - if purchased before 01/01/91

3 years - if purchased between 01/01/91 and 01/01/94

3 years Waterproof - if purchased after 01/01/94

Loud hailers

1 year - if purchased before 01/01/91

3 years - if purchased after 01/01/91

Associated Chargers

1 year - if purchased before 01/01/91

3 years - if purchased after 01/01/91

Associated Batteries - 18 months. Note: Batteries will be deemed defective only if storage capacity drops below 80% of rated capacity or if leakage develops.

Associated Accessories - 1 year. Includes: Microphones/Handsets, External Speakers, Antennas, Carrying Accessories, Power Supplies, and Signaling Boards.

To receive warranty service, the purchaser must deliver the Product, transportation and insurance prepaid, to STANDARD HORIZON (a division of VERTEX STANDARD), Attention Marine repairs 10900 Walker Street, Cypress, CA 90630. Include proof of purchase indicating model, serial number, and date of purchase. STANDARD HORIZON will return the Product to the purchaser freight prepaid. Products purchased prior to January 1, 1991 will bear the STANDARD HORIZON warranty terms in effect prior to that date.

In the event of a defect, malfunction or failure of the Product during the warranty period, STANDARD HORIZON's liability for any breach of contract or any breach of express or implied warranties in connection with the sale of Products shall be limited solely to repair or replacement, at its option, of the Product or part(s) therein which, upon examination by STANDARD HORIZON,

appear to be defective or not up to factory specifications. STANDARD HORIZON may, at its option, repair or replace parts or subassemblies with new or reconditioned parts and subassemblies. Parts thus repaired or replaced are warranted for the balance of the original applicable warranty.

STANDARD HORIZON will not warrant installation, maintenance or service of the Products. In all instances, STANDARD HORIZON's liability for damages shall not exceed the purchase price of the defective Product.

This warranty only extends to Products sold within the 50 States of the United States of America and the District of Columbia.

STANDARD HORIZON will pay all labor to repair the product and replacement parts charges incurred in providing the warranty service except where purchaser abuse or other qualifying exceptions exist. The purchaser must pay any transportation expenses incurred in returning the Product to STANDARD HORIZON for service.

This limited warranty does not extend to any Product which has been subjected to misuse, neglect, accident, incorrect wiring by anyone other than STANDARD HORIZON, improper installation, or subjected to use in violation of instructions furnished by STANDARD HORIZON, nor does this warranty extend to Products on which the serial number has been removed, defaced, or changed. STANDARD HORIZON cannot be responsible in any way for ancillary equipment not furnished by STANDARD HORIZON which is attached to or used in connection with STANDARD HORIZON's Products, or for the operation of the Product with any ancillary equipment, and all such equipment is expressly excluded from this warranty. STANDARD HORIZON disclaims liability for range, coverage, or operation of the Product and ancillary equipment as a whole under this warranty. STANDARD HORIZON reserves the right to make changes or improvements in Products, during subsequent production, without incurring the obligation to install such changes or improvements on previously manufactured Products.

The implied warranties which the law imposes on the sale of this Product are expressly LIMITED, in duration, to the time period specified above. STANDARD HORIZON shall not be liable under any circumstances for consequential damages resulting from the use and operation of this Product, or from the breach of this LIMITED WARRANTY, any implied warranties, or any contract with STANDARD HORIZON. IN CONNECTION WITH THE SALE OF ITS PRODUCTS, STANDARD HORIZON MAKES NO WARRANTIES, EXPRESS OR IMPLIED AS TO THE MERCHANTABILITY OR FITNESS FOR A PARTICULAR PURPOSE OR OTHERWISE, EXCEPT AS EXPRESSLY SET FORTH HEREIN.

Some states do not allow the exclusion or limitation of incidental or consequential damages, or limitation on how long an implied warranty lasts, so the above limitations or exclusions may not apply. This warranty gives specific legal rights, and there may be other rights which may vary from state to state.

ONLY PRODUCTS SOLD ON OR AFTER JANUARY 1, 1991 ARE COVERED UNDER THE TERMS OF THIS LIMITED WARRANTY.

ON-LINE WARRANTY REGISTRATION

THANK YOU for buying STANDARD HORIZON (a division of Vertex Standard) products! We are confident your new radio will serve your needs for many years!

Please visit **www.standardhorizon.com** to register your Marine VHF. It should be noted that visiting the Web site from time to time may be beneficial to you, as new products are released they will appear on the STANDARD HORIZON Web site. Also a statement regarding product support should be added to the manual.

Product Support Inquiries

If you have any questions or comments regarding the use of the radio, you can visit the STANDARD HORIZON Web site to send an E-Mail or contact the Product Support team at (714) 827-7600 ext 6300 M-F 7:00-5:00PST.

In addition to the warranty, STANDARD HORIZON includes a lifetime "flat rate" and "customer loyalty" programs to provide service after the warranty period has expired. If you wish to obtain the flat rate price for out-of-warranty repair, you must include the information on the Owner's Record with the unit when you return it to your Dealer or to STANDARD HORIZON.

Lifetime Flat Rate Service Program: For the original Owner only, for the lifetime of the unit, STANDARD HORIZON will repair the unit to original specifications.

Note: The flat rate amount is payable by the Owner only if STANDARD HORIZON or the STANDARD HORIZON Dealer determines that a repair is needed. After the repair, a 90-day warranty will be in effect from the date of return of the unit to the Owner.

This service program is not available for equipment which has failed as a result of neglect, accident, breakage, misuse, improper installation or modification, or water damage (depending on the product).



19 RESET PROCEDURES

19.1 MEMORY CLEAR

To clear the Scan memory and Preset memory:

1. Turn the radio off.
2. Press and hold in the three Soft keys while turning the radio on.

19.2 MICROPROCESSOR RESETTING

To clear all memories and other settings to factory defaults (except the Channel Group, MMSI number, and DSC directory information):

1. Turn the radio off.
2. Press and hold in the , , and  keys while turning the radio on.

20 SPECIFICATIONS

Performance specifications are nominal, unless otherwise indicated, and are subject to change without notice.

20.1 GENERAL

Channels	All USA, International and Canadian
Normal Input Voltage	13.8 V DC
Operating Voltage Range	11 V to 16.5 V
Current Drain	
Standby	0.55 A (GX2150), 0.45 A (GX2000)
Receiver (at Maximum AF Output)	0.9 A (GX2150), 0.8 A (GX2000)
Transmit	5.0 A (Hi), 1.0 A (Lo)
Distress Call Log	26
Individual Call Log	64
Individual Call Directory	80
Group Call Directory	32
Waypoint Directory	100
Display Type	2.75" x 1.33" (70 x 34 mm) Full Dot Matrix (132 x 64 pixels)
Dimensions (WxHxD)	7.1" x 3.1" x 6.3" (180 x 80 x 160 mm)
Flush-Mount Dimensions (WxHxD)	6.3" x 2.6" x 5.9" (161 x 65 x 150 mm)
Weight (GX2000)	3.1 lbs (1.40 kg)
Weight (GX2150)	3.2 lbs (1.45 kg)

20.2 TRANSMITTER

Frequency Range	156.025 MHz to 157.425 MHz
RF Output Power	25 W (Hi), 1 W (Lo)
Conducted Spurious Emissions	Less than -80 dBc (Hi), -66 dBc (Lo)
Audio Response	within +1/-3dB of a 6 dB/Octave pre-emphasis characteristic at 300 to 3000 Hz
Audio Distortion	Less than 5 %
Modulation	16K0G3E (for Voice), 16K0G2B (for DSC)
Frequency Stability	±0.0003 % (-20 °C to +60 °C)
FM Hum and Noise	50 dB

20.3 RECEIVER (for Voice and DSC)

Frequency Range	156.050 MHz to 163.275 MHz
Sensitivity	
20 dB Quieting	0.35 μ V
12 dB SINAD	0.30 μ V
Squelch Sensitivity (Threshold)	0.13 μ V
Modulation Acceptance Bandwidth	\pm 7.5 kHz
Selectivity (Typical)	
Spurious and Image Rejection	80 dB for Voice (75 dB for DSC)
Intermodulation and Rejection	80 dB for Voice (75 dB for DSC)
Audio Output	4.5 W (at 4 ohms external speaker output)
Audio Response	within +1/-3dB of a 6 dB/Octave de-emphasis characteristic at 300 to 3000 Hz
Frequency Stability	\pm 0.0003 % (-20 °C to +60 °C)
Channel Spacing	25 kHz
DSC Format	ITU-R M.493-13
Antenuator (Local)	Approx. 10 dB

20.4 RECEIVER (for AIS)

Frequency	161.975 MHz (CH A), 162.025 MHz (CH B)
Sensitivity	0.5 μ V (at 12 dB SINAD)
Selectivity(Typical)	
Spurious and Image Rejection	70 dB
Intermodulation and Rejection	70 dB

20.5 NMEA INPUT/OUTPUT

GX2000

NMEA 0183 GPS Input (4800 baud)	GGA, GLL, GNS, & RMC
NMEA 0183 VHF DSC Output (4800 baud)	DSC & DSE
NMEA 0183 AIS Input (38400 baud)	VDM

GX2150

4800 Baud selected:

NMEA 0183 GPS Input (4800 baud)	GGA, GLL, GNS, RMC, GSA, & GSV
NMEA 0183 VHF DSC Output (4800 baud)	DSC & DSE
NMEA 0183 AIS Output (38400 baud)	VDM

38400 Baud selected:

NMEA 0183 GPS Input (38400 baud) ...	GGA, GLL, GNS, RMC, GSA, & GSV
NMEA 0183 VHF DSC Output (38400 baud)	DSC, DSE & VDM
NMEA 0183 AIS Output (38400 baud)	VDM

20.6 DIMENSIONS

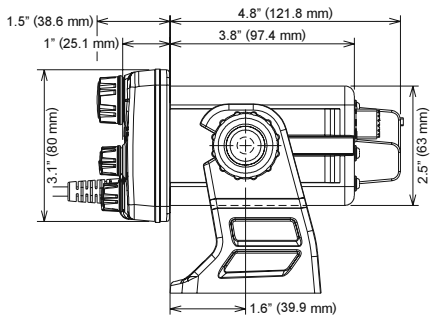
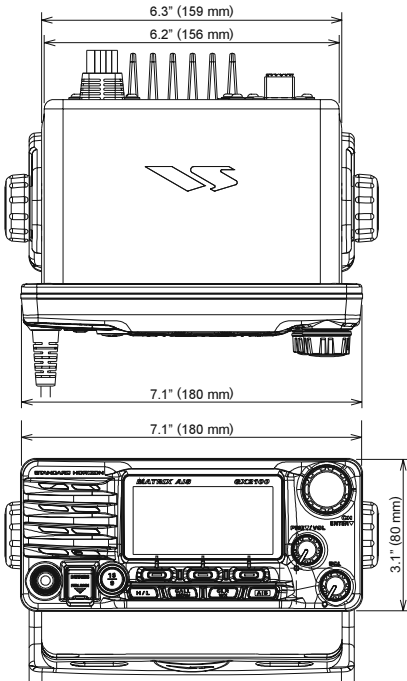
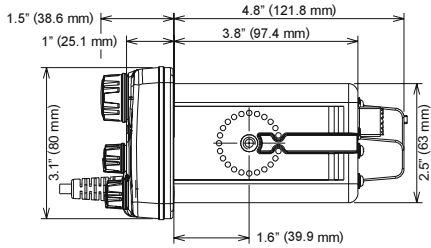
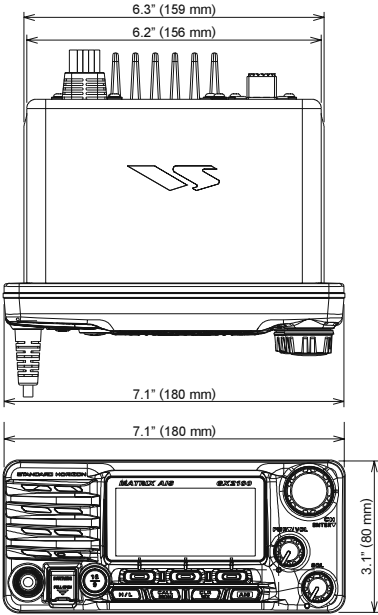

21 FCC RADIO LICENSE INFORMATION

Standard Horizon radios comply with the Federal Communication Commission (FCC) requirements that regulate the Maritime Radio Service.

21.1 STATION LICENSE

An FCC ship station license is no longer required for any vessel traveling in U.S. waters (except Hawaii) which is under 20 meters in length. However, any vessel required to carry a marine radio on an international voyage, carrying a HF single side band radiotelephone or marine satellite terminal is required to have a ship station license. FCC license forms, including applications for ship (605) and land station licenses can be downloaded via the Internet at <http://www.fcc.gov/Forms/Form605/605.html>. To obtain a form from the FCC, call (888) 225-5322.

21.2 RADIO CALL SIGN

Currently the FCC does not require recreational boaters to have a Ship Radio Station License. The USCG recommends the boats registration number and the state to be used when calling another vessel.

21.3 CANADIAN SHIP STATION LICENSING

You may need a license when traveling in Canada. If you do need a license contact their nearest field office or regional office or write:

**Industry Canada
Radio Regulatory Branch
Attn: DOSP
300 Slater Street
Ottawa, Ontario
Canada, KIA 0C8**

21.4 FCC / INDUSTRY CANADA INFORMATION

The following data pertaining to the transceiver is necessary to fill out the license application.

Type Acceptance FCC Part 80
Output Power 1 Watt (low) and 25 Watts (high)
Emission 16K0G3E, 16K0G2B
Frequency Range 156.025 to 163.275 MHz
FCC Type Number K6630443X3D
Industry Canada Type Approval 511B-30443X3D

22 FCC NOTICE

NOTICE

Unauthorized changes or modifications to this equipment may void compliance with FCC Rules. Any change or modification must be approved in writing by STANDARD HORIZON.

NOTICE

This equipment has been tested and found to comply with the limits for a Class B digital device, pursuant to Part 15 of the FCC Rules. These limits are designed to provide reasonable protection against harmful interference in a residential installation. This equipment generates, uses and can radiate radio frequency energy and, if not installed and used in accordance with the instructions, may cause harmful interference to radio communications. However, there is no guarantee that interference will not occur in a particular installation. If this equipment does cause harmful interference to radio or television reception, which can be determined by turning the equipment off and on, the user is encouraged to try to correct the interference by one or more of the following measures:

- Reorient or relocate the receiving antenna.
- Increase the separation between the equipment and receiver.
- Connect the equipment into an outlet on a circuit different from that to which the receiver is connected.
- Consult the dealer or an experienced radio/TV technician for help.

This device complies with part 15 of the FCC rules. Operation is subject to the condition that this device does not cause harmful interference.

Part 15.21: Changes or modifications to this device not expressly approved by Vertex Standard could void the User's authorization to operate this device.



**Marine Division of VERTEX STANDARD
US Headquarters**

10900 Walker Street, Cypress, CA 90630, U.S.A.

www.standardhorizon.com



E C 0 4 4 N 2 5 1

Copyright 2011
VERTEX STANDARD CO., LTD.
All rights reserved.

No portion of this manual
may be reproduced
without the permission of
VERTEX STANDARD CO., LTD.

Printed in China