

STANDARD HORIZON

Nothing takes to water like Standard Horizon

HX300

Floating VHF FM Marine Transceiver

Owner's Manual













TABLE OF CONTENTS

Quick Reference Guide.....	3
1. GENERAL INFORMATION.....	4
1.1 INTRODUCTION.....	4
1.2 SAFETY INFORMATION.....	5
2. ACCESSORIES.....	6
2.1 PACKING LIST.....	6
2.2 OPTIONS.....	6
3. ABOUT THIS RADIO.....	8
3.1 ABOUT THE VHF MARINE BAND.....	8
3.2 ABOUT WATER RESISTANCE.....	8
3.3 DISTRESS AND HAILING (CHANNEL 16).....	8
3.4 CALLING ANOTHER VESSEL (CHANNEL 16 OR 9).....	9
3.5 OPERATING ON CHANNEL 13.....	10
3.6 OPERATING ON CHANNEL 67.....	10
3.7 SIMPLEX / DUPLEX CHANNEL USE.....	10
3.8 AUTOMATED RADIO CHECK SERVICE.....	11
4. GETTING STARTED.....	12
4.1 RADIO CARE.....	12
4.2 BATTERIES AND CHARGERS.....	12
4.2.1 BATTERY SAFETY.....	13
4.2.2 BATTERY INSTALLATION / REMOVAL.....	14
4.2.3 BATTERY CHARGING.....	15
4.3 BELT CLIP INSTALLATION / REMOVAL.....	16
4.4 HAND STRAP INSTALLATION.....	16
4.4 INSTALLATION OF OPTION.....	17
4.4.1 FBA-44 ALKALINE BATTERY CASE.....	17
5. CONTROLS AND INDICATORS.....	18
5.1 CONTROLS AND SWITCHES.....	18
5.2 LCD INDICATORS.....	21
6. BASIC OPERATION.....	23
6.1 PROHIBITED COMMUNICATIONS.....	23
6.2 INITIAL SETUP.....	23
6.3 RECEPTION.....	23
6.4 TRANSMISSION.....	24
6.4.1 TRANSMIT TIME-OUT TIMER (TOT).....	24
6.4.2 WATER ENABLED LIGHT.....	24
6.5 USA, CANADIAN, AND INTERNATIONAL CHANNELS.....	25
6.6 KEYPAD LOCK.....	25
6.7 NOAA WEATHER CHANNELS.....	25
6.7.1 NOAA WEATHER ALERT.....	26
6.7.2 NOAA WEATHER ALERT TESTING.....	26
6.8 PRESET CHANNELS (0 ~ 9): INSTANT ACCESS.....	27
6.8.1 PROGRAMMING.....	27
6.8.2 OPERATION.....	27
6.8.3 DELETING A PRESET CHANNEL.....	27
6.9 SCANNING.....	28
6.9.1 PROGRAMMING SCAN MEMORY.....	28
6.9.2 SELECTING SCAN TYPE.....	28
6.9.3 OPERATION.....	29
6.9.3.1 Priority Scan.....	29
6.9.3.2 Memory Scan.....	30
6.10 DUAL WATCH.....	30
6.11 TRI-WATCH.....	31
7. MENU ("SET") MODE.....	32
8. MAINTENANCE.....	34
8.1 GENERAL.....	34
8.2 REPLACEMENT PARTS.....	34
8.3 FACTORY SERVICE.....	35
8.4 TROUBLESHOOTING CHART.....	35
9. VHF MARINE CHANNEL ASSIGNMENT.....	36
10. WARRANTY.....	42
11. SPECIFICATIONS.....	45
11.1 GENERAL.....	45
11.2 TRANSMITTER.....	45
11.3 RECEIVER.....	45
12. FCC AND CANADA RADIO LICENSE INFORMATION.....	46
13. FCC NOTICE.....	47

QUICK REFERENCE GUIDE

This transceiver is equipped with the E2O (Easy-To-Operate) system. You can do the basic operation in numerical order of the illustration below.



- ① Press and hold the  key to turn on or off the radio.
- ② Press the  key ("VOL" indicator blinks), then press the  key to adjust the speaker audio volume.
- ③ Press the  key to select the operating channel.
- ④ Press the  key two times ("SQL" indicator blinks), then press the  key to squelch or press the  key to un-squelch the radio.
- ⑤ Press the  key to toggle the transmit power between High (5W) and Low (1W).
- ⑥ Press the  key briefly to recall channel 16.
Press and hold the  key for two seconds to recall channel 9.
Press the  key again to revert to the last selected channel.
- ⑦ Place your mouth about 1 inch (2.5 cm) away from MIC hole and speak in a normal voice level while pressing the **PTT** switch.



1. GENERAL INFORMATION

1.1 INTRODUCTION

Congratulations on your purchase of the **HX300**! Whether this is your first portable marine VHF transceiver, or if you have other STANDARD HORIZON equipment, the STANDARD HORIZON organization is committed to ensuring your enjoyment of this high performance transceiver, which should provide you with many years of satisfying communications even in the harshest of environments. STANDARD HORIZON technical support personnel stands behind every product sold, and we invite you to contact us should you require technical advice or assistance by calling (800)767-2450 Monday through Friday 8AM to 5PM Pacific time.

The **HX300** is a Submersible Floating 5-Watt portable two way marine transceiver. The transceiver has all allocated USA, International, or Canadian channels. It has emergency channel 16 which can be immediately selected from any channel by pressing the  key. NOAA (National Oceanic and Atmospheric Administration) Weather channels can also be accessed immediately by press and holding the  key.

The **HX300** includes the following features: Memory Scanning, Priority Scanning, Dual and Tri-watch, NOAA Weather Alert, easy-to-read large LCD display, Battery Life displayed on LCD, the Water Enabled Light which blinks automatically when the radio comes in contact with water even if the radio is turned off, and a transmit Time-Out Timer (TOT).

The **HX300** transmitter provides a full 5 Watt of transmit power and also is selectable to 1 Watt to assist the user in ensuring maximum battery life.

We appreciate your purchase of the **HX300**, and encourage you to read this manual thoroughly, so as to learn and fully understand the capabilities of the **HX300**.

1.2 SAFETY INFORMATION

Your wireless handheld portable transceiver contains a low power transmitter. When the Push-to-Talk (PTT) button is pushed, the transceiver sends out radio frequency (RF) signals. In August 1996, the Federal Communications Commission adopted RF exposure guidelines with safety levels for handheld wireless devices.

This device is authorized to operate at a duty factor not to exceed 50% (this corresponds to 50% transmission time and 50% reception time).

WARNING: To maintain compliance with the FCC's RF exposure guidelines, this transmitter and its antenna must maintain a separation distance of at least 1 inch (2.5 centimeters) from your face. Speak in a normal voice, with the antenna pointed up and away from the face at the required separation distance.

Use only the supplied antenna. Unauthorized antennas, modifications, or attachments could damage the transmitter, and may violate FCC regulations.

2. ACCESSORIES

2.1 PACKING LIST

When the package containing the transceiver is first opened, please check it for the following contents:

- **HX300** Transceiver
- **CAT460** Antenna
- **FNB-122LI** 3.7 V, 1560 mAh Li-ion Battery Pack
- **PA-54B** USB Wall Charger (100-240 VAC, Type-A plug) and Cable
- **CLIP-22** Belt Clip
- Hand Strap
- Owner's Manual

2.2 OPTIONS

- ① **CN-3** Radio-to-Ship's-Antenna Adapter
- ② **FNB-122LI** 3.7 V, 1560 mAh Li-ion Battery Pack
- ③ **FBA-44** Alkaline Battery Case (3 x "AAA" Cell Size)
- ④ **PA-54B/C*** USB Wall Charger and Cable

※: "B" suffix has a Type-A plug, and "C" suffix has a Type-C plug. Both versions of the USB Wall Charger are available in 100-240 VAC.

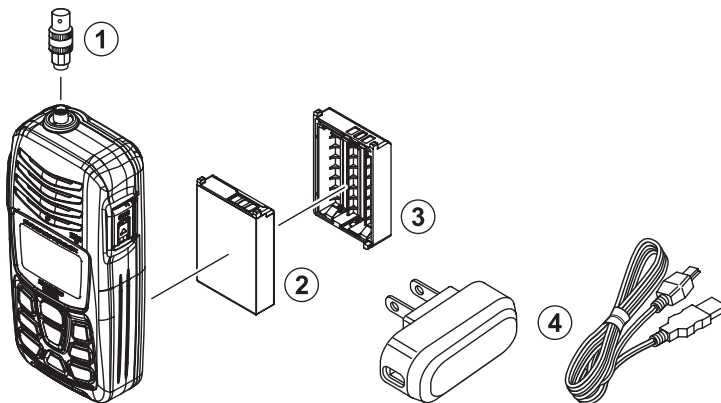

Note: Before operating the **HX300** for the first time, it is recommended that the battery be charged. Please see section "**4.2.3 BATTERY CHARGING**" for details.

3. ABOUT THIS RADIO

3.1 ABOUT THE VHF MARINE BAND

The radio frequencies used in the VHF marine band lie between 156 and 158 MHz with NOAA Weather stations available between 161 and 163 MHz. The marine VHF band provides communications over distances that are essentially “Line of sight” Actual transmission range depends much more on antenna type, gain and height than on the power output of the transmitter. On a fixed mount 25 W radio transmission expected distances can be greater than 15 miles, for a portable 5 W radio transmission the expected distance can be greater than 5 miles in “Line of sight”.

The user of a Marine VHF radio is subject to severe fines if the radio is used on land. The reasoning for this is you may be near an inland waterway, or propagation anomalies may cause your transmission to be heard in a waterway. If this occurs, depending upon the marine VHF channel on which you are transmitting, you could interfere with a search and rescue case, or contribute to a collision between passing ships. For VHF Marine channel assignments refer to section “**9 VHF MARINE CHANNEL CHART ASSIGNMENT**”.

WARNING

This radio is capable of transmitting on Marine VHF.

The FCC allows the use of VHF Marine band on water areas only. However the FCC does not allow the use of the VHF Marine band when on land. If persons use the VHF Marine Band on land and interfere with others communicating, the FCC will be notified and search for the interference. Responsible parties found to be transmitting on the VHF Marine Band on land could be fined up to \$10,000 for the first offense.

3.2 ABOUT WATER RESISTANCE

The **HX300** is only submersible* when the Battery Cover is latched and the Charge (**CHG**) Cover is snapped closed.

※ IPX8 Specification for submersibility: 5 ft. (1.5 m) for 30 minutes.

3.3 DISTRESS AND HAILING (CHANNEL 16)

Channel 16 is known as the Hail and Distress Channel. An emergency may be defined as a threat to life or property. In such instances, be sure the transceiver is on and set to “Channel 16”. Then use the following procedure:

1. Press the **PTT** (Push-To-Talk) switch and say “**Mayday, Mayday, Mayday**. This is _____, _____, _____” (your vessel’s name).
2. Then repeat once: “**Mayday, _____**” (your vessel’s name).

3. Now report your position in latitude/longitude, or by giving a true or magnetic bearing (state which) to a well-known landmark such as a navigation aid or geographic feature such as an island or harbor entry.
4. Explain the nature of your distress (sinking, collision, aground, fire, heart attack, life-threatening injury, etc.).
5. State the kind of assistance your desire (pumps, medical aid, etc.).
6. Report the number of persons aboard and condition of any injured.
7. Estimate the present seaworthiness and condition of your vessel.
8. Give your vessel's description: length, design (power or sail), color and other distinguishing marks. The total transmission should not exceed 1 minute.
9. End the message by saying "**OVER**". Release the **PTT** switch and listen.
10. If there is no answer, repeat the above procedure. If there is still no response, try another channel.

3.4 CALLING ANOTHER VESSEL (CHANNEL 16 OR 9)

Channel 16 may be used for initial contact (hailing) with another vessel.

However, its most important use is for emergency messages. This channel must be monitored at all times except when actually using another channel.

It is monitored by the U.S. and Canadian Coast Guards and by other vessels. Use of channel 16 for hailing must be limited to initial contact only. Calling should not exceed 30 seconds, but may be repeated 3 times at 2-minute intervals. In areas of heavy radio traffic, congestion on channel 16 resulting from its use as a hailing channel can be reduced significantly in U.S. waters by using Channel 9 as the initial contact (hailing) channel for non-emergency communications. Here, also, calling time should not exceed 30 seconds but may be repeated 3 times at 2-minute intervals.

Prior to making contact with another vessel, refer to the channel charts in this manual, and select an appropriate channel for communications after initial contact. For example, Channels 68 and 69 of the U.S. VHF Charts are some of the channels available to non-commercial (recreational) boaters. Monitor your desired channel in advance to make sure you will not be interrupting other traffic, and then go back to either channel 16 or 9 for your initial contact.

When the hailing channel (16 or 9) is clear, state the name of the other vessel you wish to call and then "**this is**" followed by the name of your vessel and your Station License (Call Sign). When the other vessel returns your call, immediately request another channel by saying "**go to**", the number of the other channel, and "**over**". Then switch to the new channel. When the new channel is not busy, call the other vessel.

After a transmission, say “**over**”, and release the **PTT** (Push-To-Talk) switch. When all communication with the other vessel is completed, end the last transmission by stating your Call Sign and the word “**out**”. Note that it is not necessary to state your Call Sign with each transmission, only at the beginning and end of the contact.

Remember to return to Channel 16 when not using another channel. Some radios automatically monitor Channel 16 even when set to other channels or when scanning.

3.5 OPERATING ON CHANNEL 13

Channel 13 is used at docks, bridges and for maneuvering in port. Messages on this channel must concern navigation only, such as meeting and passing in restricted waters. In emergencies and when approaching blind river bends, High power is allowed. Pressing the  key will change the power output from Low Power (1 Watt) to High (5 Watts). When you change from this channel then return to it, low power will be automatically selected.

3.6 OPERATING ON CHANNEL 67

When channel 67 is used for navigational bridge-to-bridge traffic between ships, Normal, High or Medium power may be used temporarily (in the USA band) by pressing the  key. When you select this channel again, the transceiver will revert to low power.

3.7 SIMPLEX/DUPLEX CHANNEL USE

Refer to the section “**9 VHF MARINE CHANNEL CHART ASSIGNMENT**” for instructions on use of simplex and duplex channels.

NOTE

All channels are factory-programmed in accordance with FCC (USA), Industry Canada and International regulations. The mode of operation cannot be altered from simplex to duplex or vice-versa. Simplex (ship to ship) or duplex (marine operator) mode is automatically activated, depending on the channel and whether the USA, International or Canadian operating band is selected.

3.8 AUTOMATED RADIO CHECK SERVICE

In areas across the country, Sea Tow offers boaters a way to conduct radio checks. To use Sea Tow's free Automated Radio Check service, simply tune your VHF radio to the appropriate channel for your location and conduct a radio check as you typically would. Upon releasing your radio's microphone, the system will play an automated message and relay your transmission back to you, thereby letting you know how your signal will sound to other boaters.

The Automated Radio Check Service is currently available in the areas listed below.

West Coast

Sea Tow Newport/LA - Ch. 27

Sea Tow San Diego - Ch. 27

Northeast

Sea Tow Portland-Midcoast (Maine) - Ch. 27

Sea Tow Boston - Ch. 27

Sea Tow South Shore (Mass.) - Ch. 28

Sea Tow Rhode Island - Ch. 24

Sea Tow Eastern Long Island - Ch. 27

Sea Tow Huntington (N.Y.) - Ch. 27

Sea Tow Manasquan (N.J.) - Ch. 28

Mid-Atlantic

Sea Tow Northern Chesapeake (Md.) - Ch. 28

Sea Tow Central Chesapeake (Md.) - Ch. 27

Sea Tow Hampton Roads (Va.) - Ch. 28

North Carolina

Sea Tow Wrightsville Beach - Ch. 28

Sea Tow Ocean Isle Beach - Ch. 28

Florida

Sea Tow Sebastian - Ch. 28

Sea Tow Fort Lauderdale - Ch. 27

Sea Tow Charlotte Harbor - Ch. 24

Sea Tow Tampa Bay - Ch. 27

Sea Tow Horseshoe Beach - Ch. 27

Sea Tow Carrabelle/St. Marks - Ch. 27

Sea Tow Pensacola/Orange Beach (Ala.) - Ch. 27

4. GETTING STARTED

4.1 RADIO CARE

CAUTION

Before following the instructions below, insure the battery pack is in place and the cover is latched. Care must be taken if the radio was dropped and a close inspection may be needed to insure the radio case and gaskets are in adequate condition.

After using the **HX300** in salt water environment is recommended to clean the radio with fresh by rinsing the radio under a sink faucet or by dunking the radio in a bucket of fresh water. After washing, use a soft cloth and thoroughly dry all parts of the radio. This is to keep the rubber switches and speaker grill clean and in top operating condition.

4.2 BATTERIES AND CHARGERS

If the radio has never been used, or its charge is depleted, it may be charged by connecting the **PA-54B** USB Wall Charger with the Charge Cable, see section “**4.2.3 BATTERY CHARGING**”. The **PA-54B** will charge a completely discharged **FNB-122LI** battery pack in about 6 hours.

If the USB port is available (such as your personal computer), You may charge the **FNB-122LI** battery pack by connecting the supplied Charge Cable between the **HX300** and USB port.

The **FNB-122LI** is a high performance Li-ion battery providing high capacity in a compact package.

FNB-122LI Rechargeable Battery Pack

Capacity	1560 mAh			
Nominal Voltage	3.7 V			
Temperature Range	Minimum		Maximum	
	°C	°F	°C	°F
Charge	5	41	35	95
Discharge	-20	-4	60	140
Storage	-10	14	35	95

CAUTION

To avoid risk of explosion and injury, **FNB-122LI** battery pack should only be removed, charged or recharged in non-hazardous environments.

4.2.1 BATTERY SAFETY

Battery packs for your transceiver contain Li-ion batteries. This type of battery stores a charge powerful enough to be dangerous if misused or abused, especially when removed from the transceiver. Please observe the following precautions:

DO NOT SHORT BATTERY PACK TERMINALS: Shorting the terminals that power the transceiver can cause sparks, severe overheating, burns, and battery cell damage. If the short is of sufficient duration, it is possible to melt battery components. Do not place a loose battery pack on or near metal surfaces or objects such as paper clips, keys, tools, etc. When the battery pack is installed on the transceiver, the terminals that transfer current to the transceiver are not exposed. The terminals that are exposed on the battery pack when it is mounted on the transceiver are charging terminals only and do not constitute a hazard.

DO NOT INCINERATE: Do not dispose of any battery in a fire or incinerator. The heat of fire may cause battery cells to explode and/or release dangerous gases.

Battery Maintenance

For safe and proper battery use, please observe the following:

- Battery packs should be charged only in non-hazardous environments;
- Use only STANDARD HORIZON-approved batteries;
- Exceeding the specified temperature limits;
- Reversing charge polarity. Use only the proper charger. If this is tampered with or another charger is used, permanent damage may result;
- Use only a STANDARD HORIZON approved charger. The use of any other charger may cause permanent damage to the battery.
- Follow charging instructions provided with the chargers.
- Submersing the battery in water, or attempting to open the battery casing.
- Keep the battery contacts clean.

Battery Storage

When a battery pack is not used for a long time, please remove it from the transceiver. Also, while in storage, the charge will drain slightly over time and the battery should be recharged each six months.

Store the batteries in a cool place to maximize storage life. Since batteries are subject to self-discharge, avoid high storage temperatures that cause large self-discharge rates. After extended storage, a full recharge is recommended.

Battery Recycling

**DO NOT PLACE USED BATTERIES IN YOUR REGULAR TRASH!
LI-ION BATTERIES MUST BE COLLECTED, RECYCLED
OR DISPOSED OF IN AN ENVIRONMENTALLY SOUND
MANNER.**



The incineration, land filling or mixing of Li-ion batteries with the municipal solid waste stream is PROHIBITED BY LAW in most areas.

Return batteries to an approved Li-ion battery recycler. This may be where you purchased the battery.

Contact your local waste management officials for other information regarding the environmentally sound collection, recycling and disposal of Li-ion batteries.

4.2.2 BATTERY INSTALLATION / REMOVAL

- Open the Battery Cover Latch on the bottom of the radio, then remove the Battery Cover from the radio while pulling the bottom side of the Battery Cover.
- Install the **FNB-122LI** Battery Pack into the radio, by carefully mating the battery's two alignment tabs on the top side of the Battery Pack with their corresponding alignment slots in the Battery Nest of the radio, then gently press the bottom side of the Battery Pack until it locks in place.
- Install the Battery Cover by carefully aligning the two tabs on the top of the cover with the slots on the radio, then gently press the bottom side of the Battery Cover. Confirm that a Rubber Gasket of the Battery Cover is installed correctly.
- Close the Battery Cover Latch until it locks in place with a "Click".

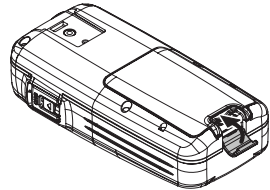
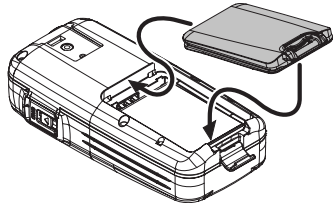
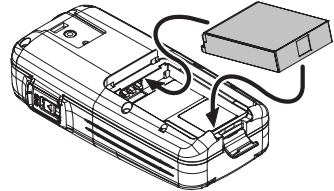



CAUTION

To insure the **HX300** will not have a problem with water intrusion, make sure the battery cover is properly installed and the battery latch is closed.

4.2.3 BATTERY CHARGING

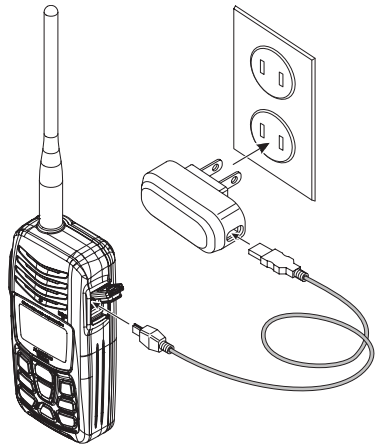
1. Turn the transceiver off.
2. Slide the **CHG** cover button (with arrow) up to open the **CHG** cover, then connect the supplied Charge Cable to the **CHG** jack on the **HX300**.
3. Connect the other side plug of the supplied Charge Cable to the **PA-54B**, then plug the **PA-54B** into the AC line outlet.
4. If the connection is correct, the “” and “**CHG**” icon will appear in the display. A fully-discharged pack will be charged completely in approximately 6 hours.



5. When charging is completed, the “” icon disappears and “FL” will appear in the display. Disconnect the Charge Cable from the **HX300** and close the **CHG** cover securely (make sure a click is heard), then unplug the **PA-54B** from the AC line outlet.

CAUTION

- When using the radio, make sure the **CHG** cover is completely closed to insure water integrity.
- The **PA-54B** is NOT designed to be waterproof. Do not attempt to charge in water hazardous locations.

NOTE

- The **HX300** may also be charged by connecting the USB cable to the radio and a USB connector on a PC. It will take about 6 hours to charge the battery and FL will be shown on the **HX300** display when charging is completed.
- The **PA-54B** is only designed for the charging of the **HX300**'s battery pack, and is not suitable for other purposes. The **PA-54B** may contribute noise to TV and radio reception in the immediate vicinity, so it do not recommend its use adjacent to such device.
- When carefully maintained, a pack should be useful for about 300 charge/discharge cycles.

4.3 BELT CLIP INSTALLATION / REMOVAL

- To install the Belt Clip: align the Belt Clip to the groove of the Battery pack, then press the Belt Clip downward until it locks in place with a “Click”.
- To remove the Belt Clip: press the Belt Clip Tab away from the battery pack to unlock the Belt Clip, then slide the Belt Clip upward to remove it.

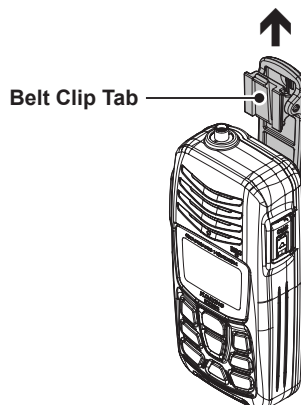
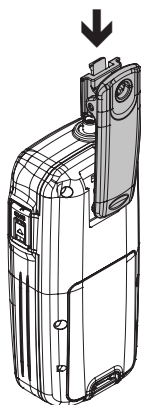

HAND STRAP INSTALLATION

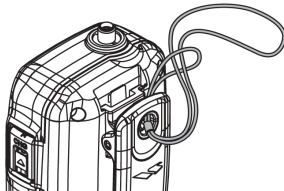

4.4 INSTALLATION OF OPTION

4.4.1 FBA-44 ALKALINE BATTERY CASE

FBA-44 is a Battery Case that holds three “AAA” size Alkaline Batteries and is used with the **HX300** transceiver.

CAUTION

To insure the **HX300** will not have a problem with water intrusion, make sure the battery cover is properly installed and the battery latch is closed.

IMPORTANT NOTE

The power output will be reduced to “Low Power” (1 W) automatically when using the **FBA-44**.

- ❑ Install the three “AAA” size Alkaline Batteries into the **FBA-44** Battery Case with the Negative (–) side of the batteries touching the spring connections inside the **FBA-44** Battery Case (Figure 1).
- ❑ Turn over the **FBA-44** Battery Case, then insert the **FBA-44** Battery Case into the Battery Compartment, by a same manner of the installation of the **FNB-122LI** (Figure 2).
- ❑ Re-install the Battery Cover (Figure 3), then close the Battery Cover Latch until it locks in place with a “Click” (Figure 4).

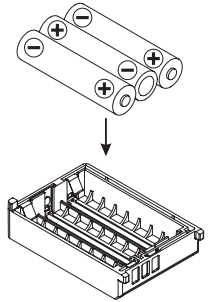

FIGURE 1

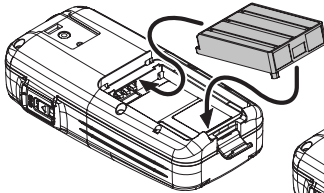

FIGURE 2

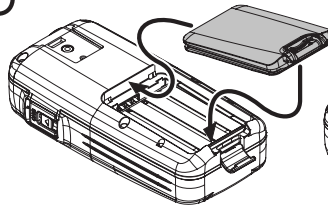

FIGURE 3

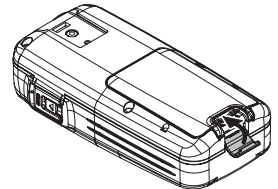

FIGURE 4

NOTE

- The **FBA-44** is designed for use only with “AAA” size Alkaline Cells. Do not attempt to install any rechargeable battery cell.
- If you do not use the **HX300** for a long time, remove the Alkaline batteries from the **FBA-44**, as battery leakage could cause damage to the **FBA-44** and/or **HX300**.

5. CONTROLS AND INDICATORS

5.1 CONTROLS AND SWITCHES

NOTE

This section defines each control of the transceiver. For detailed operating instructions, refer to section “**6 BASIC OPERATION**”. Refer to illustrations for the location of the following controls, switches, and connections.

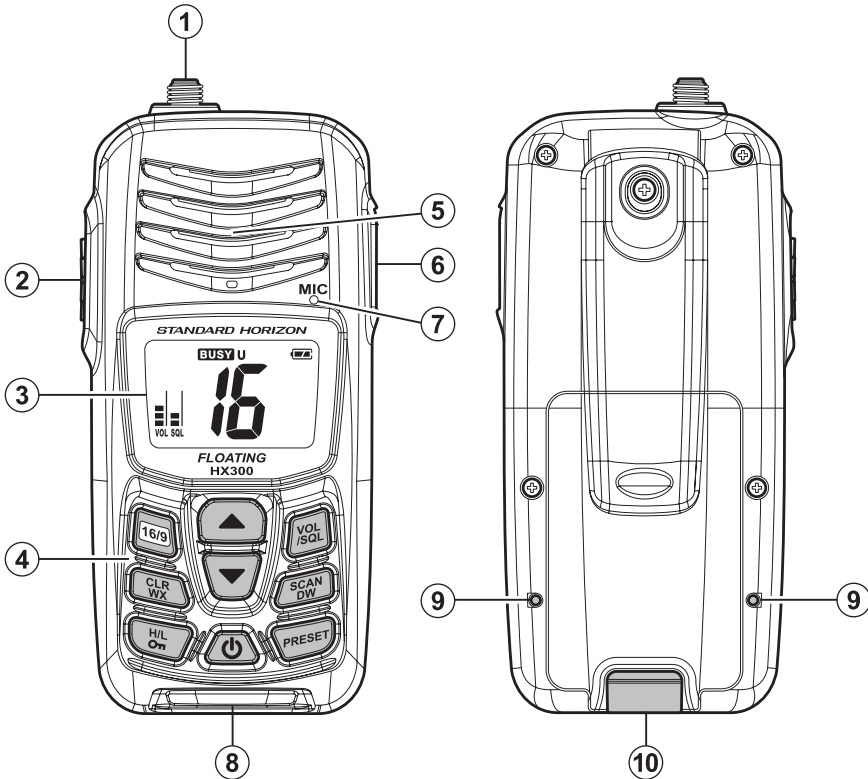

- ① **ANT Jack (Top Panel)**
The supplied **CAT460** flexible antenna is attached here.
- ② **PTT (PUSH-TO-TALK) Switch (Left Side Panel)**
When pushed activates the transmitter.
- ③ **LCD Display**
This display shows current operating conditions, as indicated on the page 21.

④ Keypad

Key

Pressing this key immediately recalls channel 16 from any channel location. Holding down this key recalls channel 9. Pressing this key again reverts to the previous selected working channel.



Key

Press to stop the Scan, Priority Scan, Dual or Tri-Watch feature.

Secondary use:

Press and hold this key to immediately recall the last-used NOAA (National Oceanic and Atmospheric Administration) Weather Channel from any channel location. Recalls the previously- selected working channel when the  key is pressed again.





Advanced use:

When the  key is held and the  key is pressed, the radio will change the marine band between the USA, International, and Canadian channels.

Key

Press this key to toggle the transmitter output power between “High” (5 Watts) and “Low” (1 Watt) power. This key does not function on the “Transmission Inhibited” and “Low power only” channels.

Secondary use:

Hold down this key to lock the keypad (except the ,  and **PTT** keys) so that they are not accidentally changed. The “” Keylock icon will appear at the top left on the display, to indicate that the functions are locked. Hold down this key until the “” Keylock icon disappears to unlock the radio.

Key

Press this key to change the operating channel, receiver volume level, and squelch threshold level.

Press the key momentarily, the channel (or level) will increase one step. Holding the key, the channel (or level) will increase continuously.

Key

Press this key to change the operating channel, receiver volume level, and squelch threshold level.

Press the key momentarily, the channel (or level) will decrease one step. Holding the key, the channel (or level) will decrease continuously.

Key

Press and hold this key for two seconds to turn the radio “on” or “off”.



Key

Press this key to toggle the operation mode from Speaker Volume adjustment, SQL adjustment, and Channel selection.

Secondary use:

- a. Press and hold this key to open the squelch, allowing you to monitor the operating channel. Release the key to resume normal (quiet) monitoring.
- b. Setup mode may be enabled. Refer section “**7. MENU (“SET”) MODE**” for details



Key

Starts scanning and priority scanning of channels programmed into memory. Refer to section “**6.9.1 PROGRAMMING SCAN MEMORY**”.

Secondary use:

- a. Press and hold the  key for two seconds to activate the Dual Watch feature.
- b. Used to program channels into Scan memory. Refer to section “**6.9.1 PROGRAMMING SCAN MEMORY**”.



Key

Immediately recalls one of up to 10 user preset memories for each band (shown as “0” - “9” on the LCD). Pressing this key repeatedly scrolls through the preset memory channels.

Secondary use:



Used to program channels into the Preset Channel memory. Refer to section “**6.8.1 PROGRAMMING**”.

- ⑤ Speaker
The internal speaker is located here.
- ⑥ CHG (Charge) Cover/Jack (Left Side Panel)
This mini-USB (Type-B) jack allows to connection to the supplied **PA-54B** USB Wall Charger with the supplied Charge Cable.
- ⑦ Microphone
The internal microphone is located here.
When transmitting, position your mouth about 1/2 to 1 inch (1.2 ~ 2.5 cm) away from the small mic hole. Speak slowly and clearly into the microphone.
- ⑧ Water Enabled Light
When the **HX300** comes in contact with water, the light will blink red to assist finding the radio in low light conditions. This feature operates when the radio is on or off. To setup the blinking of the light refer to section “**7.**”

MENU (“SET”) MODE”.

- ⑨ Water Enabled Light Terminals
These terminals are used to detect water to enable the Water Enabled Light.
When these terminals touch water, the Water Enabled Light blinks. Keep these terminals clean.
- ⑩ Battery Cover Latch (Bottom side)
Open the battery cover lock latch allows access to remove the Lithium-Ion battery or optional Alkaline battery tray.

5.2 LCD INDICATORS





- ① “**On**” Keylock Indicator
When the “**On**” Keylock icon is shown on the LCD, all keys are disabled except for the PTT, , and  keys.

- ② “**TX**” Indicator
This indicator appears during transmission.

- ③ “**BUSY**” Indicator
This indicator appears when a signal is being received or the radio is un-squelched.

- ④ “**U/I/C**” Indicator
These indicators show the “band” of operation. “**U**” indicates the USA band; “**I**” indicates the International band; and “**C**” indicates the Canadian band.

- ⑤ “**SCN**” Indicator
This indicator appears when the Scan is activated.

- ⑥ “” Battery Indicator
 - “” : Full battery
 - “” : Lower battery
 - “” : Battery is very low
 - “” (Blinking) : Prepare to charge the battery

- ⑦ “**PRESET**” Indicator
Shown when the channel is programmed into the Preset Channel memory.

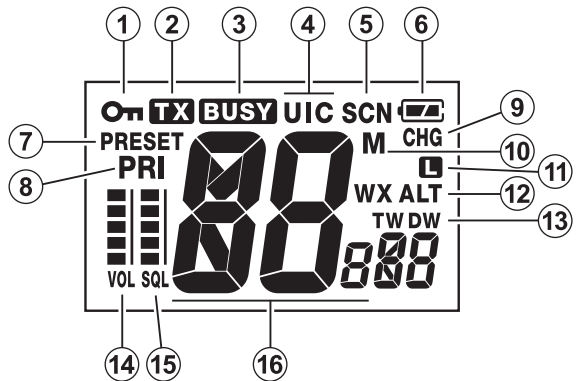

- ⑧ **“PRI”** Indicator
This indicator shows the channel is in the “Priority Channel”.
- ⑨ **“CHG”** (Charge) Indicator
This indicator appears during battery charging.
- ⑩ **“M”** Indicator
This indicator shows the channel is in the transceiver’s “Scan Memory”.
- ⑪ **“L”** Indicators
This indicator shows the TX output power is “Low” (1 Watt) power.

NOTE

When the “L” icon is not shown the power is set to 5 Watts.
--

- ⑫ **“WX ALT”** Indicator
“**WX**”: NOAA weather channel is selected.
“**WX ALT**”: “Weather Alert” is received.
- ⑬ **“TW DW”** Indicator
“**TW**”: Tri-Watch is activated.
“**DW**”: Dual Watch is activated.
- ⑭ **VOL** Indicator
This indicator shows the receive audio volume level.
- ⑮ **SQL** Indicator
This indicator shows the squelch level.
- ⑯ **Channel Display**
The operating channel is shown on the LCD in both the transmission and reception modes.

6. BASIC OPERATION

6.1 PROHIBITED COMMUNICATIONS















The FCC prohibits the following communications:

- False distress or emergency messages;
- Messages to “any boat” except in emergencies and radio tests;
- Messages to or from a vessel on land;
- Transmission while on land;
- Obscene, indecent, or profane language (potential fine of \$10,000).

6.2 INITIAL SETUP

1. Install the battery pack on the transceiver (see section “4.2.2 BATTERY INSTALLATION/REMOVAL”).
2. Install the antenna onto the transceiver; hold the bottom end of the antenna, then screw it onto the mating connector on the transceiver until it is snug. Do not over-tighten.

6.3 RECEPTION

1. Press and hold the  key for two seconds to turn the radio “on”.
2. Press the  key twice (“SQL” will be blinking).
3. While “SQL” is blinking, press the  key until the “BUSY” indicator will appear on the display, then press the  key.
4. Press the  key (“VOL” will be blinking).
5. While “VOL” is blinking, press the  key until the noise or audio from the speaker is at a comfortable level, then press the  key.
6. Activate the squelch adjusting mode by pressing the  key twice (the “SQL” indicator blinks). Press the  key until the random noise disappears, then press the  key. This state is known as the “Squelch Threshold”.
5. Press the  or  key to select the desired channel. Refer to section “9. VHF MARINE CHANNEL ASSIGNMENTS” for available channels.
6. When a signal is received, adjust the volume (press the  key, followed by the  key) to the desired listening level. The “BUSY” indicator in the LCD is displayed indicating that the channel is being used or the radio is not squelched.

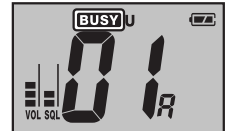
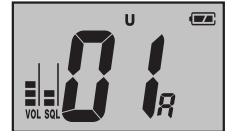
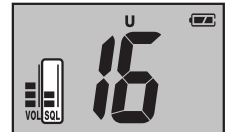
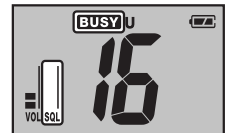

6.4 TRANSMISSION

1. Perform “**6.3 RECEPTION**” discussion above.
2. Before transmitting, monitor the channel and make sure it is clear.

THIS IS AN FCC REQUIREMENT!

3. For communications over short distances, press the  key to select the Low power (1 watt: “**L**” icon appears).

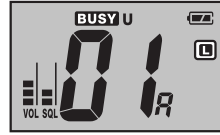

Note: Transmitting on Low power prolongs battery life. Low power should be selected whenever possible.

4. If using Low power is not effective, select High power (5 watts: “**L**” icon is not shown) by pressing the  key.
5. When receiving a signal, wait until communications stops before transmitting.

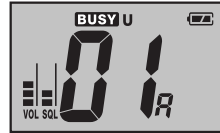

NOTE

The transceiver cannot transmit and receive simultaneously.

6. Press the **PTT** (Push-To-Talk) switch to transmit. During transmission, the “**TX**” indicator will appear on the display.
7. Position your mouth about 1/2 to 1 inch (1.2 ~ 2.5 cm) away from the mic hole on the top right above the display. Speak slowly and clearly into the microphone.
8. When the transmission is finished, release the **PTT** switch.

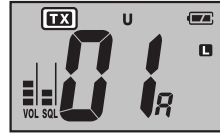

6.4.1 TRANSMIT TIME - OUT TIMER (TOT)



While the **PTT** switch is held down, transmission time is limited to 5 minutes. This prevents prolonged (unintentional) transmissions. About 10 seconds before automatic transmitter shutdown, a warning beep will sound from the speaker. The transceiver automatically switches to the receiving mode, even if the **PTT** switch is held down. Before transmitting again, the **PTT** switch must first be released, then wait 10 seconds and then pressed again. This Time-Out-Timer (TOT) prevents a continuous transmission that would result from an accidentally stuck **PTT** switch.

WATER ENABLED LIGHT

When the **HX300** comes in contact with water a red light will blink to assist retrieving it in low light conditions. The light will automatically turn off in about 15 seconds when it is removed from water.

The HX300 has a menu selection to enable, disable and select different blinking light times. Refer to Menu Mode Item “**FL (WATER ENABLED LIGHT)**” on page 33 for details.

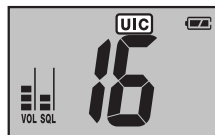

6.5 USA, CANADIAN, AND INTERNATIONAL CHANNELS

1. To change from US to International or Canadian Marine Channels, hold down the  key and press the  key. The band will change from USA, to International, and to Canadian with each press.
2. “U” appears on the LCD for the USA band, “I” appears for the International band, and “C” appears for the Canadian band
3. Refer to the marine channel charts in section “9. VHF MARINE CHANNEL ASSIGNMENTS” for allocated channels.



6.6 KEYPAD LOCKING



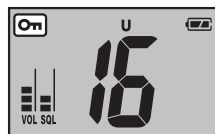

In order to prevent accidental channel change, the **HX300**'s keypad may be locked.

Hold down the  key to lock the keypad (except the **PTT**, , and  keys) so that they are not accidentally changed. The “**On**” icon will appear on the channel number of the display, to indicate that the functions are locked.



Hold down the  key until the “**On**” icon disappears to unlock the radio.





6.7 NOAA WEATHER CHANNELS

1. To receive a NOAA (National Oceanic and Atmospheric Administration) weather broadcast, press and hold the  key for two seconds. The transceiver changes to the weather channel mode and the radio will be set to the last used NOAA weather channel. This mode consists of a preset memory bank containing the NOAA weather channels.
2. Press the  or  key to change to other weather channels.
3. To exit from the weather channel mode, press and hold the  key for two seconds. The transceiver will revert to the channel you were using prior to switching to the weather channel mode.









6.7.1 NOAA WEATHER ALERT

To set the radio to decode a NOAA Weather Alert while on a channel:

1. Press the  key, then press the  or  to choose the weather channel in your area.
2. Press the  key.

The **HX300** can be set up to alert while in Scan or Priority scan modes. To memorize the weather channel:

1. Press and hold the  key, then press the  or  key to select the weather channel in your area.
2. Turn the radio off by pressing and holding the  key.
3. Press and hold the  key, then press and hold the  key. The display will show “SET” in the top left corner of the display.
4. Confirm the WX channel selected in step on is shown and press the  key to memorize the WX channel (“M” is shown to the right of the channel number).
5. Refer to programming 6.9 Scanning to program additional channels and selecting Memory Scan or Priority Scan.

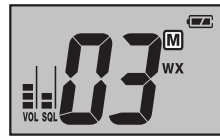
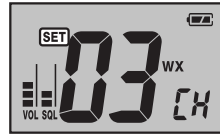

When a “Weather Alert” is received on a weather channel, the transceiver emits a beep tone and “WX ALT” icon is shown on the display. Press the  key to stop the beep tone and listen to the weather reports.

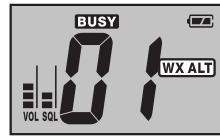

NOTE

Options for the Weather Alert feature are available, refer to Menu Mode Item “AL (WX ALERT)” on page 33 for details.

6.7.2 NOAA WEATHER ALERT TESTING







In the event of a major storm or other appreciable weather condition requiring vessels at sea (or other bodies of water) to be notified, the NOAA (National Oceanographic and Atmospheric Administration) broadcasts a 1050 Hz tone that some VHF radios, including your transceiver, can detect for “Weather Alarm” purposes (refer to section “6.7.1 NOAA WEATHER ALERT” for a discussion of how to use this feature). The 1050 Hz tone, when detected, will produce a loud beep in the speaker of the transceiver, to signal that a Weather Alert Broadcast is being received.

In order to test this system, NOAA broadcasts the 1050 Hz tone every Wednesday sometime between 11 AM and 1 PM local time. You may use this opportunity to test your transceiver periodically to confirm that the Weather Alert feature is working, or for training crew members on how to configure the transceiver to receive the NOAA Weather Alerts.

6.8 PRESET CHANNELS (0 ~ 9): INSTANT ACCESS



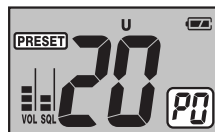
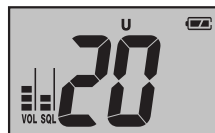

Ten user assigned channels can be programmed for instant access. Pressing the  key activates the user assigned channel (Preset Channel Bank).

6.8.1 PROGRAMMING

1. Select the desired channel to be assigned into the Preset Channel Bank using the  or  key.
2. Press and hold the  key until the “PRESET” icon blinks at the left of the channel number on the display.
3. Press the  or  key to select the desired Preset Channel (“P0” ~ “P9”).
4. Press the  key to program the current channel into the Preset Channel Bank.
5. Repeat steps 1 through 4 to program the other channel into Preset Channels, if desired.





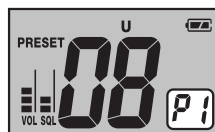
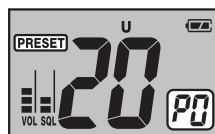

6.8.2 OPERATION

1. Press the  key to recall the Preset Channel. The “PRESET” icon and Preset Channel Number will appear on the display.
2. Press the  or  key to select the desired Preset Channel (“P0” ~ “P9”).
3. Press the  key again to return to the last selected channel. The “PRESET” icon will disappear from the display.



6.8.3 Deleting a Preset Channel

1. Press the  key to recall the Preset Channel.
2. Press the  or  key to select the Preset Channel to be deleted.
3. Press and hold the  key until the “PRESET” icon is blinking.
4. Press and hold the  key until “PRESET” icon indication is removed from the display.
5. Repeat steps 2 through 4 to delete the desired channels from Preset Channels “0” ~ “9”.

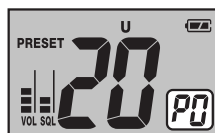
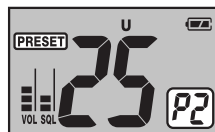











- To finish the deleting the Preset Channel, press the  key again to return to the last selected normal channel.

6.9 SCANNING





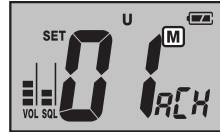
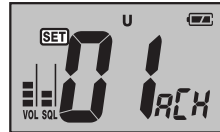

The **HX300** allows the user to select the scan type from “Memory Scan” or “Priority Scan”. “Memory Scan” scans the channels that were programmed into Scan Memory and also channels stored in the Preset Channel (“P0” ~ “P9”). “Priority Scan” is similar to the “Memory Scan” scan, however it scans the priority channel (channel 16) and dual watches to channels programmed in memory scan and preset channel memory. When an incoming signal is detected on one of the channels during scan, the radio will pause on that channel, allowing you to listen to the incoming transmission.

6.9.1 PROGRAMMING SCAN MEMORY

- Turn the transceiver off by press and holding the  key.
- Hold down the  key, and then turn on the transceiver while still holding down the  key. “SET” icon will appear on top right of the display.
- Press the  or  key to select desired channel to be scanned, then press the  key. The “M” icon appears on the display, which indicates the channel has been selected to the scan channel.
- Repeat step 3 for all desired channels to be programmed into scan memory.
- To DELETE a channel from the scan memory, select the channel by pressing the  or  key, then press the  key. The “M” icon disappears from the display.
- When you have completed programming scan memory, turn the transceiver off and on by press and holding the  key.



6.9.2 SELECTING SCAN TYPE

- Turn the transceiver off by press and holding the  key.
- Hold down the  key, and then turn on the transceiver while still holding down the  key.
- “SET” icon will appear on the display, indicating the Menu (“Set”) Mode has been activated.
- Press the  key until “SC” is shown in the bottom right of the display.
- Press the  or  key to select “PS (Priority Scan)” or “MS (Memory Scan)”. The factory default is “PS (Priority Scan)”.



Priority Scan: Scans the Scan Memory Channel, Preset Channel, and the Priority Channel (Channel 16).

Memory Scan: Scans the Scan Memory and channels programmed into the Preset Channel memory.



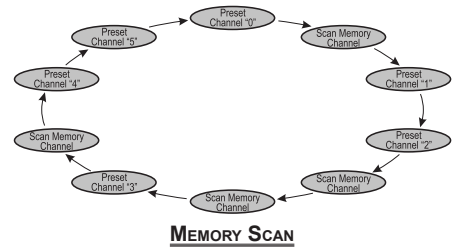
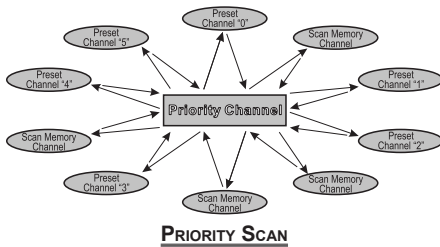
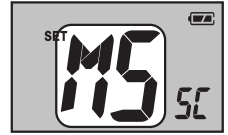
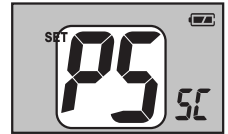

- After completing your selection, turn the transceiver off and on by press and holding the  key.



6.9.3 OPERATION



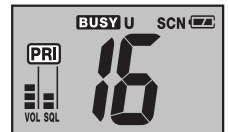
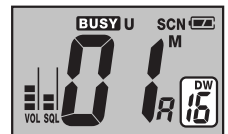
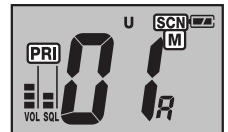

The operation of the “Priority Scan” or “Memory Scan” is determined via the section “6.9.2 SELECTING THE SCAN TYPE”

6.9.3.1 Priority Scan

- Press the  key two times until the “SQL” indicator blinks, to activate the squelch adjusting mode, then press the  key until the background noise disappears.
- Press the  key to start scanning, a “SCN” icon and blinking “PRI” and “M” icons will appear on the display during scanning.
- When the **HX300** receives a transmission on a working channel, it will stop on the working channel and “Dual Watch” (described in next chapter) to the priority channel until the incoming signal disappears, then start scanning again.
- When the **HX300** receives a signal on the Priority channel it will stay on this channel until the incoming signal disappears, then start Priority scanning again.
- To stop the scanning, press the  key.





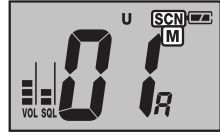

6.9.3.2 Memory Scan

1. Press the  key several times until the “SQL” indicator blinks, to activate the squelch adjusting mode, then press the  /  key until the background noise disappears.
2. Press the  key to start scanning, a “SCN” icon and blinking “M” icon will appear on the display during scanning.
3. When the **HX300** receives a transmission, it will stop on the channel until the incoming signal disappears, then start scanning again.
4. To stop the scanning, press the  key.



6.10 DUAL WATCH

The Dual Watch feature allows the radio watch the Priority Channel (Channel 16) and one other channel.



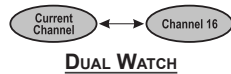
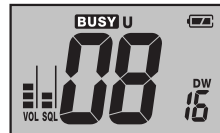
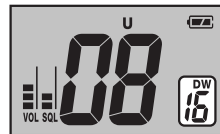

1. Select the desired channel using the  or  key.
2. Press and hold the  key for two seconds to activate the Dual Watch feature. A “DW” icon will appear on the display when the Dual Watch feature is activated.
3. When a transmission is received on the “Priority Channel”, the radio receives the “Priority Channel” until the incoming signal disappears.
4. When the **HX300** receives a transmission on the working channel, the radio will dual watch between the working channel and Priority Channel (Channel 16).
5. The Dual Watch feature will resume when the incoming signal disappears at the end of the transmission.
6. To stop the Dual Watch feature and return to normal operation, press and hold the  key for two seconds again.



6.11 TRI-WATCH

You may change the Dual Watch feature to Tri-Watch via the Menu (“Set”) Mode. Refer to Menu Mode Item “dt (DUAL WATCH MODE)” on page 33 for details.

The Tri-Watch scans Channel 16, 9, and one other channel. When enabled, a “TW” icon will appear on the display when the Dual Watch feature is activated.



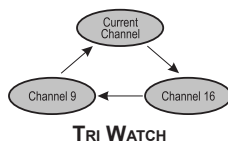
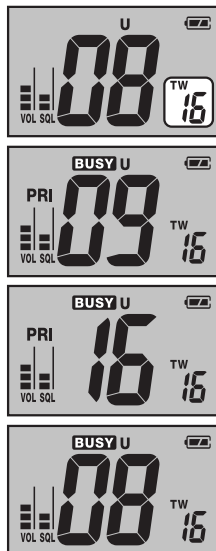





1. Press the  /  key to select the channel to scan along with Channel 9 and 16.
2. Press and hold the  key for two seconds to activate the TRI-Watch feature. “TW” icon will appear on the display when the Tri-Watch feature is activated.
3. When a transmission is received on the channel 16, **HX300** will stay on the channel 16 until the incoming signal disappears.
4. When a transmission is received on the channel 9, the **HX300** will Dual watch between the channel 16 and channel 9.
5. When the **HX300** receives a transmission on the working channel, the **HX300** will Tri-watch between the working channel, channel 16, and channel 9.
6. To stop the Tri-watch feature and return to normal operation, press the  key.



7. MENU (“SET”) MODE

The **HX300**'s Menu Mode allows a number of the **HX300** operating parameters to be custom-configured.

The Menu Mode is easy to activate and set, using the following procedure:

1. Turn the transceiver off by press and holding the  key.
2. Hold down the  key, and then turn on the transceiver while still holding down the  key.
3. After “**SET**” icon appears on the display let go of both keys.
4. The  key when pressed scrolls through each menu item:
 - LP - Lamp mode,
 - bP - key beep,
 - SC - Scan Mode,
 - dt - Dual watch or Tri-Watch mode,
 - FL - Water Enabled Strobe Menu,
 - AL - Weather alert
5. Press the  or  key will change the selection of the selected menu item.
6. Press the  key to save the menu selection.
7. After completing your adjustment, turn the transceiver off and on by press and holding the  key.

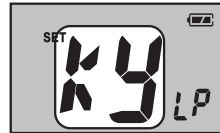

LP (LAMP MODE)

Function: Selects the Lamp illumination method for the LCD/Keypad.

Available Values: on / ky / of

Default: kEY

on: Illuminates the LCD/Keypad continuously.

ky: Illuminates the LCD/Keypad for 5 seconds when any key is pressed.

oF: Turns off the backlight for the LCD and keys.



bP (BEEP)

Function: Enable/Disable the Keypad beeper.

Available Values: HI / Lo / of

Default: HI



SC (SCAN TYPE)

Function: Selects the Scan mode.

Available Values: PS (Priority Scan) / MS (Memory Scan)

Default: PS (Priority Scan)

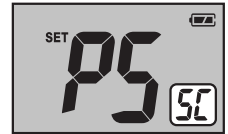

dt (DUAL WATCH MODE)

Function: Selects dual or tri-watch as desired.

Available Values: du (Dual Watch) / tr (Tri Watch)

Default: d (Dual Watch)

tr (Tri Watch): The **HX300** watches the activity of Channel 16, Channel 9, and the current channel.

du (Dual Watch): The **HX300** watches the activity of the current channel and the Channel 16.

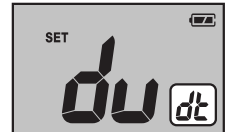

FL (WATER ENABLED LIGHT)

Function: Enables the water enabled light when the **HX300** comes in contact with water with the radio on or off. The light will turn on with the radio off or turned on.

Available Values: F1 / F2 / F3 / F4 / SO (SOS) / OF (OFF)

Default: F1

F1: Blinks slowly.

F2: Blinks fast.

F3: Blinks Medium.

F4: Blinks Rapidly.

SO: Blinks "S.O.S" Morse Code (••• --- •••).

OF: Disables the Water Enabled Light.



AL (WX ALERT)

Function: Enable/Disable the Weather Alert feature.

Available Values: on / oF

Default: on

on: Enables the Weather Alert function.

oF: Disables the Weather Alert function.



8. MAINTENANCE

8.1 GENERAL

The inherent quality of the solid-state components in STANDARD HORIZON radios will provide many years of continuous use. Take the following precautions to prevent damage to the radio.

- To prevent corrosion of electrical contacts and keep the water resistance, keep the battery cover latched and the charge cover closed while boating.
- Never press the **PTT** switch unless an antenna or suitable dummy load is connected to the antenna receptacle.
- Use only STANDARD HORIZON-approved accessories and replacement parts.

8.2 REPLACEMENT PARTS

Occasionally an owner needs a replacement part. Items can be ordered from our Parts Department by writing or calling (in USA or Canada), or Standard Horizon/Vertex Standard authorized dealers (outside USA or Canada).

YAESU USA

6125 Phyllis Drive, Cypress, California 90630

Telephone (800) 767-2450

Commonly requested parts, and their part numbers are listed below.

- **CAT460** Antenna: AY139X001
- **PA-54B** USB Wall Charger: Q9500197
- Charger Cable: T9101606
- Battery Cover: RA1377600
- **CLIP-22** Belt Clip: 365B258020
- Hand Strap: S6000418

8.3 FACTORY SERVICE

In the unlikely event that the radio fails to perform or needs servicing, please contact the following:

For repairs In USA

Standard Horizon

Attention Marine Repair Department
6125 Phyllis Drive, Cypress, California 90630
Telephone (800) 366-4566









For repairs in Canada

Westcom Marine

488 East 62nd Avenue
Vancouver BC V5X2G1
Phone (604)327-6280

An "RA" Return Authorization number is not necessary to send a product in for service. Include a brief note describing the problem along with your name, return address, phone number, and proof of purchase.

8.4 TROUBLESHOOTING CHART

SYMPTOM	PROBABLE CASE	REMEDY
The  key does not start the scan.	No channel memorized.	Enter desired channels into the transceiver's Scan memory. Refer to section 6.9.1 "PROGRAMMING SCAN MEMORY".
	Squelch is not adjusted.	Press the  key several times until the "SQL" indicator blinks, then press the  key until the "BUSY" icon disappears. Further adjustment of the squelch level may eliminate incoming signal.
Cannot select between USA, INTL, Canadian bands.	Proper operation not followed.	Hold down the  key and press the  key.
Speaker audio is not heard when the  key is press and hold.	Low battery.	Charge battery. Refer to section 4.2.3 "BATTERY CHARGING".
	Audio volume is too low.	Press the  key several times until the "VOL" indicator blinks, then press the  key several times.
Some keys does not operate.	Key lock is on.	Hold down the  key for 2 seconds to turn the Key Lock off.
"CHG" indicator on the LCD does not appear while charging.	Detective battery FNB-122LI .	Contact your Standard Horizon dealer.

9. VHF MARINE CHANNEL ASSIGNMENTS

Tables on the following columns list the VHF Marine Channel assignments for USA. and International use. Below are listed some data about the charts.

1. VTS. Where indicated, these channels are part of the U.S. Coast Guard's Vessel Traffic System.
2. Alpha channel numbers, that is, channel numbers followed by the letter A (such as Channel 07A) are **simplex** channels on the USA. or Canadian channel assignments whose counterparts in the International assignments are **duplex** channels. International channels do not use "alpha" numbers. If you call the Coast Guard on Channel 16, they will sometimes ask you to "**go to channel 22 Alpha.**" This is a channel assigned to USA, and Canadian Coast Guards for handling distress and other calls. If your radio is set for **International** operation you will go to Channel 22 instead of 22A, and will not be able to communicate with the Coast Guard. To use Channel 22A, your radio must be set for **USA** or **Canada** operation, usually by a U/I/C (USA/International/Canada) control or combination of controls. Channel 22 (without an "A") is an **International** duplex channel for port operations. Some radios indicate an "A" adjacent to the alpha channels on the display; on others "alpha" is not indicated but the proper channel is selected based on the U/I/C setting.
3. Bridge-to-Bridge channels (for example, Channel 13) are for use by bridge operators on inter-coastal waterways and rivers. It is also used by marine vessels in the vicinity of these bridges for navigation and for communicating with the bridge operators. Note that a limit of 1 Watt is specified for these channels.
4. The **S/D** column on the chart indicates either S (simplex) or D (duplex). **Simplex** means transmitting and receiving on the same frequency. Only one party at a time can talk, unlike a telephone. Be sure to say "**over**" and release your microphone push-to-talk switch at the end of each transmission. **Duplex** operation involves the use of one frequency for transmitting and a separate frequency for receiving. On channels specified as duplex on the charts, correct mode of operation is established automatically by your radio when you select a channel; you cannot change the mode. And you still must release the push-to-talk switch after each transmission in order to listen to the radio.
5. Channels normally used by recreational boaters are those that include the term "non-commercial" in the **Channel Use** column of the chart. Some of these are shared with other users and some are used only in certain geographic regions.

6. Marine vessels equipped with VHF radios are required to monitor Channel 16.
7. 156.050 MHz and 156.175 MHz are available for port operations and commercial communications purposes when used only within the U.S. Coast Guard designated Vessel Traffic Services (VTS) area of New Orleans, on the lower Mississippi River from the various pass entrances in the Gulf of Mexico to Devil's Swamp Light at River Mile 242.4 above head of passes near Baton Rouge.
8. 156.250 MHz is available for port operations communications use only within the U.S. Coast Guard designated VTS radio protection areas of New Orleans and Houston described in Sec. 80.383. 156.250 MHz is available for intership port operations communications used only within the area of Los Angeles and Long Beach harbors, within a 25- nautical mile radius of Point Fermin, California.
9. 156.550 MHz, 156.600 MHz and 156.700 MHz are available in the U.S. Coast Guard designated port areas only for VTS communications and in the Great Lakes available primarily for communications relating to the movement of ships in sectors designated by the St. Lawrence Seaway Development Corporation or the U.S. Coast Guard. The use of these frequencies outside VTS and ship movement sector protected areas is permitted provided they cause no interference to VTS and ship movement communications in their respective designated sectors.
10. Use of 156.875 MHz is limited to communications with pilots regarding the movement and docking of ships. Normal output power must not exceed 1 watt. 5: 156.375 MHz and 156.650 MHz are available primarily for intership navigational communications. These frequencies are available between coast and ship on a secondary basis when used on or in the vicinity of locks or drawbridges. Normal output power must not exceed 1 watt. Maximum output power must not exceed 10 watts for coast stations or 25 watts for ship stations.
11. On the Great Lakes, in addition to bridge-to-bridge communications, 156.650 MHz is available for vessel control purposes in established vessel traffic systems. 156.650 MHz is not available for use in the Mississippi River from South Pass Lighted Whistle Buoy "2" and Southwest Pass entrance Mid-channel Lighted Whistle Buoy to mile 242.4 above Head of Passes near Baton Rouge. Additionally it is not available for use in the Mississippi River-Gulf Outlet, the Mississippi River-Gulf Outlet Canal, and the Inner Harbor Navigational Canal, except to aid the transition from these areas.
12. Use of 156.375 MHz is available for navigational communications only

in the Mississippi River from South Pass Lighted Whistle Buoy "2" and Southwest Pass entrance Mid channel Lighted Whistle Buoy to mile 242.4 above head of Passes near Baton Rouge, and in addition over the full length of the Mississippi River-Gulf Outlet Canal from entrance to its junction with the Inner Harbor Navigation Canal, and over the full length of the Inner Harbor Navigation Canal from its junction with the Mississippi River to its entry to Lake Pontchartrain at the New Seabrook vehicular bridge.

13. Within 120 km (75 miles) of the United States/Canada border, in the area of the Puget Sound and the Strait of Juan de Fuca and its approaches, 157.425 MHz is half of the duplex pair designated as Channel 88. In this area, Channel 88 is available to ship stations for communications with public coast stations only. More than 120 km (75 miles) from the United States/Canada border in the area of the Puget Sound and the Strait of Juan de Fuca, its approaches, the Great Lakes, and the St. Lawrence Seaway, 157.425 MHz is available for intership and commercial communications. Outside Puget Sound area and its approaches and the Great Lakes, 157.425 MHz is also available for communications between commercial fishing vessels and associated aircraft while engaged in commercial fishing activities.
14. When the frequency 156.850 MHz is authorized, it may be used additionally for search and rescue training exercises conducted by state or local governments.
15. The frequency 156.850 MHz is additionally available to coast stations on the Great Lakes for transmission of scheduled Coded Marine Weather Forecasts (MAFOR), Great Lakes Weather Broadcast (LAWEB) and scheduled Notices to Mariners or Bulletins. F3C and J3C emissions are permitted. Coast Stations on the Great Lakes must cease weather broadcasts which cause interference to stations operating on 156.800 MHz until the interference problem is resolved.
16. The frequency 157.100 MHz is authorized for search and rescue training exercises by state or local government in conjunction with U.S. Coast Guard stations. Prior U.S. Coast Guard approval is required. Use must cease immediately on U.S. Coast Guard request.
17. The duplex pair for channel 20 (157.000/161.600 MHz) may be used for ship to coast station communications.
18. Available for assignment to coast stations, the use of which is in accord with an agreed program, for the broadcast of information to ship stations concerning the environment.

VHF MARINE CHANNEL CHART							
CH	U	C	I	S/D	TX	RX	CHANNEL USE
01		X	X	D	156.050	160.650	Public Correspondence (Marine Operator)
01A	X			S	156.050		Port Operation and Commercial. VTS in selected areas
02		X	X	D	156.100	160.700	Public Correspondence (Marine Operator)
03		X	X	D	156.150	160.750	Public Correspondence (Marine Operator)
03A	X			S	156.150		U.S. Government Only, Coast Guard
04			X	D	156.200	160.800	Public Correspondence (Marine Operator), Port operation, ship movement
04A		X		S	156.200		Pacific coast: Coast Guard, East Coast: Commercial fishing
05			X	D	156.250	160.850	Public Correspondence (Marine Operator), Port operation, ship movement
05A	X	X		S	156.250		Port operation. VTS in Seattle
06	X	X	X	S	156.300		Inter-ship Safety
07			X	D	156.350	160.950	Public Correspondence (Marine Operator), Port operation, ship movement
07A	X	X		S	156.350		Commercial
08	X	X	X	S	156.400		Commercial (Inter-ship only)
09	X	X	X	S	156.450		Boater Calling channel, Commercial & Non-commercial (Recreational)
10	X	X	X	S	156.500		Commercial
11	X	X	X	S	156.550		Commercial. VTS in selected areas
12	X	X	X	S	156.600		Port operation. VTS in selected areas
13	X	X	X	S	156.650		Inter-ship Navigation Safety (Bridge-to-bridge)
14	X	X	X	S	156.700		Port operation. VTS in selected areas
15	X			S	---	156.750	Environmental (Receive only)
15		X	X	S	156.750		Commercial, non-commercial, ship movement (1 W)
16	X	X	X	S	156.800		International Distress, Safety and Calling
17	X	X	X	S	156.850		State Controlled (1 W)
18			X	D	156.900	161.500	Port operation, ship movement
18A	X	X		S	156.900		Commercial
19			X	D	156.950	161.550	Port operation, ship movement
19A	X			S	156.950		US: Commercial
19A		X		S	156.950		Coast Guard
20	X	X	X	D	157.000	161.600	Canadian Coast Guard Only, International: port operations and shipment
20A	X			S	157.000		Port operation
21			X	D	157.050	161.650	Port operation, ship movement
21A	X	X		S	157.050		U.S. Government Only, Canadian Coast Guard
22			X	D	157.100	161.700	Port operation, ship movement
22A	X	X		S	157.100		US and Canadian Coast Guard Liaison and aritime Safety Information Broadcasts announced on channel 16
23		X	X	D	157.150	161.750	Public Correspondence (Marine Operator)
23A	X			S	157.150		U.S. Government Only
24	X	X	X	D	157.200	161.800	Public Correspondence (Marine Operator)
25	X	X	X	D	157.250	161.850	Public Correspondence (Marine Operator)
26	X	X	X	D	157.300	161.900	Public Correspondence (Marine Operator)
27	X	X	X	D	157.350	161.950	Public Correspondence (Marine Operator)
28	X	X	X	D	157.400	162.000	Public Correspondence (Marine Operator)

VHF MARINE CHANNEL CHART

CH	U	C	I	S/D	TX	RX	CHANNEL USE
60		X	X	D	156.025	160.625	Public Correspondence (Marine Operator)
61			X	D	156.075	160.675	Public Correspondence (Marine Operator), Port operation, ship movement
61A	X	X		S	156.075		Public Coast: Coast Guard; East Coast: commercial fishing only
62			X	D	156.125	160.725	Public Correspondence (Marine Operator), Port operation, ship movement
62A		X		S	156.125		Public Coast: Coast Guard; East Coast: commercial fishing onl
63			X	D	156.175	160.775	Public Correspondence (Marine Operator), Port operation, ship movement
63A	X	X		S	156.175		Port Operation and Commercial. VTS in selected areas
64		X	X	D	156.225	160.825	Public Correspondence (Marine Operator), Port operation, ship movement
64A	X	X		S	156.225		Public Correspondence (Marine Operator), Port operation, ship movement
65			X	D	156.275	160.875	Public Correspondence (Marine Operator), Port operation, ship movement
65A	X	X		S	156.275		Port Operations
66			X	D	156.325	160.925	Public Correspondence (Marine Operator), Port operation, ship movement
66A	X	X		S	156.325		Port Operations
67	X	X	X	S	156.375		US: Commercial. Used for Bridge-to-bridge communi-cations in lower Mississippi River. Inter-ship only, Canada: Commercial fishing, S&R
68	X	X	X	S	156.425		Non-commercial (Recreational)
69	X	X	X	S	156.475		US: Non-commercial (Recreational), Canada: Commercial fishing only, International: Inter-ship, Port operations and Ship movement
70	X	X	X	S	156.525		Digital selective calling (voice communications not allowed)
71	X	X	X	S	156.575		US, Canada: Non-commercial (Recreational), International: Port operations and Ship movement
72	X	X	X	S	156.625		Non-commercial (Inter-ship only)
73	X	X	X	S	156.675		US: Port Operations, Canada: Commercial fishing only, International: Inter-ship, Port operations and Ship movement
74	X	X	X	S	156.725		US: Port Operations, Canada: Commercial fishing only, International: Inter-ship, Port operations and Ship movement
75	X	X	X	S	156.775		Port Operations (Inter-ship only) (1W)
76	X	X	X	S	156.825		Port Operations (Inter-ship only) (1W)
77	X	X		S	156.875		Port Operations (Inter-ship only) (1W)
77			X	S	156.875		Port Operations (Inter-ship only)
78			X	D	156.925	161.525	Public Correspondence (Marine Operator), Port operation, ship-movement
78A	X	X		S	156.925		Non-commercial (Recreational)
79			X	D	156.975	161.575	Port operation and Ship movement
79A	X	X		S	156.975		Commercial

VHF MARINE CHANNEL CHART							
CH	U	C	I	S/D	TX	RX	CHANNEL USE
80			X	D	157.025	161.625	Port operation, ship movement
80A	X	X		S	157.025		Commercial
81			X	D	157.075	161.675	Port operation, ship movement
81A	X			S	157.075		U.S. Government Only - Environmental protection operations
81A		X		S	157.075		Canadian Coast Guard Only
82			X	D	157.125	161.725	Public Correspondence (Marine Operator), Port operation, ship movement
82A	X	X		S	157.125		U.S. Government Only, Canadian Coast Guard Only
83		X		D	157.175	161.775	Canadian Coast Guard Only
83			X	D	157.175	161.775	Public Correspondence (Marine Operator)
83A	X	X		S	157.175		U.S. Government Only, Canadian Coast Guard Only
84	X	X	X	D	157.225	161.825	Public Correspondence (Marine Operator)
85	X	X	X	D	157.275	161.875	Public Correspondence (Marine Operator)
86	X	X	X	D	157.325	161.925	Public Correspondence (Marine Operator)
87		X	X	S	157.375		Port operation, ship movement
87A	X			S	157.375		Public Correspondence (Marine Operator)
88		X	X	S	157.425		Port operation, ship movement
88A	X			S	157.425		Commercial, Inter-ship Only
WX01	X	X	X	D	---	162.550	Weather (receive only)
WX02	X	X	X	D	---	162.400	Weather (receive only)
WX03	X	X	X	D	---	162.475	Weather (receive only)
WX04	X	X	X	D	---	162.425	Weather (receive only)
WX05	X	X	X	D	---	162.450	Weather (receive only)
WX06	X	X	X	D	---	162.500	Weather (receive only)
WX07	X	X	X	D	---	162.525	Weather (receive only)
WX08	X	X	X	D	---	161.650	Weather (receive only)
WX09	X	X	X	D	---	161.775	Weather (receive only)
WX10	X	X	X	D	---	163.275	Weather (receive only)

NOTE: Simplex channels, 03A, 21A, 23A, 61A, 64A, 81A, 82A and 83A CANNOT be lawfully used by the general public in U.S.A. waters.

10. WARRANTY

Marine Products Limited Warranty

PLEASE NOTE

The following "Limited Warranty" is for valid for products that have been purchased in the United States and Canada. For limited Warranty details outside the United States, contact the dealer in your country.

STANDARD HORIZON (a division of YAESU USA.) warrants, to the original purchaser only, each new Marine Communications Product ("Product") manufactured and/or supplied by STANDARD HORIZON against defects in materials and workmanship under normal use and service for a period of time from the date of purchase as follows:

Fixed Mount and Portable Transceivers

1 year - if purchased before 01/01/91

3 years - if purchased between 01/01/91 and 01/01/94

3 years Waterproof - if purchased after 01/01/94

Loud hailers

1 year - if purchased before 01/01/91

3 years - if purchased after 01/01/91

Associated Chargers

1 year - if purchased before 01/01/91

3 years - if purchased after 01/01/91

Associated Batteries - 1 year. Note: Batteries will be deemed defective only if storage capacity drops below 80% of rated capacity or if leakage develops.

Associated Accessories - 1 year. Includes: Microphones/Handsets, External Speakers, Antennas, Carrying Accessories, Power Supplies, and Signaling Boards.

To receive warranty service, the purchaser must deliver the Product, transportation and insurance prepaid, to STANDARD HORIZON (a division of YAESU USA.). Include proof of purchase indicating model, serial number, and date of purchase. STANDARD HORIZON will return the Product to the purchaser freight prepaid. Products purchased prior to January 1, 1991 will bear the STANDARD HORIZON warranty terms in effect prior to that date.

In the event of a defect, malfunction or failure of the Product during the warranty period, STANDARD HORIZON's liability for any breach of contract or any breach of express or implied warranties in connection with the sale of Products shall be limited solely to repair or replacement, at its option, of the Product or part(s) therein which, upon examination by STANDARD HORI-

ZON, appear to be defective or not up to factory specifications. STANDARD HORIZON may, at its option, repair or replace parts or subassemblies with new or reconditioned parts and subassemblies. Parts thus repaired or replaced are warranted for the balance of the original applicable warranty.

STANDARD HORIZON will not warrant installation, maintenance or service of the Products. In all instances, STANDARD HORIZON's liability for damages shall not exceed the purchase price of the defective Product.

This warranty only extends to Products sold within the 50 States of the United States of America and the District of Columbia.

STANDARD HORIZON will pay all labor to repair the product and replacement parts charges incurred in providing the warranty service except where purchaser abuse or other qualifying exceptions exist. The purchaser must pay any transportation expenses incurred in returning the Product to STANDARD HORIZON for service.

This limited warranty does not extend to any Product which has been subjected to misuse, neglect, accident, incorrect wiring by anyone other than STANDARD HORIZON, improper installation, or subjected to use in violation of instructions furnished by STANDARD HORIZON, nor does this warranty extend to Products on which the serial number has been removed, defaced, or changed. STANDARD HORIZON cannot be responsible in any way for ancillary equipment not furnished by STANDARD HORIZON which is attached to or used in connection with STANDARD HORIZON's Products, or for the operation of the Product with any ancillary equipment, and all such equipment is expressly excluded from this warranty. STANDARD HORIZON disclaims liability for range, coverage, or operation of the Product and ancillary equipment as a whole under this warranty. STANDARD HORIZON reserves the right to make changes or improvements in Products, during subsequent production, without incurring the obligation to install such changes or improvements on previously manufactured Products.

The implied warranties which the law imposes on the sale of this Product are expressly LIMITED, in duration, to the time period specified above. STANDARD HORIZON shall not be liable under any circumstances for consequential damages resulting from the use and operation of this Product, or from the breach of this LIMITED WARRANTY, any implied warranties, or any contract with STANDARD HORIZON. IN CONNECTION WITH THE SALE OF ITS PRODUCTS, STANDARD HORIZON MAKES NO WARRANTIES, EXPRESS OR IMPLIED AS TO THE MERCHANTABILITY OR FITNESS FOR A PARTICULAR PURPOSE OR OTHERWISE, EXCEPT AS EXPRESSLY SET FORTH HEREIN.

Some states do not allow the exclusion or limitation of incidental or consequential damages, or limitation on how long an implied warranty lasts, so the above limitations or exclusions may not apply. This warranty gives specific legal rights, and there may be other rights which may vary from state to state.

ONLY PRODUCTS SOLD ON OR AFTER JANUARY 1, 1991 ARE COVERED UNDER THE TERMS OF THIS LIMITED WARRANTY.

ON-LINE WARRANTY REGISTRATION

THANK YOU for buying STANDARD HORIZON (a division of YAESU USA.) products! We are confident your new radio will serve your needs for many years!

Please visit www.standardhorizon.com to register the **HX300** Marine VHF. It should be noted that visiting the Web site from time to time may be beneficial to you, as new products are released they will appear on the STANDARD HORIZON Web site.

Product Support Inquiries

If you have any questions or comments regarding the use of the **HX300**, you can visit the STANDARD HORIZON Web site to send an E-mail or contact the Product Support team at (800) 767-2450 ext 6300 M-F 8:00-5:00PST.

In addition to the warranty, STANDARD HORIZON includes a lifetime "flat rate" program to provide service after the warranty period has expired. If you wish to obtain the flat rate price for out-of-warranty repair, you must include the information on the Owner's Record with the unit when you return it to your Dealer or to STANDARD HORIZON.

Lifetime Flat Rate Service Program: For the original Owner only, for the lifetime of the unit, STANDARD HORIZON will repair the unit to original specifications.

Note: The flat rate amount is payable by the Owner only if STANDARD HORIZON or the STANDARD HORIZON Dealer determines that a repair is needed. After the repair, a 90-day warranty will be in effect from the date of return of the unit to the Owner.

This service program is not available for equipment which has failed as a result of neglect, accident, breakage, misuse, improper installation or modification, or water damage (depending on the product).

11. SPECIFICATIONS

Performance specifications are nominal, unless otherwise indicated, and are subject to change without notice.

11.1 GENERAL

Frequency Ranges:	TX: 156.025 MHz - 157.425 MHz RX: 156.050 MHz - 163.275 MHz
Channel Spacing:	25 kHz
Frequency Stability:	±5 ppm (-4 °F to +140 °F [-20 °C to +60 °C])
Emission Type:	16K0G3E
Antenna Impedance:	50 Ω
Operating Voltage:	3.7 V DC, Negative Ground
Current Consumption:	330 mA (Receive, Typical at AF MAX.) 20 mA (Standby) 2.3 A / 0.9 A (TX: 5 W / 1 W)
Battery Life (Approx.):	10 hours (5/5/90 duty cycle)
Operating Temperature:	-4 °F to +140 °F (-20 °C to +60 °C)
Case Size (W x H x D):	2.3" x 5" x 1.3" (59 x 128 x 33 mm) (w/o knob & antenna)
Weight (Approx.):	8.4 oz (240 g) (with FNB-122LI, Belt Clip, & Antenna)

11.2 TRANSMITTER

RF Power Output:	5 W / 1 W (@3.7 V)
Modulation Type:	Variable Reactance
Maximum Deviation:	±5 kHz
Spurious Emission:	-75 dBc typical
Microphone Impedance:	2 kΩ

11.3 RECEIVER

Circuit Type:	Double-Conversion Superheterodyne
Intermediate Frequencies:	1st: 21.7 MHz, 2nd: 450 kHz
Adjacent Channel Selectivity:	70 dB typical
Intermodulation:	68 dB typical
Hum & Noise Ratio:	40 dB typical
Sensitivity:	0.25 μV for 12 dB SINAD
Selectivity:	25 kHz (-70 dB)
AF Output (Internal SP):	600 mW @8 Ω for 10 % THD (@3.7 V)

Measured in accordance with TIA/EIA-603.

12. FCC AND CANADA RADIO LICENSE INFORMATION

Standard Horizon radios comply with the Federal Communication Commission (FCC) and Industry-Canada requirements that regulate the Maritime Radio Service.

MARITIME STATION LICENSE

An FCC ship station license is no longer required for any vessel traveling in U.S. waters which uses a VHF marine radio, RADAR or EPIRB, and which is not required to carry radio equipment. However, any vessel required to carry a marine radio on an international voyage, carrying a HF single side band radiotelephone or marine satellite terminal. FCC license forms, including applications for ship (605) and land station licenses can be downloaded via the Internet at www.fcc.gov/Forms/Form605/605.html. To obtain a form from the FCC, call (888) 225-5322.

MARINE RADIO CALL SIGN

Currently the FCC does not require recreational boaters to have a Ship Radio Station License. The USCG recommends the boats registration number and the state to be used.

CANADIAN SHIP STATION LICENSING

You may need a license when traveling in Canada. If you do need a license contact their nearest field office or regional office or write:

Industry Canada
Radio Regulatory Branch
Attn: DOSP
300 Slater Street
Ottawa, Ontario
Canada, KIA 0C8

FCC / INDUSTRY CANADA INFORMATION

The following data pertaining to the transceiver is necessary to fill out the license application.

FCC Type Accepted:..... Part 80
Output Power with FNB-122LI:..... 1.0/5.0 W (Low/High)
Emission:..... 16K0G3E
Frequency Range:.....156.025 to 163.275MHz
FCC Type Number:..... K6630493X20
Industry Canada Type Approval: 511B-30493X20

13. FCC NOTICE

NOTICE

Unauthorized changes or modifications to this equipment may void compliance with FCC Rules. Any change or modification must be approved in writing by STANDARD HORIZON, a division of YAESU USA.

NOTICE

This equipment has been tested and found to comply with the limits for a Class B digital device, pursuant to Part 15 of the FCC Rules. These limits are designed to provide reasonable protection against harmful interference in a residential installation. This equipment generates uses and can radiate radio frequency energy and, if not installed and used in accordance with the instructions, may cause harmful interference to radio communications. However, there is no guarantee that interference will not occur in a particular installation. If this equipment does cause harmful interference to radio or television reception, which can be determined by turning the equipment off and on, the user is encouraged to try to correct the interference by one or more of the following measures:

- Increase the separation between the equipment and receiver.
- Connect the equipment into an outlet on a circuit different from that to which the receiver is connected.
- Consult the dealer or an experienced marine electronics technician for help.

CAUTION

This device is intended for general population use to satisfy FCC RX exposure compliance. See section “**1.2 SAFETY INFORMATION**” for specific operating requirement.

This device complies with part 15 of the FCC rules. Operation is subject to the condition that this device does not cause harmful interference.

Part 15.21: Changes or modifications to this device not expressly approved by YAESU MUSEN could void the User’s authorization to operate this device.

STANDARD HORIZON

Nothing takes to water like Standard Horizon

STANDARD HORIZON

YAESU USA

6125 Phyllis Drive, Cypress, California 90630

Copyright 2012
YAESU MUSEN CO., LTD.
All rights reserved.

No portion of this manual
may be reproduced
without the permission of
YAESU MUSEN CO., LTD.

Printed in China

