

STANDARD HORIZON

MATRIX SERIES GX2000 and GX2100

25 Watt VHF/FM
Marine Transceivers

Owner's Manual

- Integrated dual channel AIS (Automatic Identification System) receiver (GX2100)
 - AIS (Automatic Identification System) receiver or transponder connection (GX2000)
 - AIS target display: MMSI, Call Sign, Ship Name, BRG, DST, SOG, and COG*
 - Contact AIS Ship with DSC*
 - 38400 AIS VDM sentence output to compatible GPS Chart Plotter (GX2100)
 - 80 dB Commercial grade receiver
 - Class D DSC (Digital Selective Calling) with Individual, All Ship, Position Report, Position Request, and Distress.
 - Automatically poll up to 4 ships
 - Independent Channel 70 receiver built-in for continuous DSC watch
 - Local/Distance attenuator
 - Enter, Save, and Navigation to waypoint with Compass page*
 - Navigation to a DSC Distress Call*
 - Submersible JIS-7 / IPX7 (3.3 feet for 30 minutes)
 - ClearVoice noise canceling speaker microphone with channel selection and 16/9 key
 - Oversized rotary channel knob with push to enter, backlit display and keys
 - 30 Watt PA/Loud Hailer with pre-programmed fog signals and (listen back GX2100)
 - Capable of connecting an optional RAM3 second station remote microphone
 - Intercom between radio and RAM3
 - DSC position request and report function when connected to compatible GPS chart plotter
 - Voice Scrambler (optional)
 - One button access to Channel 16 and 9
 - User programmable soft keys
 - Navigation (LAT/LON, SOG, and COG) information shown on display*
 - E2O (Easy-To-Operate) menu system
- ※ When connected to an optional GPS (GX2100)
When connected to an optional GPS and AIS receiver or transponder (GX2000)



MATRIX AIS GX2100



MATRIX GX2000

TABLE OF CONTENTS

Quick Reference Guide	4, 5
1 GENERAL INFORMATION	8
2 PACKING LIST	9
3 OPTIONS	9
4 SAFETY/WARNING INFORMATION	10
5 FCC RADIO LICENSE INFORMATION	11
6 FCC NOTICE	12
7 GETTING STARTED	13
7.1 ABOUT VHF RADIO	13
7.2 SELECTING AN ANTENNA	13
7.3 COAXIAL CABLE	14
7.4 EMERGENCY (CHANNEL 16 USE)	15
7.5 CALLING ANOTHER VESSEL (CHANNEL 16 OR 9)	16
7.5 MAKING TELEPHONE CALLS	17
7.7 OPERATING ON CHANNELS 13 AND 67	17
8 INSTALLATION	18
8.1 LOCATION	18
8.2 MOUNTING THE RADIO	18
8.3 ELECTRICAL CONNECTIONS	20
8.4 ACCESSORY CABLE	21
8.5 CHECKING GPS CONNECTIONS	23
8.6 CHANGING THE GPS TIME	24
8.7 CHANGING THE TIME LOCATION	24
8.8 CHANGING THE TIME FORMAT	24
8.9 CHANGING COG TO TRUE OR MAGNETIC	25
8.10 OPTIONAL CMP30 (RAM3) INSTALLATION	26
9 CONTROLS AND INDICATORS	28
9.1 CONTROLS AND CONNECTIONS	28
10 BASIC OPERATION	33
10.1 PROHIBITED COMMUNICATIONS	33
10.2 RECEPTION	33
10.3 TRANSMISSION	33
10.4 TRANSMIT TIME-OUT TIMER (TOT)	34
10.5 SIMPLEX/DUPLEX CHANNEL USE	34
10.6 DISPLAY TYPE	34
10.7 USA, CANADA, AND INTERNATIONAL MODE	35
10.8 NOAA WEATHER CHANNELS	35
10.9 DUAL WATCH (TO CH16)	36
10.10 SCANNING	37
10.11 PRESET CHANNELS (0 ~ 9): INSTANT ACCESS	39
10.12 PA/FOG Operation	40
10.13 INTERCOM OPERATION	43
10.14 VOICE SCRAMBLER	44
11 DIGITAL SELECTIVE CALLING	46
11.1 GENERAL	46
11.2 MARITIME MOBILE SERVICE IDENTITY (MMSI)	46
11.2.1 What is an MMSI?	46
11.2.2 Programming the MMSI	47
11.3 DSC DISTRESS CALL	48
11.3.1 Transmitting a DSC Distress Call	48
11.3.2 Receiving a DSC Distress Call	51
11.4 ALL SHIPS CALL	52
11.4.1 Transmitting an All Ships Call	52
11.4.2 Receiving an All Ships Call	53
11.5 INDIVIDUAL CALL	54
11.5.1 Setting up the Individual / Position Call Directory	54
11.5.2 Setting up Individual Reply	55
11.5.3 Setting up Individual / Group Call Ringer	55
11.5.4 Transmitting an Individual Call	56
11.5.5 Receiving an Individual Call	58
11.6 CALL WAITING DIRECTORY	59
11.6.1 Enabling the Call Waiting Feature	59
11.6.2 Reviewing Received Calls Logged into the Call Waiting Directory	59
11.6.3 Deleting a call from the "DSC LOG" directory	60
11.7 GROUP CALL	61
11.7.1 Setup a Group Call	61

TABLE OF CONTENTS

	11.7.2	Transmitting a Group Call	63
	11.7.3	Receiving a Group Call	64
11.8		POSITION REQUEST	65
	11.8.1	Setting up Position Reply	65
	11.8.2	Transmitting a Position Request to Another Vessel	66
	11.8.3	Receiving a Position Request	67
11.9		POSITION REPORT	68
	11.9.1	Transmitting a DSC Position Report Ringer	68
	11.9.2	Transmitting a DSC Position Report Call	68
	11.9.3	Receiving a DSC Position Report Call	70
11.10		MANUAL INPUTTING OF A GPS LOCATION (LAT/LON)	71
11.11		AUTO DSC POLLING	72
	11.11.1	Selecting Stations to be Automatically Polled (tracked)	72
	11.12.2	Enable/Disable Auto DSC Polling	73
12		RADIO SETUP MODE	74
	12.1	DISPLAY	74
	12.2	LOCAL DISTANCE ATTENUATOR	75
	12.3	LAMP ADJUSTING	75
	12.4	Display CONTRAST	76
	12.5	TIME OFFSET	77
	12.6	TIME AREA	78
	12.7	TIME DISPLAY	78
	12.8	UNIT OF MEASURE	79
	12.9	MAGNETIC	80
	12.10	KEY BEEP	80
	12.11	FOG ALERT TONE FREQUENCY	81
	12.12	SOFT KEY	82
	12.13	CH GROUP	83
	12.14	SCAN MEMORY	83
	12.15	SCAN TYPE	84
	12.16	SCAN RESUME	84
	12.17	PRIORITY CHANNEL	85
	12.18	WEATHER ALERT	85
	12.19	CHANNEL NAME	86
	12.20	STATION NAME	87
	12.21	SCRAMBLER	88
13		AIS / COMPASS SETUP	89
	13.1	AUTOMATIC IDENTIFICATION SYSTEM (AIS)	89
	13.2	DIRECTION	90
	13.3	ACTIVATION RANGE	90
	13.3	CPA ALARM	91
	13.4	TCPA ALARM	91
	13.5	DISPLAY RANGE	92
14		WAYPOINTS	93
	14.1	STORING WAYPOINTS	93
	14.2	EDITING A WAYPOINT	94
	14.3	DELETENG A WAYPOINT	94
	14.4	SAVING A DSC POSITION CALL AS A WAYPOINT	95
	14.5	NAVIGATING TO A SAVED WAYPOINT	95
	14.6	STOP NAVIGATING TO A WAYPOINT	96
15		AIS OPERATION	97
	15.1	AIS RANGE	98
16		ENHANCED RAM+ MIC OPERATION	99
	16.1	RAM+ MIC CONTROLS	99
17		MAINTENANCE	102
	17.1	REPLACEMENT PARTS	102
	17.2	FACTORY SERVICE	102
	17.3	TROUBLESHOOTING CHART	103
18		CHANNEL ASSIGNMENTS	104
19		WARRANTY	110
20		RESET PROCEDURES	113
21		SPECIFICATIONS	114

QUICK REFERENCE GUIDE

① [PWR/VOL] KNOB

Press and hold this knob until the LCD turns on, and adjust the audio level.

② [CH] KNOB

Selects the operating channel.

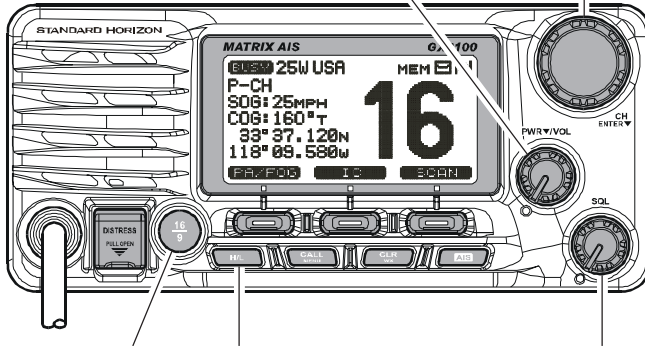

⑤ [16/9] BUTTON

- Press to recall channel 16.
- Press and hold to recall channel 9.

④ [H/L] BUTTON

When pressed, toggles the transmit power between High (25W) and Low (1W).

③ [SQL] KNOB

Move this control clockwise to squelch or counter clockwise un-squelch the radio.

⑥ [PTT] SWITCH

Place your mouth about 1/2 inch away from Mic hole and speak in a normal voice level while pressing this switch.

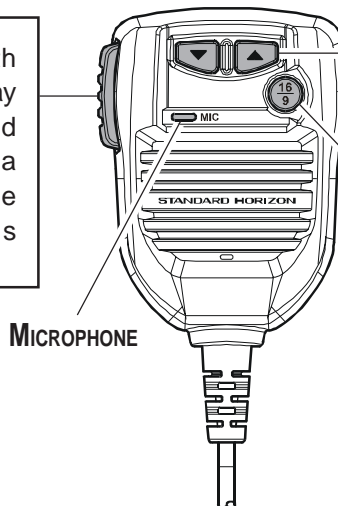

② [▼] / [▲] KEY

Selects the operating channel.

⑤ [16/9] BUTTON

- Press to recall channel 16.
- Press and hold to recall channel 9.

QUICK REFERENCE GUIDE

[DISTRESS] BUTTON

Note: for this key to operate a MMSI must be programmed.

To transmit a DSC Distress call, lift the red cover, press the Distress button once, then press and hold until the radio alarms.

[SOFT] KEY

The 3 soft keys underneath the display can be customized, refer to section “12.12 **SOFT KEY**”.

The factory defaults are Key 1: [PA/FOG], 2: [IC], and 3: [SCAN] key.

[CH] KNOB

- Select a Marine VHF or NOAA Weather channel.
- Select the item in the “SETUP MENU” and “DSC MENU”.
- When the “SETUP MENU” or “DSC MENU” is selected, pressing this knob saves a selection.

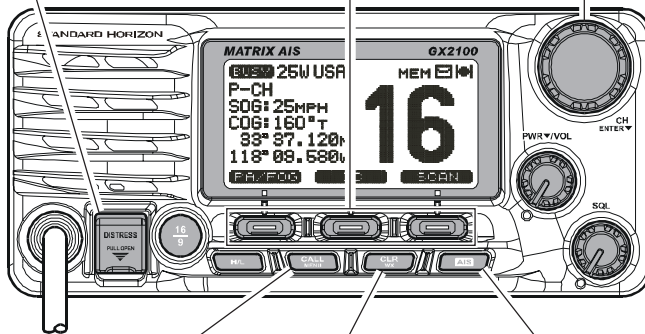

[CALL/MENU] BUTTON

- Press to access the “DSC MENU”, refer to section “11 **DIGITAL SELECTIVE CALLING**”.
- Press and hold to access the “SETUP MENU”, refer to section “12 **RADIO SETUP MODE**”.

[CLR/WX] BUTTON

- Press to cancel a menu selection.
- Press and hold to recall the last-used NOAA Weather Channel.

[AIS] BUTTON

Press to change the display to AIS (Automatic Identification System) mode. To setup AIS features, refer to section “13 **AIS / COMPASS SETUP**”.

ELECTRICAL CONNECTIONS

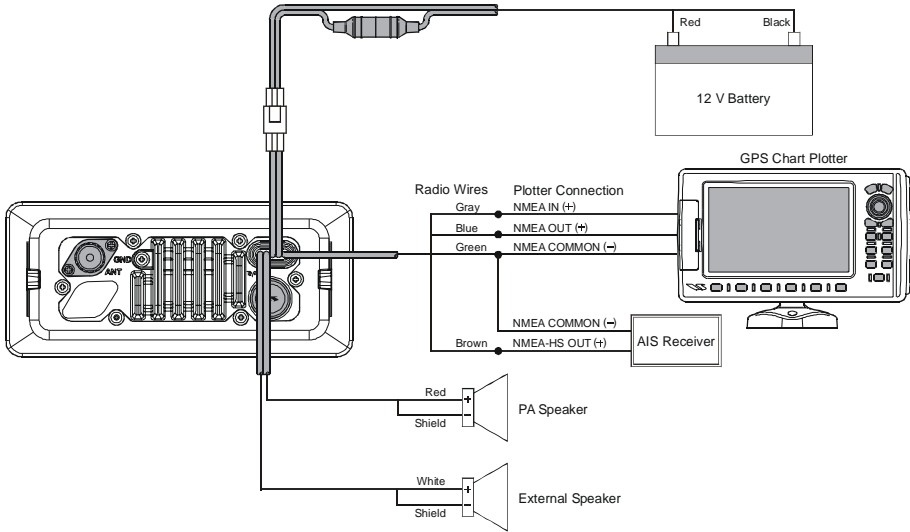

MATRIX GX2000

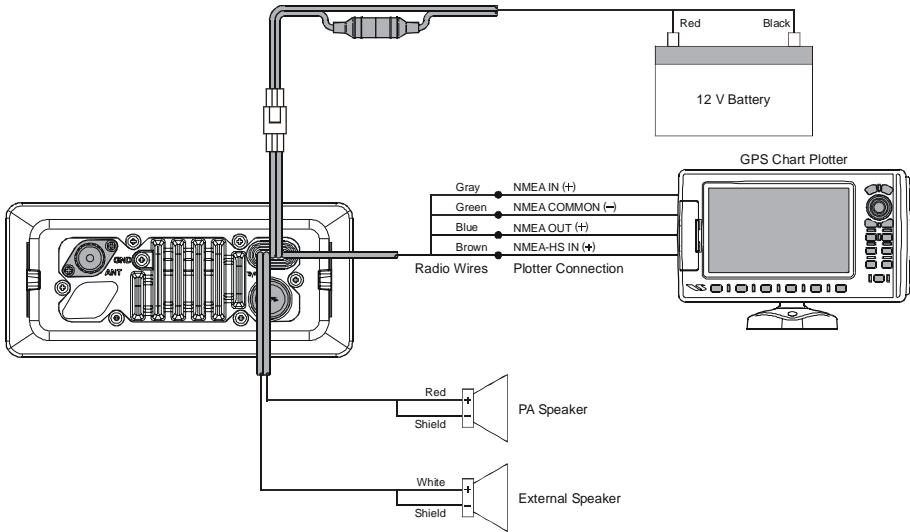

MATRIX AIS GX2100

DESKTOP/OVERHEAD MOUNTING THE RADIO

The supplied universal mounting bracket allows desktop or overhead mounting.

Use a 13/64" (5.2-mm) bit to drill the holes to a surface which is more 0.4 inch (10 mm) thick and can support more than 3.3 lbs (1.5 kg) and secure the bracket with the supplied screws, spring washers, flat washers, and nuts.

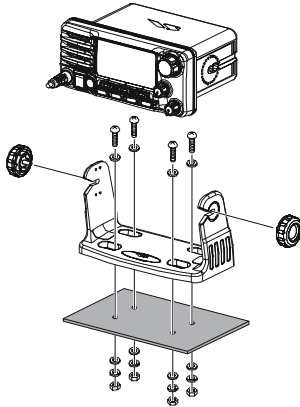

DESKTOP MOUNTING

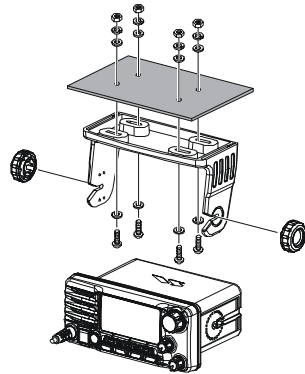

OVERHEAD MOUNTING

FLUSH MOUNTING THE RADIO

The optional **MMB-84** Flush-Mount Bracket allows flush mounting the radio to your vessel.

1. Use the supplied template to mark the location where the rectangular hole is to be cut. Confirm the space behind the dash or panel is deep enough to accommodate the transceiver (at least 6.7 inches or 17 cm deep).

There should be at least 1/2 inch (1.3 cm) between the transceiver's heatsink and any wiring, cables or structures.

2. Cut out the rectangular hole and insert the transceiver.
3. Fasten the optional **MMB-84** brackets to the sides of the transceiver with the lock washer nut combination; so that the mounting screw base faces the mounting surface.
4. Turn the adjusting screw to adjust the tension so that the transceiver is tight against the mounting surface.

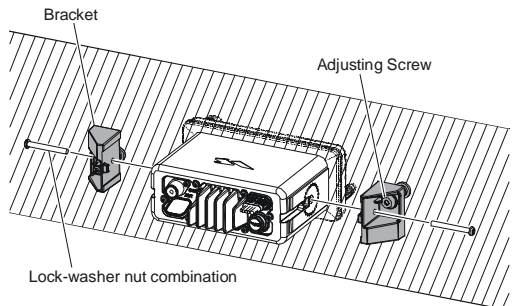

1 GENERAL INFORMATION

1.1 INTRODUCTION

The STANDARD HORIZON MATRIX Series **GX2000** and **GX2100** Marine VHF/FM Marine transceiver are designed to be used in USA, International and Canadian Marine bands. The **GX2000** and **GX2100** can be operated from 11 to 16 VDC and has a switchable RF output power of 1 watt or 25 watts.

MATRIX AIS GX2100

Integrates a dual channel AIS (Automatic Identification System) receiver to display AIS vessel information (MMSI, Call Sign, Ship Name, BRG, DST, SOG and COG) directly on the VHF radio, so you will know what is out there in any conditions. The **GX2100** is also capable of entering and saving up to 100 waypoints, which may be selected and navigated to by using a unique navigation compass display. The MATRIX AIS allows you to contact an AIS Ship directly using DSC, show your vessels position in relation to AIS targets and alert you when an AIS ship may be approaching too close to your location via the Closest Point of Approach (CPA) Alarm. To receive AIS targets from ships with AIS class A or B transponders. Simply connect the normal VHF antenna (only one antenna needed!)

MATRIX - GX2000

For the mariner who already has AIS on-board and desires a VHF with the features of the MATRIX AIS, the MATRIX **GX2000** has a connection for an AIS receiver or transponder.

The MATRIX Series VHF's are capable of DSC (Digital Selective Calling) Class D operation. Class D operation allows continuous receiving of Digital Selective Calling functions on channel 70 even if the radio is receiving a call. The MATRIX Series VHF's operate on all currently-allocated marine channels which are switchable for use with USA, International, or Canadian regulations. Emergency channel 16 can be immediately selected from any channel by pressing the red [16/9] key. NOAA Weather channels can also be accessed immediately by pressing and holding the [CLR(WX)] key.

Other features of the MATRIX Series VHF's include: Speaker Microphone, 30W PA/Fog, optional RAM3 second station remote-control microphone with display, multi-station intercom with **RAM3**, scanning, priority scanning, submersible speaker mic, high and low voltage warning, and GPS repeatability.

2 PACKING LIST

When the package containing the transceiver is first opened, please check it for the following contents:

- **GX2000** or **GX2100** Transceiver
- Mounting Bracket and hardware
- Owner’s Manual
- Warning Sticker
- Flush Mount Template
- Power Cord

3 OPTIONS

MMB-84	Flush-Mount Bracket
CMP30B/W	Remote-Access Microphone (RAM+ Mic, Black/White)
CT-100	23-foot Extension Cable for RAM3 Mic
CVS2500	Voice Scrambler
MLS-310	10W amplified External Speaker with on/off Volume control
MLS-300	External Loud Speaker
220SW	4.5” Round Hail/PA Horn
240SW	5” x 8” Rectangular Hail/PA Horn

4 SAFETY / WARNING INFORMATION

This radio is restricted to occupational use, work related operations only where the radio operator must have the knowledge to control the exposure conditions of its passengers and bystanders by maintaining the minimum separation distance of 0.89 m (2.92 feet). Failure to observe these restrictions will result in exceeding the FCC RF exposure limits.

Antenna Installation:

The antenna must be located at least 0.89 m (2.92 feet) away from passengers in order to comply with the FCC RF exposure requirements.

ON-LINE WARRANTY REGISTRATION (in USA or Canada only)

Please visit www.standardhorizon.com to register the **GX2000/GX2100** Marine VHF. It should be noted that visiting the Web site from time to time may be beneficial to you, as new products are released they will appear on the STANDARD HORIZON Web site.

PRODUCT SUPPORT INQUIRIES

If you have any questions or comments regarding the use of the **GX2000/GX2100**, you can visit the STANDARD HORIZON Web site to send an E-Mail or contact the Product Support team at (800) 767-2450 M-F 7:00-5:00PST.

5 FCC RADIO LICENSE INFORMATION

Standard Horizon radios comply with the Federal Communication Commission (FCC) requirements that regulate the Maritime Radio Service.

5.1 STATION LICENSE

An FCC ship station license is no longer required for any vessel traveling in U.S. waters (except Hawaii) which is under 20 meters in length. However, any vessel required to carry a marine radio on an international voyage, carrying a HF single side band radiotelephone or marine satellite terminal is required to have a ship station license. FCC license forms, including applications for ship (605) and land station licenses can be downloaded via the Internet at <http://www.fcc.gov/Forms/Form605/605.html>. To obtain a form from the FCC, call (888) 225-5322.

5.2 RADIO CALL SIGN

Currently the FCC does not require recreational boaters to have a Ship Radio Station License. The USCG recommends the boats registration number and the state to be used when calling another vessel.

5.3 CANADIAN SHIP STATION LICENSING

You may need a license when traveling in Canada. If you do need a license contact their nearest field office or regional office or write:

**Industry Canada
Radio Regulatory Branch
Attn: DOSP
300 Slater Street
Ottawa, Ontario
Canada, KIA 0C8**

5.4 FCC / INDUSTRY CANADA INFORMATION

The following data pertaining to the transceiver is necessary to fill out the license application.

Type Acceptance FCC Part 80
Output Power 1 Watt (low) and 25 Watts (high)
Emission 16K0G3E, 16K0G2B
Frequency Range 156.025 to 163.275 MHz
FCC Type Number K6630443X3D
Industry Canada Type Approval 511B-30443X3S

6 FCC NOTICE

NOTICE

Unauthorized changes or modifications to this equipment may void compliance with FCC Rules. Any change or modification must be approved in writing by STANDARD HORIZON.

NOTICE

This equipment has been tested and found to comply with the limits for a Class B digital device, pursuant to Part 15 of the FCC Rules. These limits are designed to provide reasonable protection against harmful interference in a residential installation. This equipment generates, uses and can radiate radio frequency energy and, if not installed and used in accordance with the instructions, may cause harmful interference to radio communications. However, there is no guarantee that interference will not occur in a particular installation. If this equipment does cause harmful interference to radio or television reception, which can be determined by turning the equipment off and on, the user is encouraged to try to correct the interference by one or more of the following measures:

- Reorient or relocate the receiving antenna.
- Increase the separation between the equipment and receiver.
- Connect the equipment into an outlet on a circuit different from that to which the receiver is connected.
- Consult the dealer or an experienced radio/TV technician for help.

7 GETTING STARTED

7.1 ABOUT VHF RADIO

The radio frequencies used in the VHF marine band lie between 156 and 158 MHz with some shore stations available between 161 and 163 MHz. The marine VHF band provides communications over distances that are essentially “line of sight” (VHF signals do not travel well through objects such as buildings, hills or trees). Actual transmission range depends much more on antenna type, gain and height than on the power output of the transmitter. On a fixed mount 25W radio transmission expected distances can be greater than 15 miles, for a portable 5W radio transmission the expected distance can be greater than 5 miles in “line of sight”.

7.2 SELECTING AN ANTENNA

Marine antennas are made to radiate signals equally in all horizontal directions, but not straight up. The objective of a marine antenna is to enhance the signal toward the horizon. The degree to which this is accomplished is called the antenna’s gain. It is measured in decibels (dB) and is one of the major factors in choosing an antenna. In terms of effective radiated power (ERP), antennas are rated on the basis of how much gain they have over a theoretical antenna with zero gain. A 3 foot, 3dB gain antenna represents twice as much gain over the imaginary antenna.

Typically a 3 foot 3dB gain stainless steel whip is used on a sailboat mast. The longer 8 foot 6dB fiberglass whip is primarily used on power boats that require the additional gain.

7.3 COAXIAL CABLE

VHF antennas are connected to the transceiver by means of a coaxial cable – a shielded transmission line. Coaxial cable is specified by its diameter and construction.

For runs less than 20 feet, RG-58/U, about 1/4 inch in diameter is a good choice. For runs over 20 feet but less than 50 feet, the larger RG-8X or RG-213/U should be used for cable runs over 50 feet RG-8X should be used. For installation of the connector onto the coaxial cable refer to the figure below.

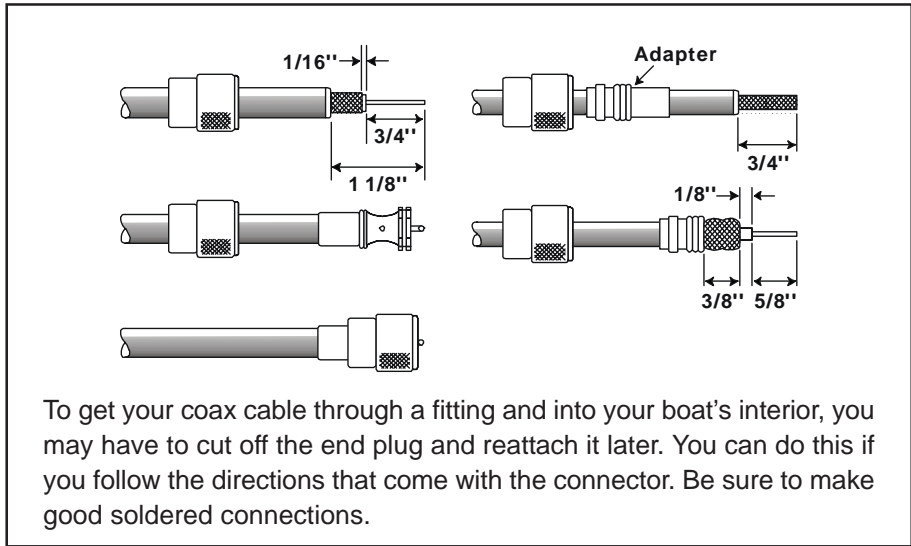

7.4 EMERGENCY (CHANNEL 16 USE)

Channel 16 is known as the Hail and Distress Channel. An emergency may be defined as a threat to life or property. In such instances, be sure the transceiver is on and set to CHANNEL 16. Then use the following procedure:

1. Press the microphone push-to-talk switch and say “**Mayday, Mayday, Mayday**. This is _____, _____, _____” (your vessel’s name).
2. Then repeat once: “**Mayday, _____**” (your vessel’s name).
3. Now report your position in latitude/longitude, or by giving a true or magnetic bearing (state which) to a well-known landmark such as a navigation aid or geographic feature such as an island or harbor entry.
4. Explain the nature of your distress (sinking, collision, aground, fire, heart attack, life-threatening injury, etc.).
5. State the kind of assistance your desire (pumps, medical aid, etc.).
6. Report the number of persons aboard and condition of any injured.
7. Estimate the present seaworthiness and condition of your vessel.
8. Give your vessel’s description: length, design (power or sail), color and other distinguishing marks. The total transmission should not exceed 1 minute.
9. End the message by saying “**OVER**”. Release the microphone button and listen.
10. If there is no answer, repeat the above procedure. If there is still no response, try another channel.

NOTE

The **GX2000** and **GX2100** have DSC Distress calling, that can transmit a distress call digitally to all ships with compatible DSC radios. Refer to section “**11 DIGITAL SELECTIVE CALL**”.

7.5 CALLING ANOTHER VESSEL (CHANNEL 16 OR 9)

Channel 16 may be used for initial contact (hailing) with another vessel. However, its most important use is for emergency messages. This channel must be monitored at all times except when actually using another channel. It is monitored by the U.S. and Canadian Coast Guards and by other vessels. **Use of channel 16 for hailing must be limited to initial contact only.** Calling should not exceed 30 seconds, but may be repeated 3 times at 2-minute intervals. In areas of heavy radio traffic, congestion on channel 16 resulting from its use as a hailing channel can be reduced significantly in U.S. waters by using **channel 9** as the initial contact (hailing) channel for non-emergency communications. Here, also, calling time should not exceed 30 seconds but may be repeated 3 times at 2-minute intervals.

Prior to making contact with another vessel, refer to the channel charts in this manual, and select an appropriate channel for communications after initial contact. For example, Channels 68 and 69 of the U.S. VHF Charts are some of the channels available to non-commercial (recreational) boaters. Monitor your desired channel in advance to make sure you will not be interrupting other traffic, and then go back to either channel 16 or 9 for your initial contact.

When the hailing channel (16 or 9) is clear, state the name of the other vessel you wish to call and then **“this is”** followed by the name of your vessel and your Station License (Call Sign). When the other vessel returns your call, immediately request another channel by saying **“go to,”** the number of the other channel, and **“over.”** Then switch to the new channel. When the new channel is not busy, call the other vessel.

After a transmission, say **“over,”** and release the microphone’s push-to-talk (PTT) switch. When all communication with the other vessel is completed, end the last transmission by stating your Call Sign and the word **“out.”** Note that it is not necessary to state your Call Sign with each transmission, only at the beginning and end of the contact.

Remember to return to Channel 16 when not using another channel. Some radios automatically monitor Channel 16 even when set to other channels or when scanning.

7.6 MAKING TELEPHONE CALLS

To make a radiotelephone call, use a channel designated for this purpose. The fastest way to learn which channels are used for radiotelephone traffic is to ask at a local marina. Channels available for such traffic are designated **Public Correspondence** channels on the channel charts in this manual. Some examples for USA use are Channels 24, 25, 26, 27, 28, 84, 85, 86, and 87. Call the marine operator and identify yourself by your vessel's name. The marine operator will then ask you how you will pay for the call (telephone credit card, collect, etc.) and then link your radio transmission to the telephone lines.

The marine telephone company managing the VHF channel you are using may charge a link-up fee in addition to the cost of the call.

7.7 OPERATING ON CHANNELS 13 AND 67

Channel 13 is used at docks and bridges and by vessels maneuvering in port. Messages on this channel must concern navigation only, such as meeting and passing in restricted waters.

Channel 67 is used for navigational traffic between vessels.

By regulation, power is normally limited to 1 Watt on these channels. Your radio is programmed to automatically reduce power to this limit on these channels. However, in certain situations it may be necessary to temporarily use a higher power. See page 23 (H/L key) for means to temporarily override the low-power limit on these two channels.

8 INSTALLATION

8.1 LOCATION

The radio can be mounted at any angle. Choose a mounting location that:

- is far enough from any compass to avoid any deviation in compass reading due to the speaker magnet
- provides accessibility to the front panel controls
- allows connection to a power source and an antenna
- has nearby space for installation of a microphone hanger
- the antenna must be mounted at least 3 feet from radio
- choose a mounting location that is at least 3 feet away from the radio's antenna.

Note: To insure the radio does not affect the compass or radios performance is not affected by the antenna location, temporarily connect the radio in the desired location and:

- a. Examine the compass to see if the radio causes any deviation
- b. Connect the antenna and key the radio. Check to ensure the radio is operating correctly by requesting a radio check.

8.2 MOUNTING THE RADIO

8.2.1 Supplied Mounting Bracket

The supplied mounting bracket allows overhead or desktop mounting.

Use a 13/64" (5.2-mm) bit to drill the holes to a surface which is more 0.4 inch (10 mm) thick and can support more than 3.3 lbs (1.5 kg) and secure the bracket with the supplied screws, spring washers, flat washers, and nuts.

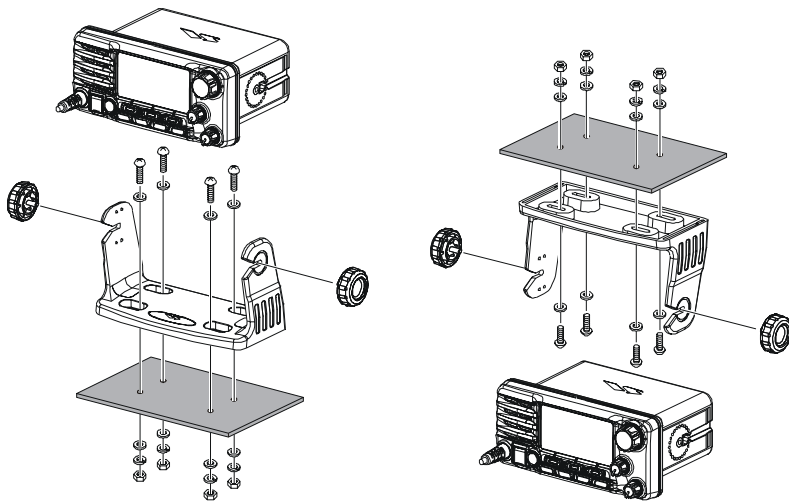

DESKTOP MOUNTING

OVERHEAD MOUNTING

8.2.2 Optional MMB-84 Flush Mount Bracket

1. Make a rectangular template for the flush mount measuring 2.6" H x 6.3" W (65 x 161 mm).
2. Use the template to mark the location where the rectangular hole is to be cut. Confirm the space behind the dash or panel is deep enough to accommodate the transceiver (at least 6 inches deep). There should be at least 1/2 inch between the transceiver's heatsink and any wiring, cables or structures.
3. Cut out the rectangular hole and insert the transceiver.
4. Fasten the brackets to the sides of the transceiver with the lock washer nut combination; so that the mounting screw base faces the mounting surface (see illustration below).
5. Turn the adjusting screw to adjust the tension so that the transceiver is tight against the mounting surface.

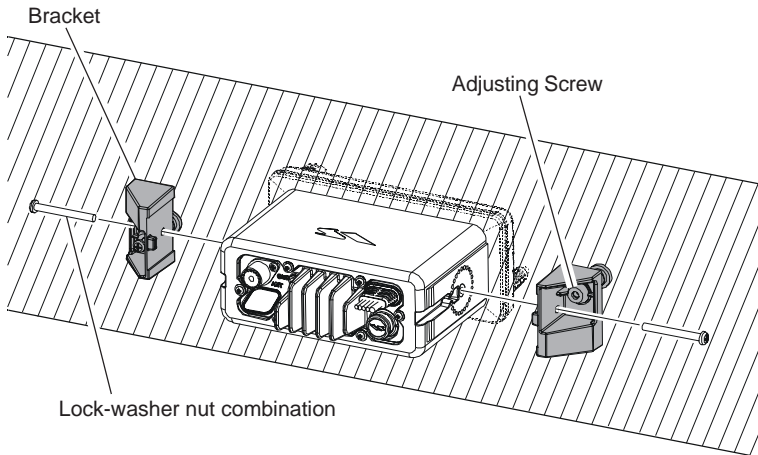

8.3 ELECTRICAL CONNECTIONS

CAUTION

Reverse polarity connections will damage the radio!

Connect the power cord and antenna to the radio. Antenna and Power Supply connections are as follows:

1. Mount the antenna at least 3 feet away from the radio. At the rear of the radio, connect the antenna cable. The antenna cable must have a PL259 connector attached. RG-8/U coaxial cable must be used if the antenna is 25 feet or more from the radio. RG58 cable can be used for distances less than 25 feet.
2. Connect the red power wire to a 13.8 VDC $\pm 20\%$ power source. Connect the black power wire to a negative ground.
3. If an optional remote extension speaker is to be used, refer to section 3.3 for connections.
4. It is advisable to have a Certified Marine Technician check the power output and the standing wave ratio of the antenna after installation.

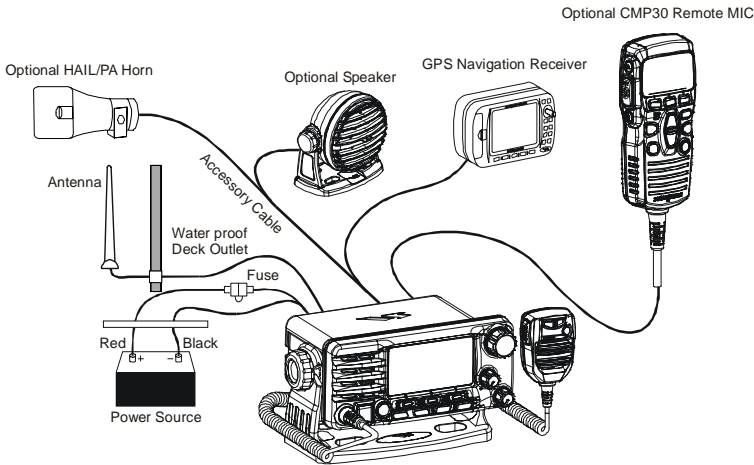

Fuse Replacement

To take out the Fuse from the Fuse Holder, hold both ends of the Fuse Holder and pull the Fuse Holder apart without bending the fuse Holder. When you replace the Fuse, please confirm that the Fuse is tightly fixed on the metal contact located inside the Fuse Holder. If the metal contact holding the fuse is loose, the Fuse holder may heat up.

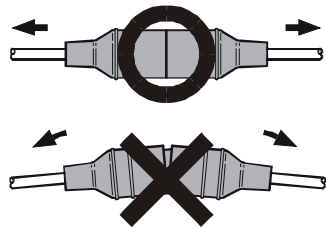

8.4 ACCESSORY CABLE

8.4.1 MATRIX GX2000 Connection

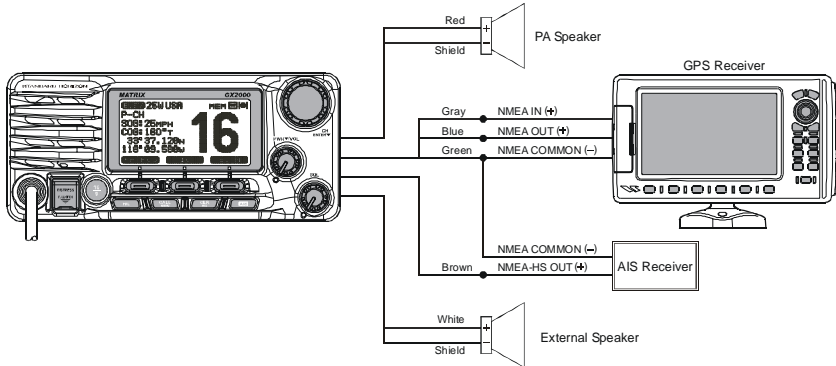

Wire Color/Description	Connection Examples
WHITE - External Speaker (+)	Connect to external 4 Ohm audio speaker
SHIELD - External Speaker (-)	Connect to external 4 Ohm audio speaker
RED - PA Speaker (+)	Connect to external 4 Ohm PA speaker
SHIELD - PA Speaker (-)	Connect to external 4 Ohm PA speaker
GREEN - NMEA Ground	Connect to NMEA (-) connection of GPS
BLUE - NMEA Input (+)	Connect to NMEA (+) output of GPS
GRAY - NMEA Output (+)	Connect to NMEA (+) input of GPS
BROWN - AIS INPUT (+)	Connect to NMEA 34.8K baud (+) output of AIS receiver

8.4.2 MATRIX AIS GX2100 Connection

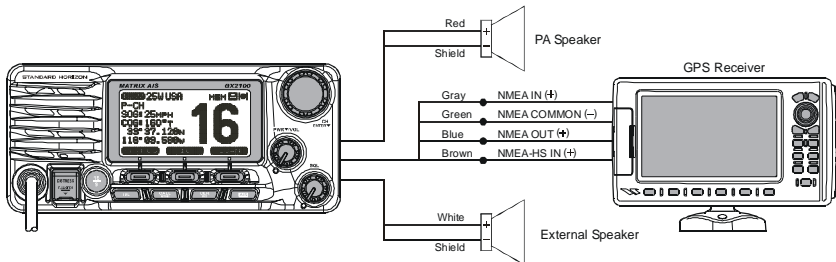

Wire Color/Description	Connection Examples
WHITE - External Speaker (+)	Connect to external 4 Ohm audio speaker
SHIELD - External Speaker (-)	Connect to external 4 Ohm audio speaker
RED - PA Speaker (+)	Connect to external 4 Ohm PA speaker
SHIELD - PA Speaker (-)	Connect to external 4 Ohm PA speaker
GREEN - NMEA Ground	Connect to NMEA (-) connection of GPS
BLUE - NMEA Input (+)	Connect to NMEA (+) output of GPS
GRAY - NMEA Output (+)	Connect to NMEA (+) input of GPS
BROWN - AIS Data Output (+)	Connect to NMEA 34.8K baud (+) input of GPS

When connecting the external speaker or GPS navigation receiver, strip off about 1 inch (2.5 cm) of the specified wire's insulation, then splice the ends together.

Note: In some areas powerful AM broadcast stations may be heard when in listen-back mode. In this case change the speaker wire to 2-conductor shielded audio cable. See the illustration below for connections.

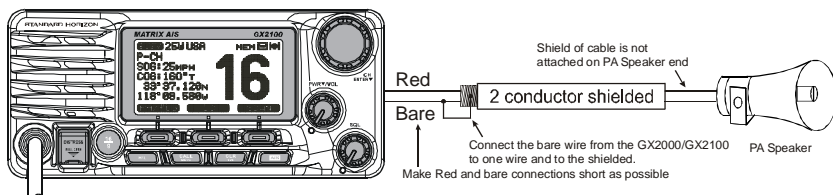

GPS Connection

- The GPS must have the NMEA Output turned on and set to 4800 Baud in the setup menu. If there is a selection for parity select none.
- For further information on interfacing /setting up your GPS. Please contact the manufacturer of the GPS receiver.
- **GX2000/GX2100** can read NMEA-0183 version 2.0 or higher.
- The NMEA supported sentences are:
Input: GLL, GGA, RMC and GNS (RMC sentence is recommended)
Output: DSC and DSE
(DSC sentences to Standard Horizon Plotter for Position Polling)

AIS Connections

The MATRIX **GX2000** (without internal AIS receiver) may be connected to an external AIS receiver or transponder that outputs NMEA VDM sentence at 38400 baud.

Wire Color/Description	Connection
BROWN - AIS Input (+)	AIS Output
GREEN - NMEA common	AIS common data wire or NMEA signal ground

The MATRIX AIS **GX2100** with internal dual channel AIS receiver has the capability to output received Class A and B targets using VDM sentence at a baud rate of 38400.

Wire Color/Description	Connection
BROWN - AIS Output (+)	GPS Chart plotter input
GREEN - NMEA common	GPS common data wire or NMEA signal ground

If you have further inquires, please feel free to contact Product Support at:
Phone: (800) 767-2450
Email: marinetech@vxstdusa.com

8.5 CHECKING GPS CONNECTIONS

After connections have been made between the **GX2000/GX2100** and the GPS, a small satellite icon will appear on the top right corner of the display and displays your current location (Latitude/Longitude) is shown on the display.

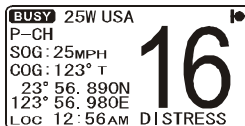

NOTE

If there is a problem with the NMEA input from a GPS, the GPS icon will blink continuously until the connection is corrected.

8.6 CHANGING THE GPS TIME

From the Factory the **GX2000/GX2100** shows GPS satellite time or UTC time when an optional GPS is connected. A time offset is needed to show the local time in your area. The Time Offset must be changed in order for the radio to display the current time in your area. Please see the Offset Time Table at the bottom of this page.

1. Press and hold down the [**CALL(MENU)**] key until “**Setup Menu**” appears, then select “**GENERAL SETUP**” with the **CHANNEL** knob.
2. Press the [**SELECT**] soft key, then select “**TIME OFFSET**” with the **CHANNEL** knob.
3. Press the [**SELECT**] soft key, then rotate the **CHANNEL** knob to select time offset from UTC. See illustration below to find your offset time from UTC. If “**00:00**” is assigned, the time is the same as UTC (Universal Time Coordinated or GMT Greenwich Mean Time).
4. Press the [**ENT**] soft key to store the time offset.
5. Press the [**QUIT**] key several times to return to radio operation.

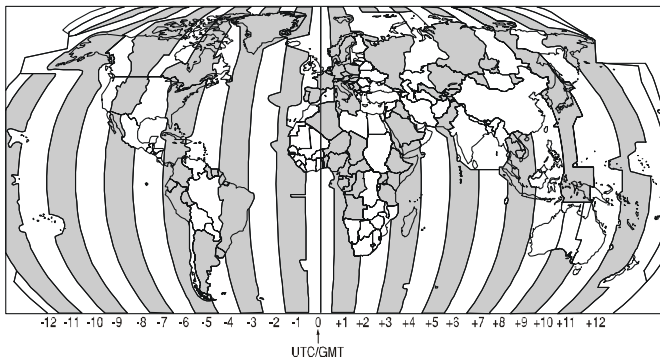
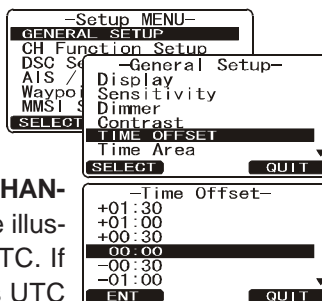

OFFSET TIME TABLE

8.7 CHANGING THE TIME LOCATION

Set the radio to show UTC time or local time with the offset inputted in section 8.6 CHANGING THE GPS TIME.

1. Press and hold down the [CALL(MENU)] key until "Setup Menu" appears, then select "GENERAL SETUP" with the CHANNEL knob.
2. Press the [SELECT] soft key, then rotate the CHANNEL knob to "TIME AREA".
3. Press the [SELECT] soft key.
4. Rotate the CHANNEL knob to select "UTC" or "LOCAL".
5. Press the [ENT] soft key to store the selected setting.
6. Press the [QUIT] key several times to return to radio operation.

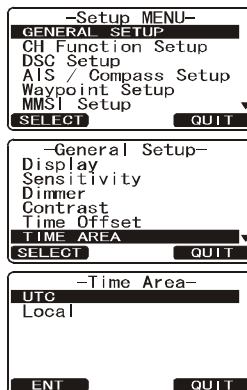

8.8 CHANGING THE TIME FORMAT

Set the radio to show 12-hour format or 24-hour format of the clock.

1. Press and hold down the [CALL(MENU)] key until "Setup Menu" appears, then select "GENERAL SETUP" with the CHANNEL knob.
2. Press the [SELECT] soft key, then rotate the CHANNEL knob to select "TIME DISPLAY".
3. Press the [SELECT] soft key.
4. Rotate the CHANNEL knob to select "12 HOUR" or "24 HOUR".
5. Press the [ENT] soft key to store the selected setting.
6. Press the [CLR(WX)] key several times to return to radio operation.

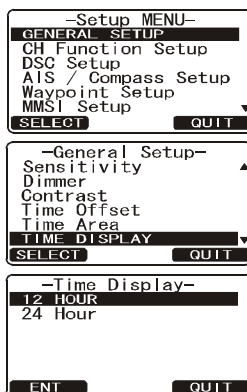

8.9 CHANGING COG TO TRUE OR MAGNETIC

Allows the GPS Course Over Ground to be selected to show in True or Magnetic. Factory default is True however by following the steps below the COG can be changed to Magnetic.

1. Press and hold down the [CALL(MENU)] key until "Seup Menu" appears, then select "GENERAL SETUP" with the CHANNEL knob.
2. Press the [SELECT] soft key, then rotate the CHANNEL knob to select "MAGNETIC".
3. Press the [SELECT] soft key.
4. Rotate the CHANNEL knob to select "MAGNETIC" or "TRUE".
5. Press the [ENT] soft key to store the selected setting.
6. Press the [QUIT] key several times to return to radio operation.

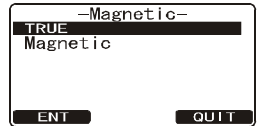
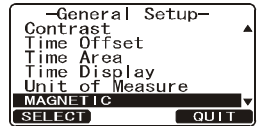

8.10 OPTIONAL CMP30 (RAM3) INSTALLATION

The **GX2000/GX2100** is capable of using a **CMP30 (RAM3)** Remote Station Microphone to remotely control the Radio, AIS, DSC and PA/Fog functions. In addition the **GX2000/GX2100** can operate as a full function intercom system.

1. Connect the Extension Cable to the Remote Mic eight pin connector on the rear panel, then tighten the Cable Nut (see illustration below).
2. Referring to illustration below, make a 1.2" (30 mm) hole in the wall, then insert the Extension Cable into this hole. Connect the Gasket and Mount Base to the Extension Cable Connector using the Nut.
3. Drill the four Screw holes (approx. 2 mm) on the wall, then install the Mounting Base to the wall using four screws.
4. Put the Rubber Cap on to the Nut. The installation is now complete.

NOTE

The routing cable can be cut and spliced, however care needs to be taken when reconnecting the wires to ensure water integrity.

Before cutting the cable make sure it is not plugged into the radio. After cutting you will notice there are the following wires:

Yellow, Green, Brown, Purple, Blue, Green, Red*, Shield*

* The red and shield wires are wrapped in foil. Remove the foil, and separate the Red and shield wires.

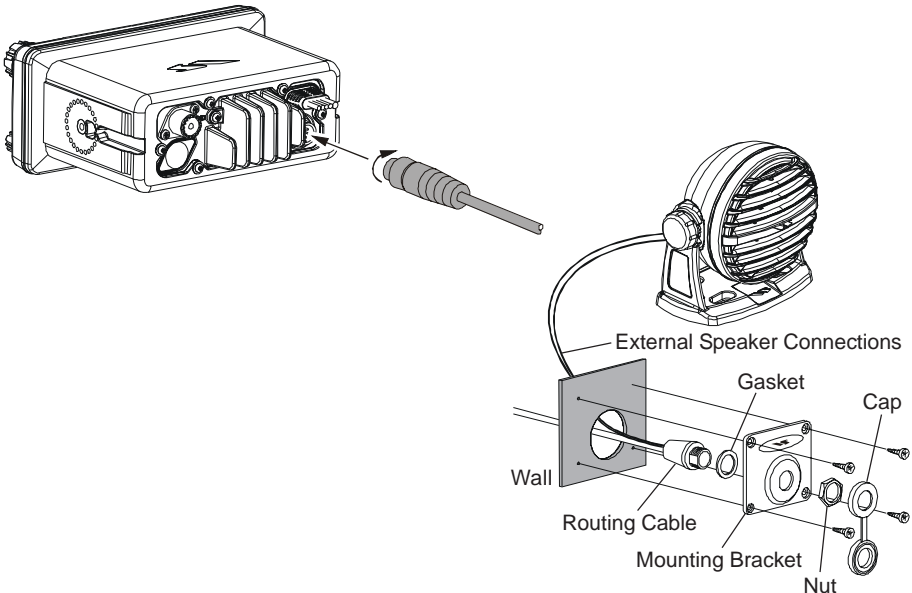

Remote Mic Speaker or External Speaker Selection

By default the **CMP30 (RAM3)** Remote Station Microphone's internal speaker is turned on. The RAM3 routing cable has two wires that may be connected to an optional external speaker to increase volume. When using an external speaker the **GX2000/GX2100** has to be setup to turn off the speaker inside the RAM3 microphone and to output speaker audio on the two wires on the routing cable to the external speaker by following the procedure below.

1. Press and hold the **[CALL(MENU)]** key until "Setup Menu" appears, then select "GENERAL SETUP" with the **[▲] / [▼]** key.
2. Press the **[ENT]** key.
3. Press the **[▼]** key to until "EXT SPEAKER" is shown and press the **[SELECT]** soft key.
4. Press the **[▲]** or **[▼]** key to select "OFF" (External speaker off) or "ON" (External speaker on).
5. Press the **[ENT]** soft key to save the selection.
6. Press the **[16/9]** key to exit this mode.

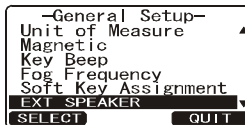
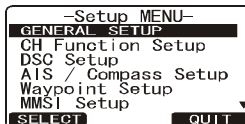

External Speaker AF Selection

The "AF Select" menu allows you to set the audio output level of the Remote Mic External Speaker to a fixed level regardless of the VOL level setting of the Remote Mic, which is useful when using the optional **MLS-310** amplified speaker with on/off volume control.

1. Press and hold the **[CALL(MENU)]** key until "Setup Menu" appears, then select "GENERAL SETUP" with the **[▲] / [▼]** key.
2. Press the **[ENT]** key.
3. Press the **[▼]** key to until "AF SELECT" is shown and press the **[SELECT]** soft key.
4. Press the **[▲]** or **[▼]** key to select "PR" (External Speaker Level is "Fixed") or "PO" (External Speaker Level is "Adjustable").
"Fixed" use when **MLS-310** is connected.
"Adjustable" use when **MLS-300** or other speaker without volume control is connected.
5. Press the **[ENT]** key to save the selection.
6. Press the **[16/9]** key to exit this mode.

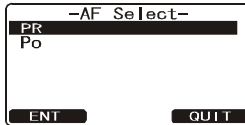
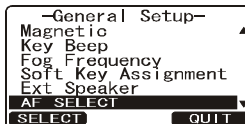
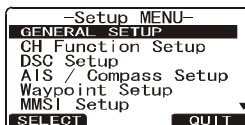

9 CONTROLS AND INDICATORS

NOTE

This section defines each control of the transceiver. See illustration at the next page for location of controls. For detailed operating instructions refer to chapter 10 of this manual.

9.1 CONTROLS AND CONNECTIONS

① CHANNEL Knob

Rotary knob used to select channels and to choose menu items (such as the DSC menu, Radio Setup and DSC Setup menu). The [**UP**(▲)] / [**DOWN**(▼)] keys on the microphone can also be used to select channels and menu items.

SECONDARY USE

- Press this knob to enter a selection in the “SETUP MENU” or “DSC MENU”.
- While holding down the [**SCAN**] key and turning this knob, you can confirm memory channels that have been programmed for scanning.
- Adjust the PA output level while in PA/FOG mode.

② PWR/VOL Knob (Power Switch / Volume Control)

Turns the transceiver on and off as well as adjusts the speaker volume. To turn the transceiver on, press and hold this knob until the radio turns on. When the power is turned on, the transceiver is set to the last selected channel. Clockwise rotation of this knob increases the internal and speaker microphone volume.

To turn the transceiver off, press and hold this knob until the radio turns off.

SECONDARY USE

When in PA or Fog mode, controls the listen back volume (**GX2100** only).

③ SQL Knob (Squelch Control)

Adjusting this control clockwise, sets the point at which random noise on the channel does not activate the audio circuits but a received signal does. This point is called the squelch threshold. Further adjustment of the squelch control will degrade reception of wanted transmissions.

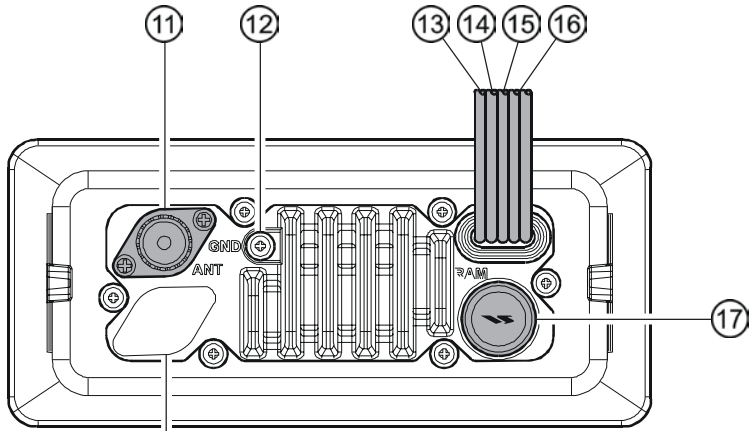
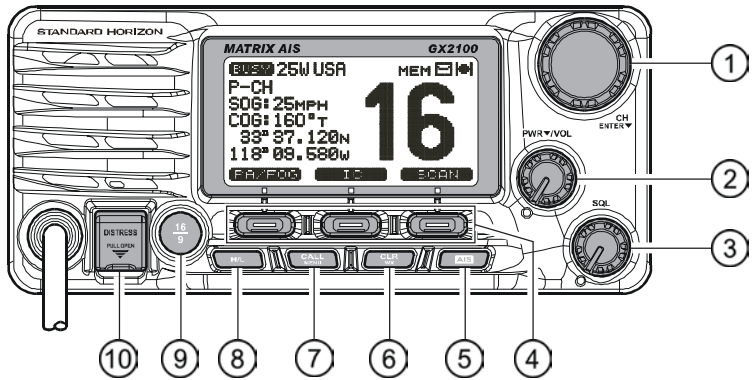

Never remove this rubber cap. When this rubber cap is removed, the water resistance performance is lost.

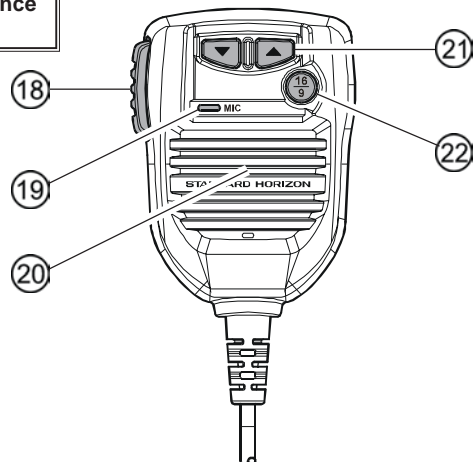

- ④ **Soft Keys**
The 3 soft keys functions can be customized by the Setup Menu mode. When one of the soft keys is pressed briefly, the functions will appear above each key on the display.
- ⑤ **[AIS] Key**
Press the **[AIS]** key to display the AIS (Automatic Identification System) targets information on the display. Refer to section “**15 AIS OPERATION**” for details.
Note: For this key to operate on the **GX2000** an optional AIS receiver or transponder must be connected.
- ⑥ **[CLR(WX)] Key**
Press the **[CLR(WX)]** key briefly to cancel a selection the “Setup Menu” and “DSC Menu”.
Press and hold the **[CLR(WX)]** key to recall the previously selected NOAA weather channel from any channel. Press and hold the **[CLR(WX)]** key again reverts to the previous selected working channel.
- ⑦ **[CALL(MENU)] Key**
Press the **[CALL(MENU)]** key to access the “DSC MENU”.
SECONDARY USE
Press and hold the **[CALL(MENU)]** key to access the “SETUP MENU”.
- ⑧ **[H/L] Key**
Press the **[H/L]** key to toggle between 25 W (High) and 1 W (Low) power. When the TX output power is set to “Low” while the transceiver is on channel 13 or 67, the output power will temporarily switch from “Low” to “High” power until the **PTT** is released. The **[H/L]** key does not function on transmit inhibited and low power only channels.
- ⑨ **[16/9] Key**
Press the **[16/9]** key briefly to recall channel 16 from any channel location. Press and hold the **[CLR(WX)]** key to recall channel 9. Pressing the **[16/9]** key again reverts to the previous selected working channel.
- ⑩ **[DISTRESS] Key**
Used to send a DSC Distress Call. To send the distress call refer to section “**11.3.1 Transmitting a DSC Distress Call.**”

- ⑪ **ANT** Jack (Antenna Jack)
Connects an antenna to the transceiver. Use a marine VHF antenna with an impedance of 50 ohms.
Note on the **GX2100** the antenna connection is used to receive marine and AIS transmissions.
- ⑫ **GND** Terminal (Ground Terminal)
Connects the **GX2000/GX2100** to a good ground, for safe and optimum performance.
Use the screw supplied with the **GX2100** and **GX2000** only.
- ⑬ Accessory Connection Cable (Green, Blue, Gray, & Brown)
Connects the **GX2000/GX2100** to a GPS receiver and AIS receiver. Refer to section “**8.4 ACCESSORY CABLE**”.
- ⑭ PA Speaker Connection Cable (Red & Shield)
Connects the **GX2000/GX2100** to an optional PA speaker. Refer to section “**3 OPTIONS**” for a list of optional STANDARD HORIZON Speakers.
- ⑮ External Speaker Connection Cable (White & Shield)
an external speaker. See section “**3 OPTIONS**” for a list of optional STANDARD HORIZON Speakers.
- ⑯ DC Input Cable
Connects the radio to a DC power supply capable of delivering 12 to 16V DC.
- ⑰ **RAM3** Connector (Remote Station Microphone Connector)
Connects the **GX2000/GX2100** to the **CMP30 (RAM3)** Remote Station Microphone. Refer to section “**16 ENHANCED RAM+ MIC OPERATION**” for details
- ⑱ **PTT** Switch (Push-To-Talk Switch)
When in radio mode, keys the transmitter for voice communications to another vessel. When the optional **RAM3** microphone is connected and the PA mode is selected, pressing the PTT switch allows your voice to be amplified and supplied to the optional PA horn, intercom mode is selected, pressing the PTT switch enables voice communications from the **GX2100** or **GX2000** to the **RAM3** second station microphone.
- ⑲ Microphone
Transmits the voice message with reduction of background noise, using Clear Voice Noise Reduction Technology.
Note: Position your mouth about 1/2” away from the microphone hole and speak in a normal voice.

- ⑳ Microphone Speaker
Audio heard through internal radio speaker is heard through speaker inside the microphone.
- ㉑ **[UP(▲)] / [DOWN(▼)]** Keys
The **[UP(▲)]** and **[DOWN(▼)]** on the microphone function the same as the **CH** knob on the front panel of the transceiver.
- ㉒ **[16/9]** Key
Pressing the **[16/9]** key immediately recalls channel 16 from any location. Press and hold the **[16/9]** key to recall channel 9. Pressing the **[16/9]** key again will revert the radio to the previous selected channel.

10 BASIC OPERATION

10.1 PROHIBITED COMMUNICATIONS

The FCC prohibits the following communications:

- False distress or emergency messages;
- Messages to “any boat” except in emergencies and radio tests;
- Messages to or from a vessel on land;
- Transmission while on land;
- Obscene, indecent, or profane language (potential fine of \$10,000).

10.2 RECEPTION

1. After the transceiver has been installed, ensure that the power supply and antenna are properly connected.
2. Press and hold the **PWR/VOL** knob until the radio turns on.
3. Rotate the **SQL** knob fully counterclockwise. This state is known as “squelch off”.
4. Turn up the **PWR/VOL** knob until noise or audio from the speaker is at a comfortable level.
5. Rotate the **SQL** knob clockwise until the random noise disappears. This state is known as the “squelch threshold.”
6. Rotate the **CHANNEL** knob to select the desired channel. Refer to the channel chart on page 105 for available channels.
7. When a message is received, adjust the volume to the desired listening level. The “**QUEY**” indicator on the display indicates communications is being received.

10.3 TRANSMISSION

1. Perform steps 1 through 6 of RECEPTION.
2. Before transmitting, monitor the channel to ensure it is clear.
THIS IS AN FCC REQUIREMENT!
3. Press the **PTT** (push-to-talk) switch. The “**TX**” indicator on the LCD is displayed.
4. Speak slowly and clearly into the microphone.
5. When the transmission is finished, release the **PTT** switch.

NOTE

This is a noise-canceling microphone. Position the Oval Slot label “**MIC**” within 1/2 inch (1.3 cm) from the mouth for optimum performance.

10.4 TRANSMIT TIME - OUT TIMER (TOT)

When the **PTT** switch on the microphone is held down, transmit time is limited to 5 minutes. This limits unintentional transmissions due to a stuck microphone. About 10 seconds before automatic transmitter shutdown, a warning beep will be heard from the speaker(s). The transceiver will automatically go to receive mode, even if the **PTT** switch is continually held down. Before transmitting again, the **PTT** switch must first be released and then pressed again.

10.5 SIMPLEX/DUPLEX CHANNEL USE

Refer to the VHF MARINE CHANNEL CHART (page 105) for instructions on use of simplex and duplex channels.

NOTE

All channels are factory-programmed in accordance with FCC (USA), Industry Canada (Canada), and International regulations. Mode of operation cannot be altered from simplex to duplex or vice-versa.

10.6 DISPLAY TYPE

The **GX2000/GX2100** display can be setup to show displays other than the default "NORMAL" VHF display by using the procedure below:

1. Press and hold down the **[CALL(MENU)]** key until "Setup Menu" appears, then select "GENERAL SETUP" with the **CHANNEL** knob.
2. Press the **[SELECT]** soft key, then rotate the **CHANNEL** knob to select "DISPLAY".
3. Press the **[SELECT]** soft key.
4. Rotate the **CHANNEL** knob to select desired screen "NORMAL", "AIS", "COMPASS", or "WAYPOINT".
5. Press the **[SELECT]** soft key to store the selected setting.
6. Press the **[QUIT]** soft key several times to return to radio operation.

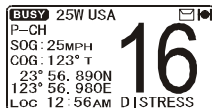
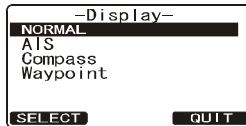
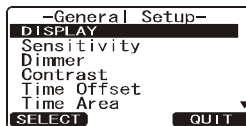
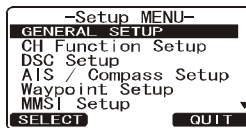

"NORMAL" DISPLAY

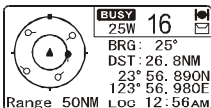

"AIS" DISPLAY

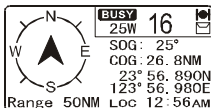

"COMPASS" DISPLAY

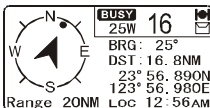

"WAYPOINT" DISPLAY

10.7 USA, CANADA, AND INTERNATIONAL MODE

To change the channel group from USA to Canada or International:

1. Press and hold down the [**CALL(MENU)**] key until “Setup Menu” appears.
2. Rotate the **CHANNEL** knob to select “**CH FUNCTION SETUP**”.
2. Press the [**SELECT**] soft key, then rotate the **CHANNEL** knob to select “**CH GROUP**”.
3. Press the [**SELECT**] soft key.
4. Rotate the **CHANNEL** knob to select desired channel group “**USA**”, “**INTL**”, or “**CANADA**”.
5. Press the [**ENT**] soft key to store the selected setting.
6. Press the [**QUIT**] soft key several times to return to radio operation.

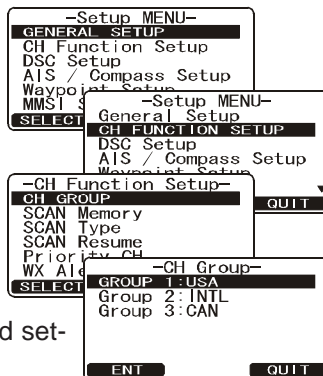

10.8 NOAA WEATHER CHANNELS

1. To receive a NOAA weather channel, press and hold the [**CLR(WX)**] key for 2 seconds from any channel. The transceiver will go to the last selected weather channel.
2. Rotate the **CHANNEL** knob to select a different NOAA weather channel.
3. To exit from the NOAA weather channels, press the [**CLR(WX)**] key. The transceiver returns to the channel it was on prior to a weather channel.

10.8.1 NOAA Weather Alert

In the event of extreme weather disturbances, such as storms and hurricanes, the NOAA (National Oceanic and Atmospheric Administration) sends a weather alert accompanied by a 1050 Hz tone and subsequent weather report on one of the NOAA weather channels. When the Weather Alert feature is enabled (see section “**12.18 WX ALERT**”), the transceiver is capable of receiving this alert if the following is performed:

1. Program NOAA weather channels into the transceiver’s memory for scanning. Follow the same procedure as for regular channels under section “**10.14.3 Memory Scanning (M-SCAN)**.”
2. Press the [**SCAN**] key once to start memory scanning.
3. The programmed NOAA weather channels will be scanned along with the regular-programmed channels. However, scanning will not stop on a normal weather broadcast unless a NOAA alert is received.
4. When an alert is received on a NOAA weather channel, scanning will stop and the transceiver will emit a loud beep to alert the user of a NOAA broadcast.
5. Press the [**CLR(WX)**] key to stop the alert and receive the weather report.

NOTE

If the [CLR(WX)] key is not pressed the alert will sound for 5 minutes and then the weather report will be received.

NOTE

While listening to a weather channel, the radio can decode a weather alert and sound an alarm.

10.8.2 NOAA Weather Alert Testing

NOAA tests the alert system every Wednesday between 11AM and 1PM. To test the **GX2000/GX2100**'s NOAA Weather feature, on Wednesday between 11AM and 1PM, setup as in section "10.8.1 NOAA Weather Alert" and confirm the alert is heard.

10.9 DUAL WATCH (TO CHANNEL 16)

Dual watch is used to scan two channels for communications. One channel is a normal VHF channel and the other is the priority, channel 16. When a signal is received on the normal channel the radio briefly switches between the normal channel and Channel 16 to look for a transmission. If the radio receives communications on channel 16 the radio stops and listens to Channel 16 until communication ends and then starts Dual watch scan again.

1. Adjust the **SQL** knob until the background noise disappears.
2. Select the channel you wish to dual watch to the priority channel 16.
3. Press the one of the Soft keys, then press the [DW] key.

The display will scan between CH16 and the channel that was selected in step 2.

If a transmission is received on the channel selected in step 2, the **GX2000/GX2100** will dual watch to CH16.

4. To stop Dual Watch press the [DW] key again.

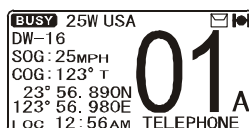

NOTE

The priority channel may be changed from Ch16 to another channel. Refer to section "12.17 PRIORITY CHANNEL".

10.10 SCANNING

Allows the user to select the scan type from Memory scan or Priority scan. “Memory scan” scans the channels that were programmed into memory. “Priority scan” scans the channels programmed in memory with the priority channel.

10.10.1 Selecting the Scan Type

1. Press and hold down [CALL(MENU)] key until “Setup Menu” appears.
2. Rotate the CHANNEL knob to select “CH FUNCTION SETUP”.
3. Press the [SELECT] soft key, then select “SCAN TYPE” with the CHANNEL knob.
4. Press the [SELECT] soft key.
5. Rotate the CHANNEL knob to select “PRIORITY SCAN” or “MEMORY SCAN”.
6. Press the [SELECT] soft key to store the selected setting.
7. Press the [QUIT] soft key several times to return to radio operation.

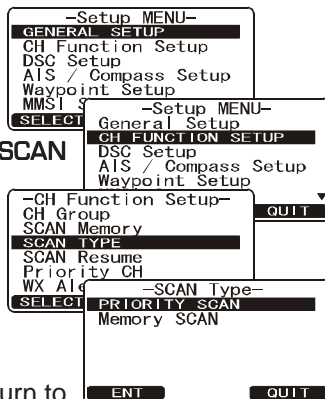

10.10.2 Programming Scan Memory

1. Press and hold down the [CALL(MENU)] key until “Setup Menu” appears.
2. Rotate the CHANNEL knob to select “CH FUNCTION SETUP”.
3. Press the [SELECT] soft key, then rotate the CHANNEL knob to select “SCAN MEMORY”.
4. Press the [SELECT] soft key.
5. Rotate the CHANNEL knob to select a desired channel to be scanned, then press the [ADD] key. “MEM” icon appears on the display, which indicates the channel has been selected to the scan channel.
6. Repeat step 5 for all the desired channels to be scanned.
7. To DELETE a channel from the list, select the channel then press the [DELETE] key. “MEM” icon disappears from the display.
8. When you have completed your selection, press the [QUIT] key several times to return to radio operation.

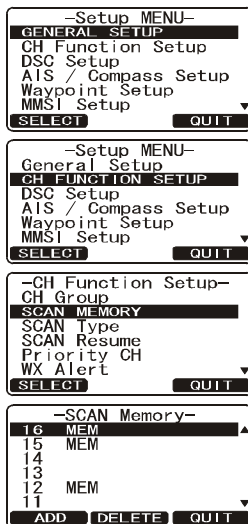

10.10.3 Memory Scanning (M-SCAN)

1. Adjust the **SQL** knob until background noise disappears.
2. Press the one of the soft key momentarily, then press the [**SCAN**] key. “**M-SCAN**” appears on the display. Scanning will proceed from the lowest to the highest programmed channel number and Pre-set channel (described in the next chapter) and will stop on a channel when a transmission is received.
3. The channel number will blink during reception.
4. To stop scanning, press the [**16/9**] or [**CLR(WX)**] key.

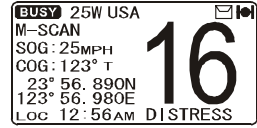

10.10.4 Priority Scanning (P-SCAN)

In the default setting, Channel 16 is set as the priority channel. You may change the priority channel to the desired channel from Channel 16 by the Radio Setup Mode, refer to section “**12.17 PRIORITY CHANNEL**”.

1. Adjust the **SQL** knob until background noise disappears.
2. Press the one of the soft key momentarily, then press the [**SCAN**] key. “**P-SCAN**” appears on the display. Scanning will proceed between the memorized channels and Preset channel (described in next chapter) and the priority channel. The priority channel will be scanned after each programmed channel.
3. To stop scanning, press the [**16/9**] or [**WX**] key.

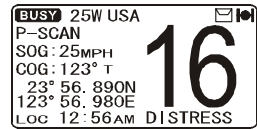

10.11 PRESET CHANNELS (0 ~ 9): INSTANT ACCESS

10 Preset Channels can be programmed for instant access. Pressing the [PRESET] key (one of the Programmable key command) activates the user assigned channel bank. If the [PRESET] key is pressed and no channels have been assigned, an alert beep will be emitted from the speaker.

Before beginning the Instant Access operation, assign the "PRESET" command into the one of the Programmable key, referring to section "12.12 SOFT KEY".

10.11.1 Programming

1. Rotate the **CHANNEL** knob to select the channel to be programmed.
2. Press the one of the Programmable key momentarily to indicate these function on the LCD, then press and hold the [PRESET] key until the preset channel number "PRESET0" is displayed.
3. Release the [PRESET] key. The preset channel number "PRESET0" disappears from the display after five second when releasing the [PRESET] key.
4. Repeat steps 2 and 3 to program the desired channels into Preset Channels "1" ~ "9".
5. To delete a Preset Channel: press the one of the Programmable key momentarily to indicate these function on the LCD, then press and hold the [PRESET] key until the preset channel number to be deleted is displayed.

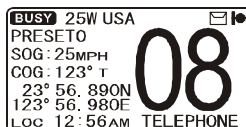

10.11.2 Operation

Pressing the [PRESET] key will toggle between Preset Channels "0" through "9" and the last selected "regular" channel. The Preset Channel number will disappear after five second.

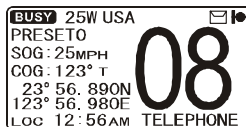

10.12 PA/FOG OPERATION

The **GX2000/GX2100** has a 30W Hailer built-in and can be used with any 4 Ohm PA Horns. Standard Horizon offers a small and a large PA horn called the 220SW and 240SW. When in Hail mode the PA speaker Listen's Back (acts as a microphone and sends sound to the front panel speaker and the speaker mic: **GX2100** only) through the PA horn speaker which provides two-way communications through the PA horn speaker.

NOTE

When in PA or FOG mode, the **GX2000/GX2100** will receive on the last selected VHF channel before entering into the PA or FOG mode and receive DSC calls.

PA HAIL mode:

PA HAIL mode allows the transceiver to be used as a power hailer when an optional STANDARD HORIZON 220SW or 240SW HAIL/PA speaker is installed. The Hail mode has a listen-back feature (**GX2100** only) which provides two way communication through the HAIL/PA speaker.

FOG HORN mode:

Automatic signaling is transmitted through the HAIL/PA speaker. When the Fog horn, Bells or Whistle signal is not being outputted the **GX2100** listens back through the connected PA Horn speaker (**GX2000** dose not have listen back).

10.12.1 Operating the PA HAIL mode

1. Press the one of the Soft keys momentarily, then press the **[PA/FOG]** soft key.
2. Rotate the **CHANNEL** knob to select "PA", then press the **[SELECT]** soft key.
3. Press the **PTT** switch to speak through the HAIL/PA speaker.
Rotate the **CHANNEL** knob to control the AF output level. The AF output level can be set from 0 to 30 watts.
4. To listen back (**GX2100** only), rotate the **PWR/VOL** knob.

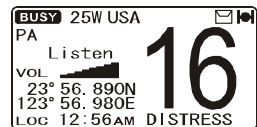

5. To exit the PA HAIL mode, press the [CLR(WX)] key.

10.12.2 Operating the FOG HORN mode

Operator can select from “Underway”, “Stop”, “Sail”, “Tow”, “Aground”, “Anchor”, “Horn”, and “Siren”.

1. Press the one of the soft keys momentarily, then press the [PA/FOG] soft key.
2. Rotate the **CHANNEL** knob to select “FOG”, then press the [SELECT] soft key.
3. Rotate the **CHANNEL** knob to select one of the eight functions described above.
4. Press the [ENT] soft key.
5. On the “Horn” and “Siren” modes, press the **PTT** switch to activate the tone through the HAIL/PA speaker.

Rotate the **CHANNEL** knob to control the AF output level. The AF output level can be set from 0 to 30 watts.

6. To listen back (**GX2100** only), rotate the **PWR/VOL** knob.
7. To exit the FOG HORN mode, press the [CLR(WX)] key.

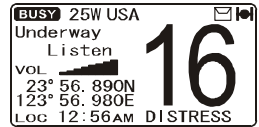
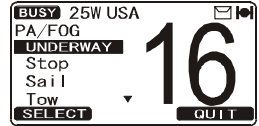
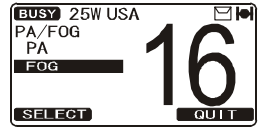

10.12.3 Fog Signal Timing Chart

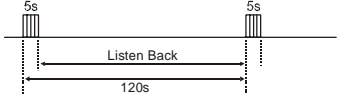
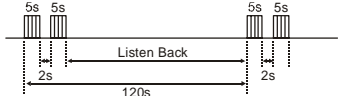
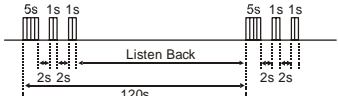
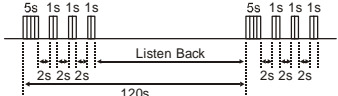
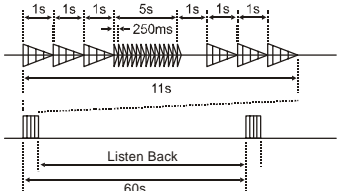
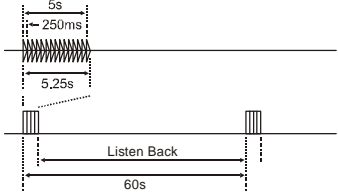
TYPE	PATTERN	USAGE
UNDERWAY	<p>One 5-second blasts every 120 seconds.</p> 	Motor vessel underway and making way.
STOP	<p>Two 5-second blasts (separated by 2 seconds) every 120 seconds.</p> 	Motor vessel underway but stopped (not making way).
SAIL	<p>One 5-second blasts followed by two 1-second blasts (separated by 2 seconds) every 120 seconds.</p> 	Sailing vessel underway, fishing vessel (underway or anchored), vessel not under command, a vessel restricted in her ability to maneuver (underway or at anchor), or a vessel towing or pushing another ahead.
TOW	<p>One 5-second blasts followed by three 1-second blasts (separated by 2 seconds) every 120 seconds.</p> 	Vessel under tow (manned).
AGROUND	<p>One 11-second rings every 60 seconds.</p> 	Vessel is aground.
ANCHOR	<p>One 5-second rings every 60 seconds.</p> 	Vessel is at anchor.

10.13 INTERCOM OPERATION

To access the following Intercom functions one of the soft key must be setup as IC. Refer to section “12.12 SOFT KEY”.

In addition an optional **RAM3** must be connected to perform intercom functions between the radio and the **RAM3**.

10.13.1 Communication

1. Press the one of the soft keys momentarily, then press the **[IC]** key to enable the intercom mode.
2. When the intercom mode is enabled, “Intercom” is displayed on the radio and **CMP30 (RAM3)** Remote Station Microphone.
3. Press the **PTT** switch on the radio. “Talk” will be shown on the display.

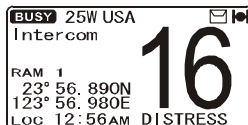

Note: A warning beep will be heard when the Radios **PTT** and **CMP30 (RAM3) PTT** are pushed at the same time.

4. Speak slowly and clearly into the microphone, hold the microphone about 1/2 inch away from your mouth.
5. When finished, release the **PTT** switch.
6. Press the **[CLR(WX)]** key to exit intercom mode and revert to radio mode.

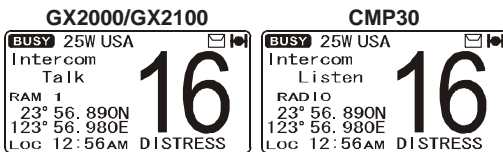

(GX2000/GX2100's PTT switch is pressed)

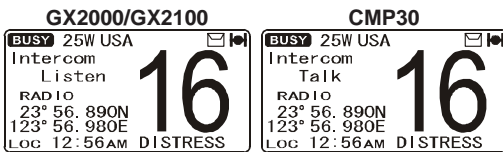

(CMP30's PTT switch is pressed)

10.13.2 Calling

Press and holding the **[IC]** soft key when in intercom mode on either the radio or **CMP30 (RAM3)** mic will produce a calling beep to the other station.

10.14 VOICE SCRAMBLER

If privacy of communications is desired, a **CVS2500** 4 code voice scrambler (VS) can be installed in the transceiver. Contact your Dealer to have a **CVS2500** installed. Refer to the section “**12.21 SCRAMBLER**” to program the voice scrambler.

1. Select a channel that was programmed for scrambler mode (“**Vs**” and scrambler number will appear on the display).
2. Monitor the channel before transmitting.
3. Transmit the voice message. The signal sent will be scrambled.

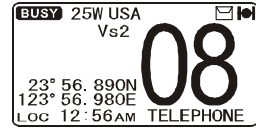

11 DIGITAL SELECTIVE CALLING

11.1 GENERAL

WARNING

This radio is designed to generate a digital maritime distress and safety call to facilitate search and rescue. To be effective as a safety device, this equipment must be used only within communication range of a shore-based VHF marine channel 70 distress and safety watch system. The range of signal may vary but under normal conditions should be approximately 20 nautical miles.

NOTE

A DSC Warning sticker is included with the **GX2000/GX2100**. To comply with FCC regulations this sticker must be mounted in a location that can be easily viewed from the location of the **GX2000/GX2100**.

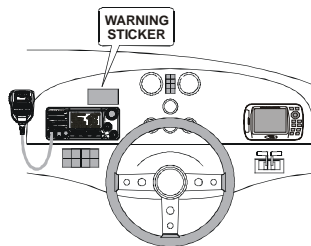

Digital Selective Calling is a semi-automated method of establishing a radio call, it has been designated by the International Maritime Organization (IMO) as an international standard for establishing VHF, MF and HF radio calls. It has also been designated as part of the Global Maritime Distress and Safety System (GMDSS). It is planned that DSC will eventually replace aural watches on distress frequencies and will be used to announce routine and urgent maritime safety information broadcasts.

This new system allows mariners to instantly send a distress call with GPS position (when connected to the transceiver) to the US Coast Guard and other vessels within range of the transmission. DSC will also allow mariners to initiate or receive Distress, Urgency, Safety, Routine, POSITION REQUEST, POSITION SEND, AUTO POLLING and Group calls to or from another vessel equipped with a DSC transceiver.

11.2 MARITIME MOBILE SERVICE IDENTITY (MMSI)

11.2.1 What is an MMSI?

An MMSI is a nine digit number used on Marine Transceivers capable of using Digital Selective Calling (DSC). This number is used like a telephone number to selectively call other vessels.

THIS NUMBER MUST BE PROGRAMMED INTO THE RADIO TO OPERATE THE GX2000/GX2100 DSC FUNCTIONS.

How can I obtain an MMSI assignment?

In the USA, visit the following websites to register:

<http://www.boatus.com/mmsi/> or

http://seatow.com/boating_safety/mmsi.asp

In the Canada, visit

<http://www.ic.gc.ca/epic/site/smt-gst.nsf/en/sf01032e.html> or

<http://www.usps.org/php/mmsi/rules.php>

11.2.2 Programming the MMSI

WARNING

A user MMSI can be inputted only once. Therefore please be careful not to input the incorrect MMSI number. If you needs to change the MMSI number after it has been entered, the radio will have to be returned to Factory Service. Refer to the section “15.2. FACTORY SERVICE.”

1. Press and hold down the [CALL(MENU)] key until the “Setup Menu” appears.
2. Rotate the CHANNEL knob to select “MMSI SETUP”.
3. Press the [SELECT] soft key.
4. Rotate the CHANNEL knob to select the first number of your MMSI, then press the [SELECT] soft key to step to the next number.
5. Repeat step 4 to set your MMSI number (nine digits).
6. If a mistake was made entering in the MMSI number, press the [BACK] key until the wrong number is selected, then rotate the CHANNEL knob to correct the entry.
7. When finished programming the MMSI number, press and hold the [SELECT] soft key. The radio will ask you to input the MMSI number again. Use steps 4 - 6 above.
8. After the second number has been input, press the CHANNEL knob to store the MMSI.
9. Press the [QUIT] key to return to radio operation.

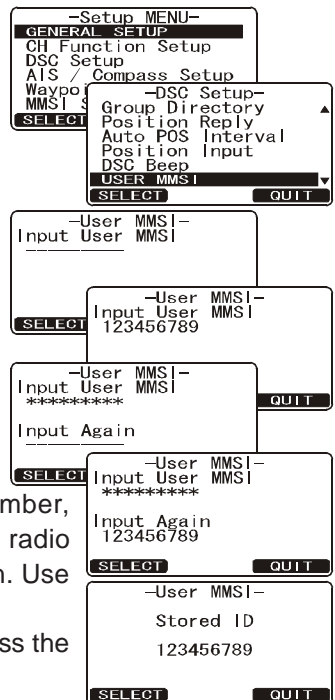

NOTE

To view your MMSI after programming to ensure it is correct, perform steps 1~3. Look that the MMSI number shown on the display is correct.

11.3 DSC DISTRESS CALL

The **GX2000/GX2100** is capable of transmitting and receiving DSC Distress messages to all DSC radios. The **GX2000/GX2100** may be connected to a GPS to also transmit the Latitude, Longitude of the vessel.

11.3.1 Transmitting a DSC Distress Call

NOTE

To be able to transmit a DSC distress call an MMSI number must be programmed, refer to section “**11.2.2 Programming the MMSI.**”

In order for your ships location to be transmitted a GPS must be connected to the **GX2000/GX2100**, refer to section “**8.4 ACCESSORY CABLE.**”

1. Lift the red spring loaded DISTRESS cover and press the [DISTRESS] key. The “DISTRESS ALERT” menu will appear on the display.
2. Press and hold the [DISTRESS] key. The radios display will count down (3-2-1) and then transmit the Distress call. The backlight of the display and keypad flashes while the radios display is counting down.
3. When the distress signal is sent, the transceiver watches for a transmission between CH16 and CH70 until an acknowledgment signal is received.
4. If an acknowledgement is received, select channel 16 and advise your distress situation.
5. If no acknowledgment is received, the distress call is repeated in 4 minute intervals until a DSC acknowledgment is received.
6. When a DSC Distress acknowledgment is received, a distress alarm sounds and channel 16 is automatically selected. The display shows the MMSI of the ship responding to your distress.
RECEIVED ACK: acknowledgment signal is received.
RECEIVED RLY: relay signal is received from another vessel or coast station.
7. Press the **PTT** button and state your name, vessel name, number of persons on board and the distress situation, then say over. wait for a reply from the acknowledging ship.
8. To cancel the DSC distress alarm signal from the speaker, press any key.

```
!DISTRESS ALERT!  
Nature of:Undesignate  
Position: 23° 56.890N  
123° 56.980E  
POS Time: 12:28  
  
Time for 3sec  
NATURE POS/TM QUIT
```

```
!DISTRESS ALERT!  
Nature of:Undesignate  
Position: 23° 56.890N  
123° 56.980E  
POS Time: 12:28  
  
Time for 3sec
```

```
!DISTRESS ALERT!  
Nature of:Undesignate  
Position: 23° 56.890N  
123° 56.980E  
POS Time: 12:28  
  
Transmitting
```

```
!DISTRESS ALERT!  
Nature of:Undesignate  
Position: 23° 56.890N  
123° 56.980E  
POS Time: 12:28  
TX in: 02:25  
Wait for ACK  
PAUSE CANCEL
```

```
!DISTRESS ALERT!  
Received Acknowledged  
Name:USCG  
ID:001234567  
  
Since: 00:15  
  
OK
```

Transmitting a DSC Distress Alert with Nature of Distress

The **GX2000/GX2100** is capable of transmitting a DSC Distress Alert with the following “Nature of Distress” categories:

Undesignated, Fire, Flooding, Collision, Grounding, Capsizing, Sinking, Adrift, Abandoning, Piracy, MOB

1. Lift the red spring loaded **DISTRESS** cover and press the [**DISTRESS**] key. The “**DISTRESS ALERT**” menu will appear on the display.
2. Press the [**NATURE**] soft key, then rotate the **CHANNEL** knob to select the desired nature of distress category.
3. Press and hold the [**DISTRESS**] key. The radios display will count down (3-2-1) and then transmit the Distress call. The backlight of the display and keypad flashes while the radios display is counting down.
4. When the distress signal is sent, the transceiver watches for a transmission between CH16 and CH70 until an acknowledgment signal is received.
5. If no acknowledgment is received, the DSC distress call is repeated in 4 minute intervals until an acknowledgment is received.
6. When a DSC Distress acknowledgment is received, a distress alarm sounds and channel 16 is automatically selected. The display shows the MMSI of the ship responding to your distress.
RECEIVED ACK: acknowledgment signal is received.
RECEIVED RLY ACK: relay acknowledgment signal is received from another vessel or coast station.

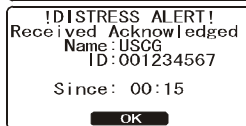
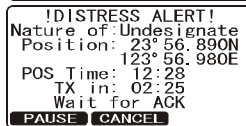
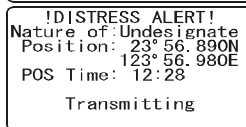
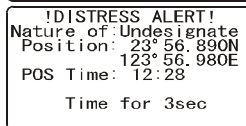
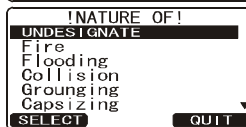
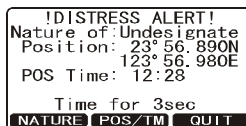

Transmitting a DSC Distress Alert with Manual Position of Input

When the **GX2000/GX2100** is not connected to a GPS receiver, you may input the latitude/longitude of your vessel manually and may send DSC Distress Alert.

1. Lift the red spring loaded **DISTRESS** cover and press the [**DISTRESS**] key. The “**DISTRESS ALERT**” menu will appear on the display.
2. Press the [**POS/TM**] soft key.

3. Enter the latitude/longitude of your vessel and your local UTC time in the 24-hour notation by the **CHANNEL** knob. Rotate the **CHANNEL** knob to select the number and press the **[ENT]** soft key to move the cursor to the next character. You may backspace the cursor by pressing the **[BACK]** soft key, if you make a mistake.

4. When you have completed your selection, press and hold in the **[ENT]** soft key for two seconds to save the setting.

5. Press and hold the **[DISTRESS]** key. The radios display will count down (3-2-1) and then transmit the Distress call. The backlight of the display and keypad flashes while the radios display is countdown.

6. When the distress signal is sent, the transceiver "shadow-watches" for a transmission between CH16 and CH70 until an acknowledgment signal is received.

7. If no acknowledgment is received, the distress call is repeated in 4 minute intervals until an acknowledgment is received.

8. When a DSC Distress acknowledgment is received, a distress alarm sounds and channel 16 is automatically selected. The display shows the MMSI of the ship responding to your distress.

RECEIVED ACK: acknowledgment signal is received.

RECEIVED RLY ACK: relay acknowledgment signal is received from another vessel or coast station.

9. Press the **PTT** button and state your name, vessel name, number of persons on board and the distress situation, then say over. wait for a reply from the acknowledging ship.

10. To cancel the DSC Distress alarm signal from the speaker, press any key.

Cancel a DSC Distress Call

If a DSC Distress call was sent by error the **GX2000/GX2100** allows you to send a message to other vessels to cancel the Distress Call that was made in error.

Press the **[CANCEL]** soft key, then press **[YES]** soft key.

```

!DISTRESS ALERT!
Nature of: Undesignate
Position: 23° 56. 890N
          123° 56. 980E
POS Time: 12:28

Time for 3sec
[NATURE] [POS/TM] [QUIT]
  
```

```

-POS/POS Time Input-
Position:  ___° __. ___
           ___° __. ___
POS Time:  --:-- [UTC]

[ENT] [QUIT]
  
```

```

-POS/POS Time Input-
Position: 23° 56. 890N
          123° 56. 980E
POS Time: 12:28 [UTC]

[ENT] [QUIT]
  
```

```

!DISTRESS ALERT!
Nature of: Undesignate
Position: 23° 56. 890N
          123° 56. 980E
POS Time: 12:28

Time for 3sec
  
```

```

!DISTRESS ALERT!
Nature of: Undesignate
Position: 23° 56. 890N
          123° 56. 980E
POS Time: 12:28

Transmitting
  
```

```

!DISTRESS ALERT!
Nature of: Undesignate
Position: 23° 56. 890N
          123° 56. 980E
POS Time: 12:28
TX in: 02:25
Wait for ACK

[PAUSE] [CANCEL]
  
```

```

!DISTRESS ALERT!
Received Acknowledged
Name: USCG
ID: 001234567

Since: 00:15

[OK]
  
```

```

!DISTRESS ALERT!
Nature of: Undesignate
Position: 23° 56. 890N
          123° 56. 980E
POS Time: 12:28
TX in: 02:25
Wait for ACK

[PAUSE] [CANCEL]
  
```

```

!DISTRESS CANCEL!

Transmit?

[YES] [NO]
  
```

11.3.2 Receiving a DSC Distress Call

1. When a DSC Distress call is received, an emergency alarm sounds.

Then channel 16 is automatically selected.

2. Press any key to stop the alarm.
3. The display shows the position of the vessel in distress.

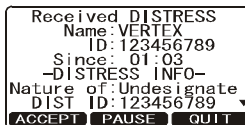

4. If you wish to display the position of the vessel in distress on the the “WAYPOINT” screen, go to next step, otherwise press the [QUIT] soft key to return to radio operation.

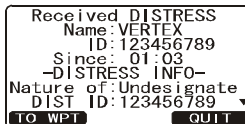

5. Press the [WPT] soft key to enter the “Waypoint Input” menu, then enter the desired waypoint name (up to 11 characteres), described previously (select the letter/number by rotating the CHANNEL knob and move the cursor by pressing the [ENT]/[BACK] soft key).

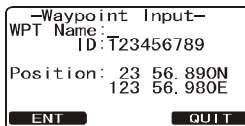

6. The ID is the MMSI from the vessel in distress.
7. When you are finished entering the waypoint name, press and hold the [TO WPT] soft key to replace the display to the “WAYPOINT” Screen. The display indicates the distance and direction of the distressed vessel, and also the compass indicates the distressed vessel by dot (●).

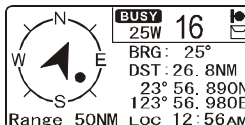

8. To return to the radio operation:
 - 1) Press and hold down the [CALL(MENU)] key until “Setup Menu” appears.
 - 2) Rotate the CHANNEL knob to select “DSC SETUP” menu.
 - 3) Press the [SELECT] soft key, then select “GENERAL SETUP” with the CHANNEL knob.
 - 4) Press the [SELECT] soft key, then select “NORMAL” with the CHANNEL knob.
 - 5) Press the [SELECT] soft key to return to radio operation.

NOTE

You must continue monitoring channel 16 as a coast station may require assistance in the rescue attempt.

11.4 ALL SHIPS CALL

The All Ships Call function allows contact to be established with DSC equipped vessels without having their MMSI in the individual calling directory. Also, priority for the call can be designated as Urgency or Safety.

URGENCY Call: This type of call is used when a vessel may not truly be in distress, but have a potential problem that may lead to a distress situation. This call is the same as saying PAN PAN PAN on channel 16.

SAFETY Call: Used to transmit boating safety information to other vessels. This message usually contains information about an overdue boat, debris in the water, loss of a navigation aid or an important meteorological message. This call is the same as saying Securite, Securite, Securite.”

11.4.1 Transmitting an All Ships Call

1. Press the **[CALL(MENU)]** key. The “**DSC Menu**” will appear.
2. Rotate the **CHANNEL** knob to select “**All SHIPS**”.
3. Press the **[SELECT]** soft key. (To cancel, press the **[QUIT]** key.)
4. Rotate the **CHANNEL** knob to select the nature of call (“**SAFETY**” or “**URGENCY**”), then press the **[SELECT]** soft key.
5. Rotate the **CHANNEL** knob to select the operating channel you want to communicate on, then press the **[SELECT]** soft key. If the channel you want to use is not listed, press the **[MANUAL]** soft key, then rotate the **CHANNEL** knob to select the operating channel you want to communicate on, then press the **[SELECT]** soft key.
6. Press the **[YES]** soft key to transmit the selected type of all ships DSC call.
7. After the All Ships Call is transmitted, the transceiver will switch to the selected channel.
8. Listen to the channel to make sure it is not busy, then key the microphone and say PAN PAN PAN or “Securite, Securite, Securite” depending on the priority of the call.
9. Press the **[QUIT]** soft key to exit the ALL ship call menu.

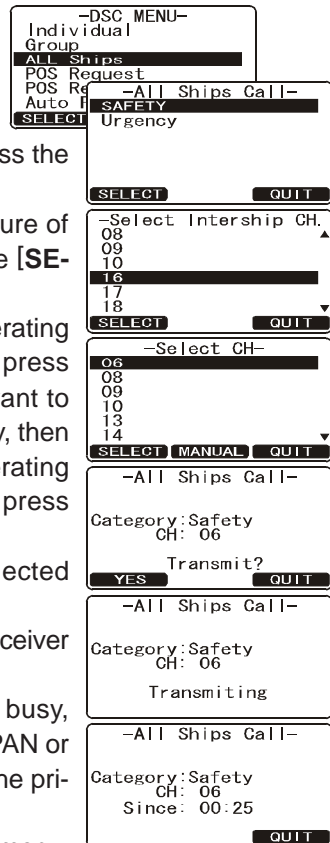

11.4.2 Receiving an All Ships Call



1. When an all ships call is received, an emergency alarm will sound.

The radio will automatically change to the requested channel and the display shows the MMSI of the vessel transmitting the All Ships Call.

2. Press any key to stop the alarm.
3. Monitor the requested channel until the ALL SHIPS voice communication is completed.
4. Press the **[CALL(MENU)]** key to return to the channel display.

Received All Ships
Name: VERTEX
ID: 123456789
Category: Safety
CH: 06
Since: 01:03
ACCEPT PAUSE QUIT

Received All Ships
Name: VERTEX
ID: 123456789
Category: Safety
CH: 06
Since: 01:03
QUIT

BUSY 25W USA  
SOG: 25MPH
COG: 123° T
23° 56.890N
123° 56.980E
06
LOC 12:56AM DISTRESS

11.5 INDIVIDUAL CALL

This feature allows the **GX2000/GX2100** to contact another vessel with a DSC VHF radio and automatically switch the receiving radio to a desired communications channel. This feature is similar to calling a vessel on CH16 and requesting to go to another channel (switching to the channel is private between the two stations). Up to 80 Individual contacts may be programmed.

11.5.1 Setting up the Individual / Position Call Directory

The **GX2000/GX2100** has a DSC directory that allows you to store a vessel or person's name and the MMSI number associated with vessels you wish to transmit Individual calls, Position Requests and Position Send transmissions.

To transmit an Individual call you must program this directory with information of the persons you wish to call, similar to a cellular phones telephone directory.

1. Press and hold down the **[CALL(MENU)]** key until "Setup Menu" appears.
2. Rotate the **CHANNEL** knob to select "DSC SETUP" menu.
3. Press the **[SELECT]** soft key, then select "INDIVIDUAL DIRECTORY" with the **CHANNEL** knob.
4. Press the **[SELECT]** soft key.
5. Select "ADD" with the **CHANNEL** knob, then press the **[SELECT]** soft key.
6. Rotate the **CHANNEL** knob to scroll through the first letter of the name of the vessel or person you want to reference in the directory.
7. Press the **[ENT]** soft key to store the first letter in the name and step to the next letter to the right.
8. Repeat step 6 and 7 until the name is complete. The name can consist of up to eleven characters, if you do not use all eleven characters press the **[ENT]** soft key to move to the next space. This method can also be used to enter a blank space in the name. If a mistake was made entering in the name repeat pressing the **[BACK]** soft key until the wrong character is selected, then rotate the **CHANNEL** knob to correct the entry.
9. After the eleventh letter or space has been entered, press and hold the **[ENT]** soft key to advance to the MMSI (Maritime Mobile Service Identity Number) number entry.
10. Rotate the **CHANNEL** knob to scroll through numbers, 0-9. To enter the desired number and move one space to the right by pressing the **[ENT]**

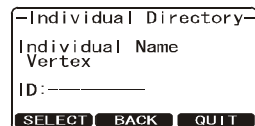
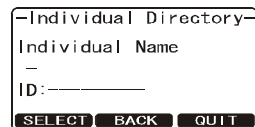
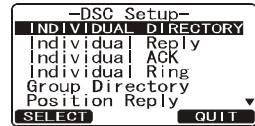

soft key. Repeat this procedure until all nine space of the MMSI number are entered.

11. If a mistake was made entering in the MMSI number repeat pressing the **[BACK]** soft key until the wrong number is selected, then rotate the **CHANNEL** knob to correct the entry.
12. To store the data entered, press and hold the **[ENT]** soft key.
13. To enter another individual address, repeat steps 5 through 12.
14. Press the **[QUIT]** soft key several times to return to radio operation.



11.5.2 Setting up Individual Reply

This menu item sets up the radio to automatically (default setting) or manually respond to a DSC Individual call requesting you to switch to a working channel for voice communications. When Manual is selected the MMSI of the calling vessel is shown allowing you to see who is calling. This function is similar to caller id on a cellular phone.

1. Press and hold down the **[CALL(MENU)]** key until **"Setup Menu"** appears.
2. Rotate the **CHANNEL** knob to select **"DSC SETUP"** menu.
3. Press the **[SELECT]** soft key, then select **"INDIVIDUAL REPLY"** with the **CHANNEL** knob.
4. Press the **[SELECT]** soft key.
5. Rotate the **CHANNEL** knob to select **"AUTO"** or **"MANUAL"**.
6. Press the **[SELECT]** soft key to store the selected setting.
7. Press the **[QUIT]** soft key several times to return to radio operation.

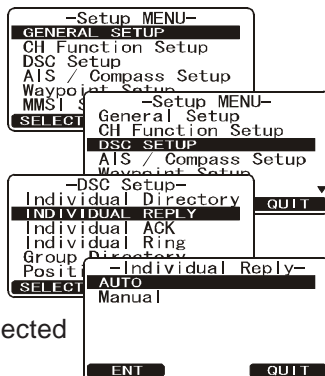

11.5.3 Setting up Individual/Group Call Ringer

When a Individual Call or Group Call is received the radio will produce a ringing sound for 2 minutes. This selection allows the Individual Call ringer time to be changed.

1. Press and hold down the **[CALL(MENU)]** key until **"Setup Menu"** appears.
2. Rotate the **CHANNEL** knob to select **"DSC SETUP"** menu.
3. Press the **[SELECT]** soft key, then select **"INDIVIDUAL RING"** with the **CHANNEL** knob.
4. Press the **[SELECT]** soft key.
5. Rotate the **CHANNEL** knob to select ringing

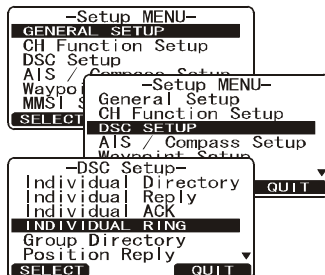

time of a Individual Call.

6. Press the [ENT] soft key to store the selected setting.
7. Press the [QUIT] soft key several times to return to radio operation.



The **GX2000/GX2100** has the capability to turn off the Individual and Group call ringer.

1. Press and hold down the [CALL(MENU)] key until "Setup Menu" appears.
2. Rotate the CHANNEL knob to select "DSC SETUP" menu.
3. Press the [SELECT] soft key, then select "DSC BEEP" with the CHANNEL knob.
4. Press the [SELECT] soft key.
5. Rotate the CHANNEL knob to select "Individual" if you wish to disable the Individual call ringer, or "Group" if you wish to disable the Group call ringer, then press the [SELECT] soft key.
6. Rotate the CHANNEL knob to select "Off".
7. Press the [ENT] soft key to store the selected setting.
8. Press the [QUIT] soft key several times to return to radio operation.

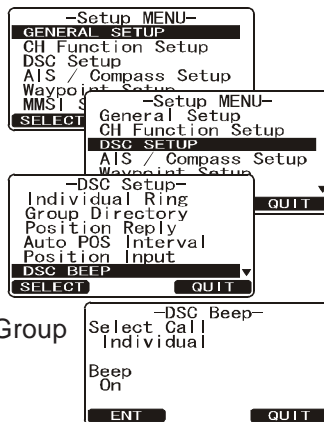

To re-enable the ringer tone, repeat the above procedure, rotating the CHANNEL knob to select "On" in step "6" above.

11.5.4 Transmitting an Individual Call

This feature allows the user to contact another vessel with a DSC radio. This feature is similar to calling a vessel on CH16 and requesting to go to another channel.

Pre-Programmed Calling

1. Press the [CALL(MENU)] key. The "DSC Menu" will appear.
2. Rotate the CHANNEL knob to select "INDIVIDUAL". (To cancel, press the [QUIT] soft key.)
3. Press the [SELECT] soft key. The transceiver will beep, and the "Last Individual Call" will appear.
4. Rotate the CHANNEL knob to select the "Individual" you want to contact.

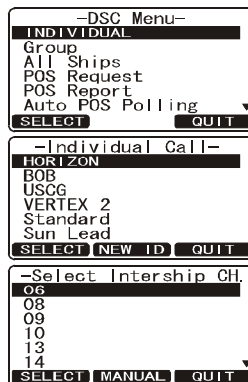

- Press the [**SELECT**] soft key, then rotate the **CH** knob to select the operating channel you want to communicate on, then press the [**SELECT**] soft key. If the channel is not shown in the list, press the [**MANUAL**] soft key, then rotate the **CHANNEL** knob to select the operating channel you want to communicate on, then press the [**SELECT**] soft key.
- Press the [**YES**] soft key to transmit the individual DSC signal.
- When an individual call acknowledgment is received, the established channel is automatically changed to the channel which is selected on step 5 above and a ringing tone sounds.
- Press the [**QUIT**] soft key to listen to the channel to make sure it is not busy, then press the microphone's **PTT** switch and talk into the microphone to the other vessel.

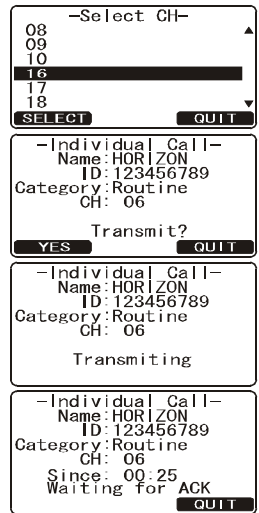

Manual Calling

You may enter an MMSI number manually to contact without storing it in the Individual Directory.

- Press the [**CALL(MENU)**] key. The “DSC Menu” menu will appear.
- Rotate the **CHANNEL** knob to select “INDIVIDUAL”. (To cancel, press the [**QUIT**] soft key.)
- Press the [**SELECT**] soft key. The transceiver will beep, and the “Last Individual Call” will appear.
- Press the [**NEW ID**] soft key, then select “MANUAL” with the **CHANNEL** knob.
- Press the [**SELECT**] soft key.
- Rotate the **CHANNEL** knob to select the first number of the MMSI which you want to contact, then press the [**SELECT**] soft key to step to the next number.
- Repeat step 6 to set the MMSI number (nine digits).
- If a mistake was made entering in the MMSI number, repeat pressing the [**BACK**] key until the wrong number is selected, then rotate the **CHANNEL** knob to correct the entry.
- When finished entering the MMSI number, press and hold the [**SELECT**] soft key.

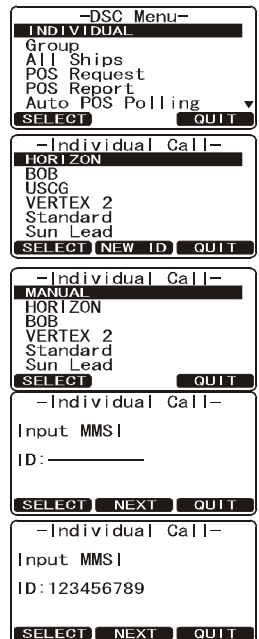

10. Press the **[SELECT]** soft key, then rotate the **CHANNEL** knob to select the operating channel you want to communicate on, then press the **[SELECT]** soft key. If the channel is not shown in the list, press the **[MANUAL]** soft key, then rotate the **CHANNEL** knob to select the operating channel you want to communicate on, then press the **[SELECT]** soft key.
11. Press the **[SELECT]** soft key again to transmit the individual DSC signal.
12. When an individual call acknowledgment is received, the established channel is automatically changed to the channel which is selected on step 5 above and a ringing tone sounds.
13. Press the **[QUIT]** soft key to listen to the channel to make sure it is not busy, then press the microphone's **PTT** switch and talk into the microphone to the other vessel.

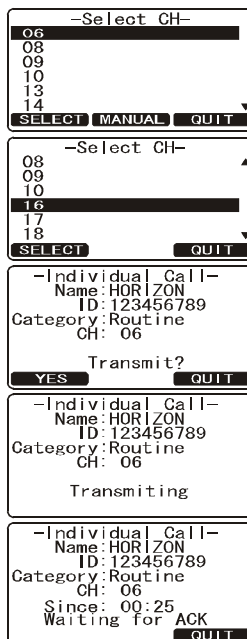

11.5.5 Receiving an Individual Call

When a Individual DSC call is received, the radio will automatically respond (Default setting) to the calling ship, and switch to the requested channel for voice communications. Refer to section "11.5.2 Setting up Individual Reply" to change the reply to manual if you want to see who is calling before replying to the call.

1. When an individual call is received, an individual call ringing alarm sounds.
The radio automatically switches to the requested channel. The display shows the MMSI of the vessel calling.
2. Press any key to stop the alarm.
3. Press the **[QUIT]** soft key to return to radio operation
4. Press the microphone's **PTT** switch and talk into the microphone to the other vessel.

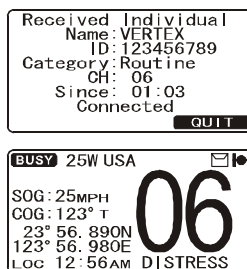

11.6 CALL WAITING DIRECTORY

The **GX2000/GX2100** logs received distress calls and individual calls. The DSC Call Waiting feature is similar to an answer machine where calls are recorded for review. When a call is logged while the radio is set on the DSC Standby function, a “☒” icon will appear on the display. The **GX2000/GX2100** can memorize up to the latest 26 Distress, and up to the latest 64 other calls (Individual, Group, All Ship etc.).

11.6.1 Enabling the Call Waiting Feature

Follow the steps below to enable or disable the Call Waiting feature.

1. Press and hold down the [CALL(MENU)] key until “Setup Menu” appears.
2. Rotate the CHANNEL knob to select “DSC SETUP” menu.
3. Press the [SELECT] soft key, then select “INDIVIDUAL ACK” with the CHANNEL knob.
4. Press the [SELECT] soft key.
5. Rotate the CHANNEL knob to select “ABLE TO COMPLY” or “UNABLE”.
6. Press the [ENT] soft key to store the selected setting.
7. Press the [QUIT] soft key several times to return to radio operation.

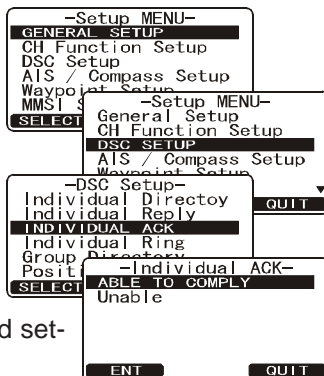

11.6.2 Reviewing Received Calls Logged into the Call Waiting Directory

1. Press the [CALL(MENU)] key. The “DSC Menu” will appear.
2. Rotate the CHANNEL knob to select “DSC LOG” menu.
3. Press the [SELECT] soft key, then rotate the CHANNEL knob to select the category (“DISTRESS LOG” or “OTHER CALL LOG”) you want to review and/or call back.
4. Press the [SELECT] soft key, then rotate the CHANNEL knob to select the station (name or MMSI number) you want to review and/or call back. When there is an unread received call, “☒” icon will appear behind the station name (or MMSI number).
5. Press the [SELECT] soft key, to review details for the selected station.
6. Press the [RELAY] soft key, to call the selected station.

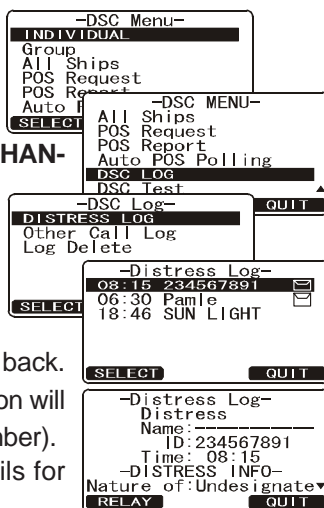

NOTE

When there is an unread received call, the category (“**DISTRESS LOG**” or “**OTHER CALL LOG**”) will blink.

11.6.3 Deleting a call from the “DSC LOG” directory

1. Press the [CALL(MENU)] key. The “DSC Menu” will appear.
2. Rotate the CHANNEL knob to select “DSC LOG” menu.
3. Press the [SELECT] soft key, then rotate the CHANNEL knob to select “LOG DELETE” menu.
4. Press the [SELECT] soft key, then rotate the CHANNEL knob to select the category (“DISTRESS LOG” or “OTHER CALL LOG”) to be deleted.
5. Press the CHANNEL knob.
 - 1) If you want to delete all stations at a time, select the “ALL LOG DELETE” with the CHANNEL knob, then press the [SELECT] soft key twice to delete the all stations log.
 - 2) If you want to delete one of the logged stations, select the “VIEW LOG LIST” with the CHANNEL knob, then press the [SELECT] soft key. Rotate the CHANNEL knob to select the station (name or MMSI number) to be deleted, then press the [DELETE] soft key. The display will show “Are your sure?” press the [OK] soft key.
6. Press the [QUIT] soft key several times to return to radio operation.

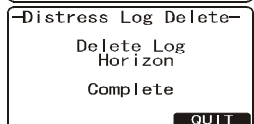
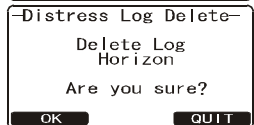
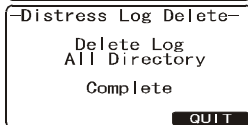
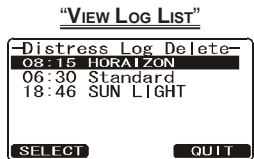
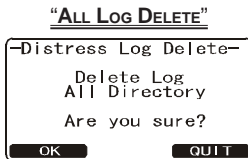
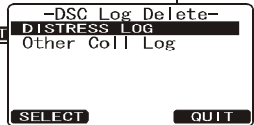
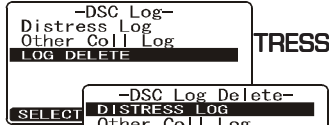

11.7 GROUP CALL

This feature allows the user to contact a group of specific vessels (example members of a yacht club) using DSC radios with Group call function to automatically switch to a desired channel for voice communications. This function is very useful for yacht clubs and vessels traveling together that want to collectively make announcements on a predetermined channel. Up to 32 Group MMSI may be programmed.

11.7.1 Setup a Group Call

For this function to operate the same Group MMSI must be programmed into all the DSC VHF radios within the group of vessels that will be using this feature. To understand Group MMSI programming, first a Ship MMSI has to be understood.

Ship MMSI: The first three digits called a MID (Mobile Identity Group) of a Ship MMSI denote the country the ship registered for a MMSI. The last 6 digits are specific to the Ships ID.

Ship MMSI Example: If your MMSI is “366123456”, “366” is MID which denote the country and “123456” is Ships ID for you.

Group MMSI:

- ❑ Group MMSI numbers are not assigned by the FCC or other organizations licensed to assign ship MMSI numbers.
 - ❑ The first digit of a Group MMSI is always set to “0” by International rules. All Standard Horizon radios are preset so when programming a Group MMSI the first digit is set to “0”.
 - ❑ The USCG recommends programming the MID of a ships MMSI into the Second, Third and Fourth digits of the Group MMSI as it denotes the area the ship is located in.
 - ❑ The last 5 digits are decided upon by persons in the Group. This is an important step as all radios in the Group must contain the same Group MMSI so they can be contacted by each other. There is a chance that another group of vessels may program in the same Group MMSI. If this happens, simply change one or more of the last 5 digits of the Group MMSI.
1. Press and hold down the [CALL(MENU)] key until “Setup Menu” appears.
 2. Rotate the CHANNEL knob to select “DSC SETUP” menu.
 3. Press the [SELECT] soft key, then select “GROUP DIRECTORY” with the CHANNEL knob.
 4. Press the [SELECT] soft key, then select “ADD” with the CHANNEL knob.

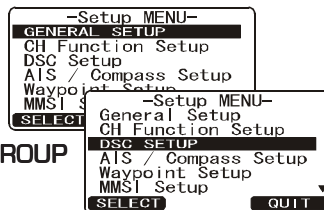

5. Press the **[SELECT]** soft key.
6. Rotate the **CHANNEL** knob to scroll through the first letter of the name of the group you want to reference in the directory.
7. Press the **[SELECT]** soft key to store the first letter in the name and step to the next letter to the right.
8. Repeat step 6 and 7 until the name is complete. The name can consist of up to eleven characters, if you do not use all eleven characters press the **[SELECT]** soft key to move to the next space. This method can also be used to enter a blank space in the name. If a mistake was made entering in the name repeat pressing the **[BACK]** soft key until the wrong character is selected, then rotate the **CHANNEL** knob to correct the entry.
9. After the eleventh letter or space has been entered, press and hold the **[SELECT]** soft key to advance to the GROUP MMSI (Maritime Mobile Service Identity Number) number entry.
10. Rotate the **CHANNEL** knob to select the second number of the MMSI (nine digits: first digit permanently set to "0") which you want to contact, then press the **[SELECT]** soft key to step to the next number. Repeat this procedure until all eight space of the MMSI number are entered.
11. If a mistake was made entering in the MMSI number repeat pressing the **[BACK]** soft key until the wrong number is selected, then rotate the **CHANNEL** knob to correct the entry.
12. To store the data entered, press and hold the **[SELECT]** soft key.
13. To enter another group address, repeat steps 5 through 12.
14. Press the **[QUIT]** soft key several times to return to radio operation.

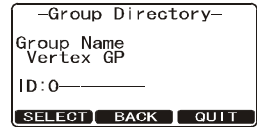
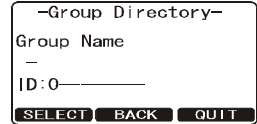
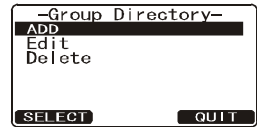

11.7.2 Transmitting a Group Call

Pre-Programmed Calling

1. Press the **[CALL(MENU)]** key. The "DSC Menu" will appear.
2. Rotate the **CHANNEL** knob to select "GROUP". (To cancel, press the **[QUIT]** key.)
3. Press the **[SELECT]** soft key. The transceiver will beep, and the "Last Group Call" will appear.
4. Rotate the **CHANNEL** knob to select the "Group" you want to contact.

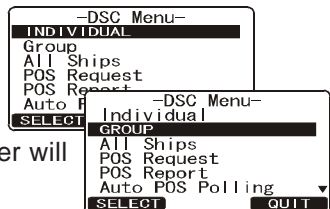

- Press the [**SELECT**] soft key, then rotate the **CHANNEL** knob to select the operating channel you want to communicate on, then press the [**SELECT**] soft key. If the channel you want is not shown, press the [**MANUAL**] soft key, then rotate the **CHANNEL** knob to select the operating channel you want to communicate on, then press the [**SELECT**] soft key.
- Press the [**SELECT**] soft key again to transmit the Group Call signal.
- When the Group Call signal is sent, the display will be as shown in the illustration at the right.
- After the Group Call is transmitted, all the radios in the group will switch to the designated channel.
- Listen to the channel to make sure it is not busy, then press the microphone's **PTT** switch and call the other vessel you desire to communicate with.

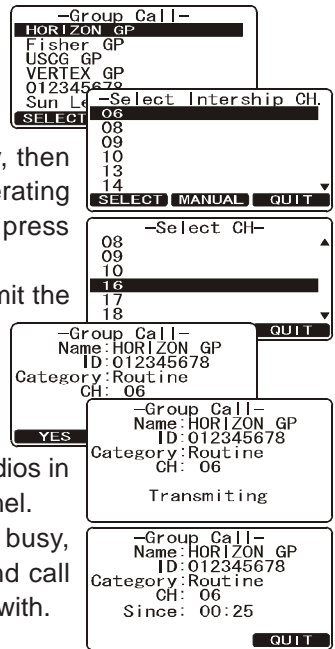

Manual Calling

This feature allows you to contact a group of vessels by entering in their Group MMSI manually.

- Press the [**CALL(MENU)**] key. The “**DSC Menu**” will appear.
- Rotate the **CHANNEL** knob to select “**GROUP**”. (To cancel, press the [**QUIT**] soft key.)
- Press the [**SELECT**] soft key. The transceiver will beep, and the “Last Group Call” will appear.
- Select “**MANUAL**” with the **CHANNEL** knob.
- Press the [**SELECT**] soft key.
- Rotate the **CHANNEL** knob to select the first number of the MMSI (nine digits: first digit permanently set to “0”) which you want to contact, then press the [**SELECT**] soft key to step to the next number.
- Repeat step 6 to set the MMSI number.
- If a mistake was made entering in the MMSI

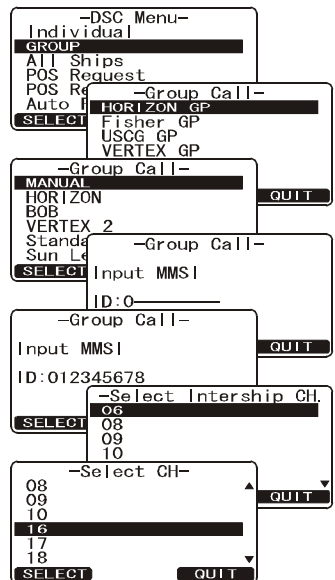

number, repeat pressing the **[BACK]** soft key until the wrong number is selected, then rotate the **CHANNEL** knob to correct the entry.

9. When finished entering the MMSI number, press and hold the **[SELECT]** soft key.
10. Rotate the **CHANNEL** knob to select the operating channel you want to communicate on, then press the **[SELECT]** soft key. If the channel you want is not shown, press the **[MANUAL]** soft key, then rotate the **CHANNEL** knob to select the operating channel you want to communicate on, then press the **[SELECT]** soft key.
11. Press the **[YES]** soft key to transmit the Group Call signal.
12. After the Group Call is transmitted, all the radios in the group will switch to the designated channel.
13. Listen to the channel to make sure it is not busy, then press the **PTT** button and talk into the microphone to the group of vessels.

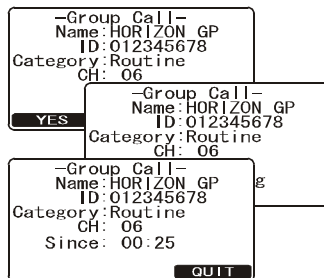

11.7.3 Receiving a Group Call

1. When a group call is received, the **GX2000/GX2100** will produce a ringing alarm sound.
2. The radio will automatically switch to the requested channel.
3. Press the **[QUIT]** soft key to stop the alarm.
4. Monitor the channel for the person calling the Group for a message.
5. If you want to respond, monitor the channel to make sure it is clear, then press the microphone's **PTT** switch and talk into the microphone to the group of vessels.
6. Press the **[QUIT]** soft key to return to radio operation.

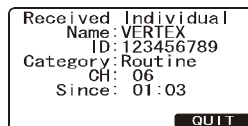

NOTE

After a Group call is received, the time the call was made and the ships MMSI or vessels name will appear on the display.

11.8 POSITION REQUEST

Advancements in DSC have made it possible to poll the location of another vessel and show the position of that vessel on the display of the **GX2000/GX2100**. Standard Horizon has taken this feature one step further, if any compatible GPS chart plotter is connected to the **GX2000/GX2100**, the polled position of the vessel is shown on the display of the GPS chart plotter making it easy to navigate to the location of the polled vessel. This is a great feature for anyone wanting to know the position of another vessel. For example your buddy that is catching fish, or finding the location of a person you are cruising with.

NOTE

The other vessel must have an operating GPS receiver connected to its DSC transceiver and must not have its transceiver set not to deny position requests. (Refer the section “**11.5 INDIVIDUAL CALL**” to enter information into the individual directory).

11.8.1 Setting up Position Reply

The **GX2000/GX2100** can be set up to automatically or manually send your position to another vessel. This selection is important if you are concerned about someone polling the position of your vessel that you may not want to. In the manual mode you will see the MMSI or persons name shown on the display allowing you to choose to send your position to the requesting vessel.

1. Press and hold down the **[CALL(MENU)]** key until “**Setup Menu**” appears.
2. Rotate the **CHANNEL** knob to select “**DSC SETUP**” menu.
3. Press the **[SELECT]** soft key, then select “**POSITION REPLY**” with the **CHANNEL** knob.
4. Press the **[SELECT]** soft key, then select “**AUTOMATIC**” or “**MANUAL**”. In “**AUTOMATIC**” mode, after a DSC POS Request is received, the radio will automatically transmit your vessels position. In “**MANUAL**” mode, the display of the **GX2000/GX2100** will show who is requesting the position and the **YES** soft key on radio has to be pressed to send your position to the requesting.
5. Press the **[SELECT]** soft key to store the selected setting.
6. Press the **[QUIT]** soft key several times to return to radio operation.

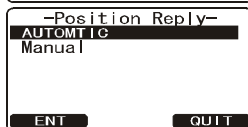
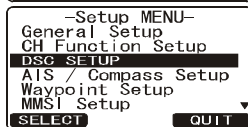
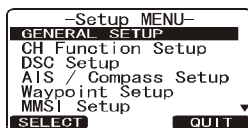

11.8.2 Transmitting a Position Request to Another Vessel

Pre-Programmed Request

1. Press the [CALL(MENU)] key. The “DSC Menu” will appear.
2. Rotate the **CHANNEL** knob to select “POS REQUEST”.
3. Press the [SELECT] soft key to show the “Last Individual Call”.
4. Rotate the **CHANNEL** knob to select a name, then press the [SELECT] soft key.
5. Press the [YES] soft key to transmit the Position Request DSC call.
6. When the **GX2000/GX2100** receives the position from the polled vessel it is shown on the radio display and also transferred to a GPS Chart plotter when connected.
7. Press the [QUIT] soft key to return to radio operation.

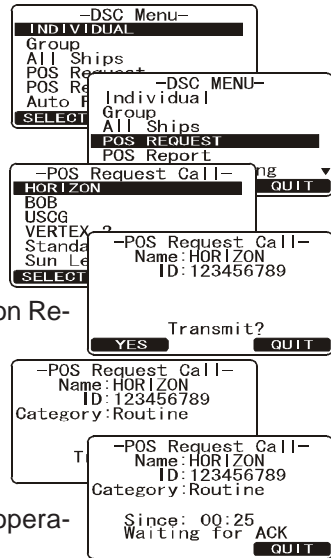

NOTE

If the **GX2000S/GX2100S** does not receive position data from the polled vessel, the display will show “NO POSITION DATA.”

Manual Request

This feature allows you to request the position of vessel by manually entering the MMSI of the ship you want to send your position to.

1. Press the [CALL(MENU)] key. The “DSC Menu” will appear.
2. Rotate the **CHANNEL** knob to select “POS REQUEST”.
3. Press the [SELECT] soft key to show the “Last Individual Call”.
4. Rotate the **CHANNEL** knob to select the “MANUAL,” then press the [SELECT] soft key.
5. Rotate the **CH** knob to select the first number of the MMSI (nine digits) which you want to contact, then press the [SELECT] soft key to step to the next number.
6. Repeat step 5 to set the MMSI number.
7. If a mistake was made entering in the MMSI

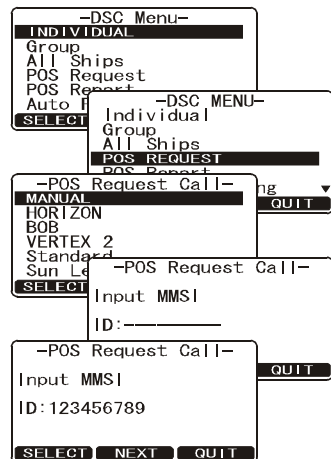

number, repeat pressing the [BACK] soft key until the wrong number is selected, then rotate the **CHANNEL** knob to correct the entry.

- When finished entering the MMSI number, press and hold the [SELECT] soft key.
- Press the [YES] soft key to transmit the position request DSC call.
- When the **GX2000/GX2100** receives the position from the polled vessel it is shown on the radio display and also transferred to the GPS Chart plotter.
- Press the [QUIT] soft key to return to radio operation.

```
-POS Request Call-
Name: HORIZON
ID: 123456789

Transmit?
YES QUIT
```

```
-POS Request Call-
Name: HORIZON
ID: 123456789
Category: Routine
Since: 00:25
Waiting for ACK
QUIT
```

11.8.3 Receiving a Position Request

When a position request call is received from another vessel, a ringing alarm sounds and POS REQUEST will be shown in the display. Operation and transceiver function differs depending on “Position Reply” in the “DSC Setup” menu setting discussed below:

Automatically reply:

- When a position request call is received, a calling alarm sounds 4 times. Then requested position coordinates are transmitted automatically to the vessel requesting your vessels position.
- To exit from position request display, press the [QUIT] soft key.

```
Received POS Request
Name: VERTEX
ID: 123456789
Category: Routine
Since: 01:03
QUIT
```

Manually reply:

- When a position request call is received from another vessel, the display will be as shown in the illustration at the right.
- A ringing alarm sounds 4 times. To send your vessels position to the requesting vessel, press the [REPLY] soft key. Or to exit from position request display, press the [QUIT] soft key.

```
Received POS Request
Name: VERTEX
ID: 123456789
Category: Routine
Since: 01:03
REPLY QUIT
```

```
POS Reply
Name: VERTEX
ID: 123456789
Category: Routine
Since: 01:03
Transmitted
QUIT
```

11.9 POSITION REPORT

The feature is similar to Position Request, however instead of requesting a position of another vessel this function allows you to send your position to another vessel. Your vessel must have an operating GPS receiver connected for the **GX2000/GX2100** to send the position.

NOTE

To transmit a Position Report Call, you must setup the **GX2000/GX2100** DSC Individual / Position Call Directory with the name of the vessel(s) or person and the MMSI of the DSC radio you wish to send your position to. To setup this directory refer to section “11.5.1 Setting up the Individual / Position Call Directory.”

11.9.1 Setting up a Position Report Ringer

The **GX2000/GX2100** has the capability to turn off the Position Send ringer.

1. Press and hold down the [CALL(MENU)] key until “Setup Menu” appears.
2. Rotate the CHANNEL knob to select “DSC SETUP” menu.
3. Press the [SELECT] soft key, then select “DSC BEEP” with the CHANNEL knob.
4. Press the [SELECT] soft key, then select “POS Report” with the CHANNEL knob.
5. Press the [ENT] soft key, then select “Off” with the CHANNEL knob.
6. Press the [ENT] soft key to store the selected setting.
7. Press the [QUIT] soft key several times to return to radio operation.

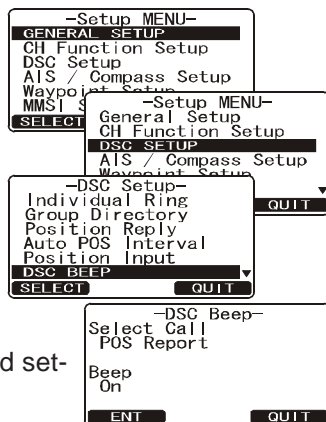

To re-enable the ringer tone, repeat the above procedure, rotating the CHANNEL knob to select “On” in step “5” above.

11.9.2 Transmitting a DSC Position Report Call

Pre-Programmed Calling

1. Press the [CALL(MENU)] key. The “DSC Menu” will appear.
2. Rotate the CHANNEL knob to select “POS REPORT”. (To cancel, press the [QUIT] soft key.)
3. Press the [SELECT] soft key. The transceiver will beep, and the “Last Individual Call” will appear.

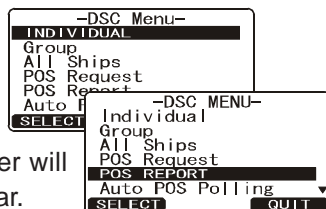

4. Rotate the **CHANNEL** knob to select the name in the directory, then press the [**SELECT**] soft key.
5. Press the [**YES**] soft key to send your position to the selected vessel.
6. Press the [**QUIT**] key to return to radio operation.

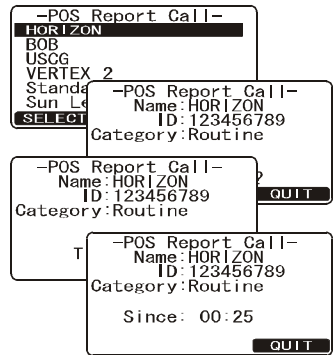

Manual Calling

This feature allows you to send your position to another vessel by manually entering the MMSI of the ship you want to send your position to.

1. Press the [**CALL(MENU)**] key. The “**DSC Menu**” will appear.
2. Rotate the **CHANNEL** knob to select “**POS REPORT**”. (To cancel, press the [**QUIT**] soft key.)
3. Press the [**SELECT**] soft key. The transceiver will beep, and the “Position Report Call” menu will appear.
4. Rotate the **CHANNEL** knob to select “**MANUAL**”, then press the [**SELECT**] soft key.
5. Rotate the **CHANNEL** knob to select the first number of the MMSI (nine digits: first digit permanently set to “0”) which you want to contact, then press the [**SELECT**] soft key to step to the next number.
6. Repeat step 5 to set the MMSI number.
7. If a mistake was made entering in the MMSI number, repeat pressing the [**BACK**] soft key until the wrong number is selected, then rotate the **CHANNEL** knob to correct the entry.
8. When finished entering the MMSI number, press and hold the Press the [**SELECT**] soft key.
9. Press the [**YES**] soft key to send your position to the selected vessel.
10. Press the [**CLR(WX)**] key to return to radio operation.

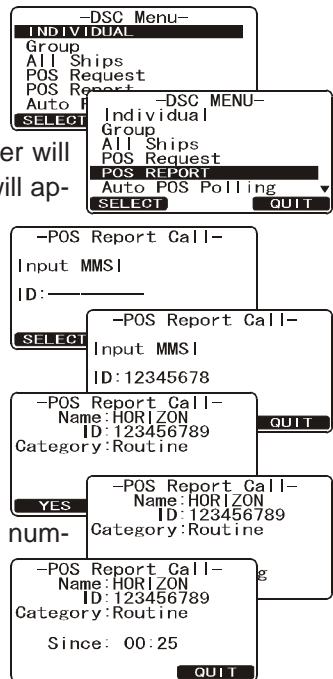

11.9.3 Receiving a DSC Position Report Call

When another vessel transmits their vessels location to the **GX2000/GX2100** the following will happen:

1. A ringing sound will be produced when the call is received.
2. Press the **[CLR(WX)]** key to stop ringing.
3. Rotate the **CHANNEL** knob to see position information of the station.
4. To exit to radio mode, press the **[QUIT]** soft key.



11.9.4 Navigating to a received Position Report call

1. If you wish to display the received vessel on the "WAYPOINT" screen, go to next step, if you wish to only save the received vessel, go to step 9, otherwise press the **[QUIT]** soft key to return to radio operation.
2. Press the **[TO WPT]** soft key to enter the "Waypoint Input" menu, then enter the desired waypoint name (up to 11 characteres), described previously (select the letter/number by rotating the **CHANNEL** knob and move the cursor by pressing the **[ENT]/[BACK]** soft key).
3. You may change the "ID", if desired.
4. When you are finished entering the waypoint name, press and hold the **[ENT]** soft key to show the "WAYPOINT" Screen. The display indicates the distance and direction of the received vessel, and also the compass indicates the received vessel by dot (●).
5. To stop navigation and return to the radio mode:
 - 1) Press and hold down the **[CALL(MENU)]** key until "Setup Menu" appears.
 - 2) Press the **[SELECT]** soft key, then select "GENERAL SETUP" with the **CHANNEL** knob.
 - 3) Press the **[SELECT]** soft key, then select "NORMAL" with the **CHANNEL** knob.
 - 4) Press the **[SELECT]** soft key to return to radio operation.

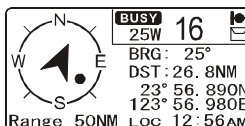
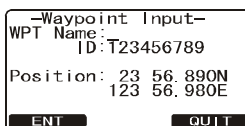

11.10 MANUAL INPUTTING OF THE GPS LOCATION (LAT/LON)

You may send the Latitude/Longitude of your vessel manually even if the **GX2000/GX2100** is not connected the GPS receiver unit.

After the position is entered, transmitting a DSC Distress, Position Request, or Position Send will contain the manually entered position.

1. Press and hold down the [**CALL(MENU)**] key until "Setup Menu" appears.
2. Rotate the **CHANNEL** knob to select "DSC SETUP" menu.
3. Press the [**SELECT**] soft key, then select "POSITION INPUT" with the **CHANNEL** knob.
4. Press the [**SELECT**] soft key. The transceiver will beep, and the display will be as shown in the illustration on the right.
5. Enter the latitude/longitude of your vessel and your local UTC time in the 24-hour notation by the **CHANNEL** knob. Rotate the **CHANNEL** knob to select the number and press the [**ENT**] soft key to move the cursor to the next character. You may backspace the cursor by pressing the [**BACK**] soft key, if you make a mistake.
6. To store the data entered, press and hold the [**ENT**] soft key.
7. Press the [**QUIT**] soft key several times to return to radio operation.

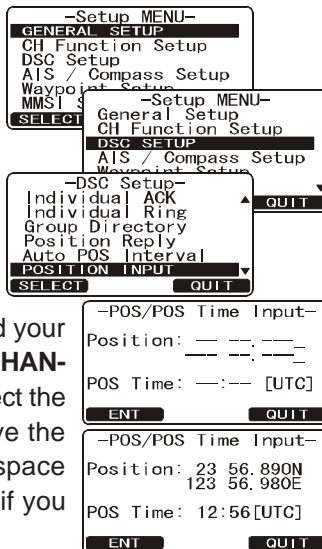

11.11 AUTO DSC POLLING

The **GX2000/GX2100** has the capability to automatically track four stations.

The following procedure allows the time interval between position requests to be setup.

1. Press and hold down the **[CALL(MENU)]** key until “**Setup Menu**” appears.
2. Rotate the **CHANNEL** knob to select “**DSC SETUP**” menu.
3. Press the **[SELECT]** soft key, then select “**AUTO DSC INTERVAL**” with the **CHANNEL** knob.
4. Rotate the **CHANNEL** knob to select the desired interval time (1,2,3,4,5,10,30 and 40 minutes) and press the **[ENT]** soft key.
5. Press the **[QUIT]** soft key numerous times to exit to the radio mode.

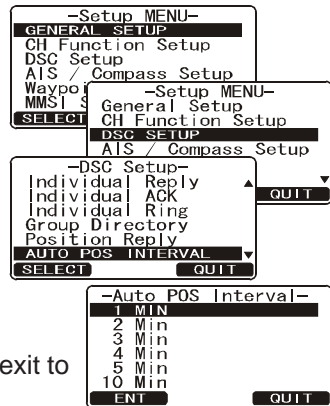

11.11.1 Selecting Stations to be Automatically Polled (tracked)

NOTE

The radio uses the Individual directory to select stations. Refer to section “**11.5.1 Setting up the Individual / Position Call Directory**” and to enter MMSI of stations you want to poll before proceeding.

1. Press the **[CALL(MENU)]** key. The “**DSC Menu**” will appear.
2. Rotate the **CHANNEL** knob to select “**AUTO POS POLLING**”, then press the **[SELECT]** soft key.
3. Rotate the **CHANNEL** knob to select the “**SELECT ADDRESS**”, then press the **[SELECT]** soft key.
4. The radio will show 4 calling stations to be selected, select “**CALL 1**” and press the **[SELECT]** soft key.
5. The radio will show the stations programmed in the Individual directory. Rotate the **CHANNEL** knob to select the desired station and press the **[SELECT]** soft key.
6. Repeat steps 4 and 5 for CALL 2, CALL 3 and CALL 4.

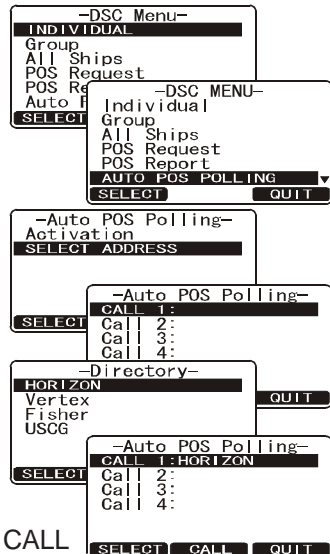

4 entries.

- When finished, press the [QUIT] soft key numerous times to exit to the radio mode.

11.11.2 Enable/Disable Auto DSC Polling

- Press the [CALL(MENU)] key. The “DSC Menu” will appear.
- Rotate the CHANNEL knob to select “AUTO POS POLLING”, then press the [SELECT] soft key.
- Rotate the CHANNEL knob to select the “ACTIVATION”, then press the [SELECT] soft key.
- Select “START” to enable transmissions to the stations or “STOP” to disable transmissions to stations.
- Press the [ENT] soft key.
- Press the [QUIT] soft key numerous times to exit to the radio mode.

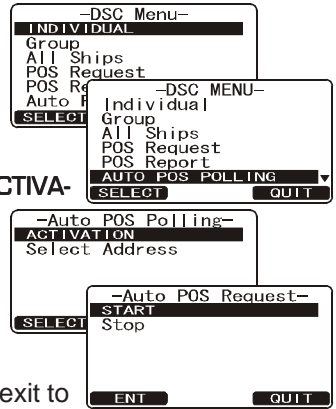

NOTE

When the radio receives position reports from a called vessel the display will show the image to the right and also output NMEA DSC and DSE sentences to a GPS Chart plotter.



12 RADIO SETUP

The optional **CMP30 (RAM3)** Remote Station Microphone can also change the SETUP menu using the following procedure.

12.1 DISPLAY

The **GX2000/GX2100** can select additional screens other than the default normal display by using the procedure below.

1. Press and hold down the **[CALL(MENU)]** key until "Setup Menu" appears, then select "GENERAL SETUP" with the **CHANNEL** knob.
2. Press the **[SELECT]** soft key, then rotate the **CHANNEL** knob to select "DISPLAY".
3. Press the **[SELECT]** soft key.
4. Rotate the **CHANNEL** knob to select desired screen type "NORMAL", "AIS", "COMPASS", or "WAYPOINT".
5. Press the **[SELECT]** soft key to store the selected setting.
6. Press the **[QUIT]** soft key several times to return to radio operation.

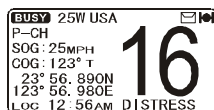
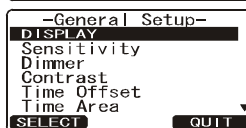
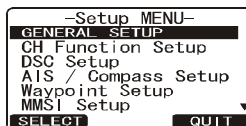

"NORMAL" DISPLAY

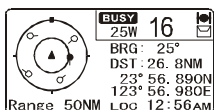

"AIS" DISPLAY

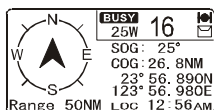

"COMPASS" DISPLAY

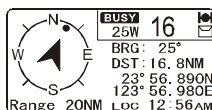

"WAYPOINT" DISPLAY

12.2 LOCAL DISTANCE RECEIVER ATTENUATOR

In some areas, signals from external sources may cause interference to receiving marine transmissions. The **GX2000/GX2100** has two selections, **DISTANCE** - used to receive weak signals (default), and **LOCAL** - which attenuates strong signals that may be interfering with reception.

1. Press and hold down the **[CALL(MENU)]** key until “**Setup Menu**” appears.
2. Rotate the **CHANNEL** knob to select “**GENERAL SETUP**” menu.
3. Press the **[SELECT]** soft key, then select “**SENSITIVITY**” with the **CHANNEL** knob.
4. Press the **[SELECT]** soft key.
5. Rotate the **CHANNEL** knob to select “**LOCAL**”. The receiver sensitivity is now reduced.
6. Press the **[ENT]** soft key to store the selected level.
7. Press the **[QUIT]** soft key several times to return to radio operation.

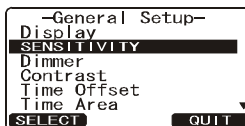
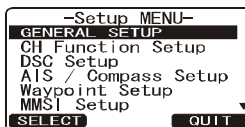

To return to normal sensitivity, repeat the above procedure, rotating the **CHANNEL** knob to select “**DISTANCE**” in step “5” above.

NOTE

In most cases, **DISTANCE** mode should be used. If **LOCAL** is selected, remember the setting should be changed to **DISTANCE** when navigating away from land.

12.3 LAMP ADJUSTING

This menu selection adjusts the backlight intensity.

1. Press and hold down the **[CALL(MENU)]** key until “**Setup Menu**” appears.
2. Rotate the **CHANNEL** knob to select “**GENERAL SETUP**” menu.
3. Press the **[SELECT]** soft key, then select “**DIMMER**” with the **CHANNEL** knob.
4. Press the **[SELECT]** soft key.
5. Rotate the **CHANNEL** knob to select the desired level. When “**OFF**” is selected, the lamp is turned off.
6. Press the **[ENT]** soft key to store the selected level.
7. Press the **[QUIT]** soft key several times to return to radio operation.

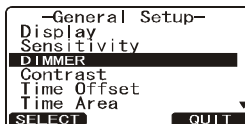
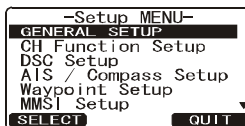

12.4 DISPLAY CONTRAST

Due to varying this selection sets up the display contrast for overhead or dash installations.

1. Press and hold down the [**CALL(MENU)**] key until “**Setup Menu**” appears.
2. Rotate the **CHANNEL** knob to select “**GENERAL SETUP**” menu.
3. Press the [**SELECT**] soft key, then select “**CONTRAST**” with the **CHANNEL** knob.
4. Press the [**SELECT**] soft key.
5. Rotate the **CHANNEL** selector knob to select the desired level. The contrast level can be set from “**0**” to “**31**.”
6. Press the [**ENT**] soft key to store the selected level.
7. Press the [**QUIT**] soft key several times to return to radio operation.

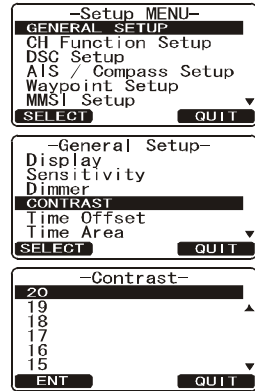

12.5 TIME OFFSET

Sets the time offset between local time (with inputted offset) and UTC (without time offset) shown on the display. Time is displayed only when an optional GPS Chart Plotter is connected.

1. Press and hold down the [CALL(MENU)] key until "Setup Menu" appears.
2. Rotate the CHANNEL knob to select "GENERAL SETUP" menu.
3. Press the [SELECT] soft key, then select "TIME OFFSET" with the CHANNEL knob.
4. Press the [SELECT] soft key.
5. Rotate the CHANNEL knob to select the time offset from UTC. See illustration below to find your offset time from UTC. If "00:00" is assigned, the time is the same as UTC (Universal Time Coordinated or GMT Greenwich Mean Time).
6. Press the [ENT] soft key to store the time offset.
7. Press the [QUIT] soft key several times to return to radio operation.

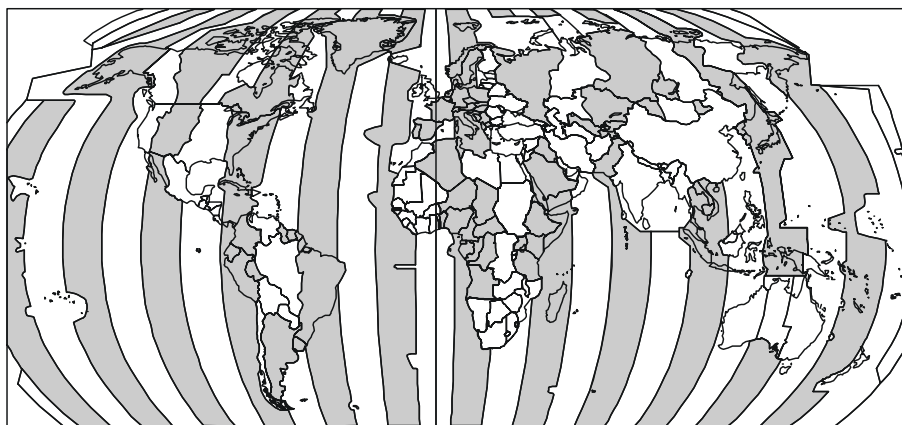
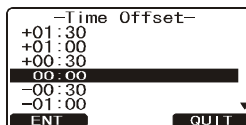
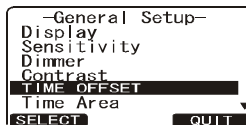
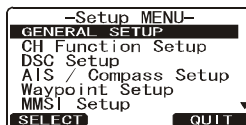

UTC/GMT
OFFSET TIME TABLE

12.6 TIME AREA

Allows the time shown on the display to be shown in local or UTC time. Time is displayed only when an optional GPS Chart Plotter is connected.

1. Press and hold down the **[CALL(MENU)]** key until "Setup Menu" appears, then select "GENERAL SETUP" with the **CH** knob.
2. Press the **[SELECT]** soft key, then rotate the **CHANNEL** knob to "TIME AREA".
3. Press the **CHANNEL** knob.
4. Rotate the **CHANNEL** knob to select "UTC" or "LOCAL".
5. Press the **[ENT]** soft key to store the selected setting.
6. Press the **[QUIT]** soft key several times to return to radio operation.

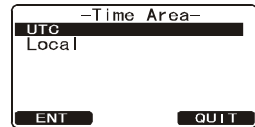
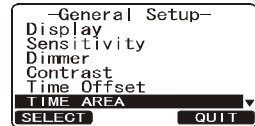
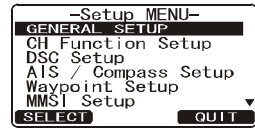

12.7 TIME DISPLAY

Set the radio show 12-hour format or 24-hour format of the clock.

1. Press and hold down the **[CALL(MENU)]** key until "Setup Menu" appears, then select "GENERAL SETUP" with the **CHANNEL** knob.
2. Press the **[SELECT]** soft key, then rotate the **CHANNEL** knob to select "TIME DISPLAY".
3. Press the **[SELECT]** soft key.
4. Rotate the **CHANNEL** knob to select "12 HOUR" or "24 HOUR".
5. Press the **[ENT]** soft key to store the selected setting.
6. Press the **[QUIT]** soft key several times to return to radio operation.

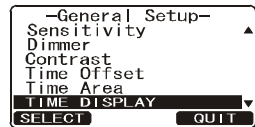
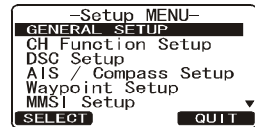

12.8 UNIT OF MEASURE

Allows Navigation and AIS display to be shown in “Knot”, “Mile/Hour” or “Kilo-Meter/Hour” (for speed) and “Nautical Mile” or “Kilo-Meter” (for distance).

NOTE

A GPS must be connected to the radio to be able to show SPEED and DISTANCE.

1. Press and hold down the [CALL(MENU)] key until “Setup Menu” appears, then select “GENERAL SETUP” with the CHANNEL knob.
2. Press the [SELECT] soft key, then rotate the CHANNEL knob to select “UNIT OF MEASURE”.
3. Press the [SELECT] soft key.
4. Rotate the CHANNEL knob to select “SPEED” or “DISTANCE” which you wish to change.
5. Press the [SELECT] soft key, then rotate the CHANNEL knob to select desired unit. Available selections are KTS (knot), MPH (Mile/Hour), or KMH (Kilo-Meter/Hour) for speed, and NH (Nautical Mile) or KM (Kilo-Meter) for distance.
6. Press the [ENT] soft key to store the selected setting.
7. Press the [QUIT] soft key several times to return to radio operation.

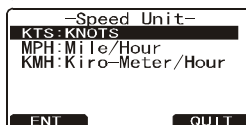
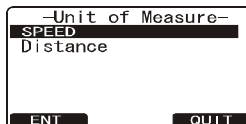
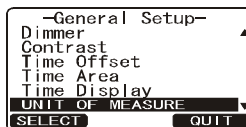
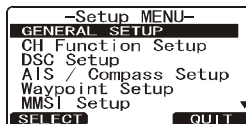

12.9 MAGNETIC

This selection allows customizing the GPS COG (Course Over Ground) displayed on the display to be in True or Magnetic.

NOTE

A GPS must be connected to the radio to be able to show COG.

1. Press and hold down the [CALL(MENU)] key until "Setup Menu" appears, then select "GENERAL SETUP" with the CHANNEL knob.
2. Press the [SELECT] soft key, then rotate the CHANNEL knob to "MAGNETIC".
3. Press the [SELECT] soft key.
4. Rotate the CHANNEL knob to select "TRUE" or "MAGNETIC".
5. Press the [ENT] soft key to store the selected setting.
6. Press the [QUIT] soft key several times to return to radio operation.

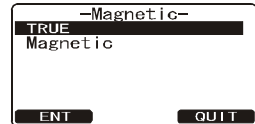
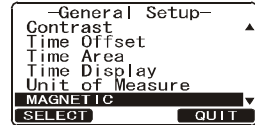
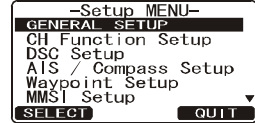

12.10 KEY BEEP

This selection is used to select the beep tone volume level when a key is pressed.

1. Press and hold down the [CALL(MENU)] key until "Setup Menu" appears, then select "GENERAL SETUP" with the CHANNEL knob.
2. Press the [SELECT] soft key, then rotate the CHANNEL knob to select "KEY BEEP".
3. Press the [SELECT] soft key.
4. Rotate the CHANNEL knob to select the desired level. The beep level can be set from "LEVEL 1" to "LEVEL 6", "HIGH", or "OFF".
5. Press the [ENT] soft key to store the selected level.
6. Press the [QUIT] soft several times to return to radio operation.

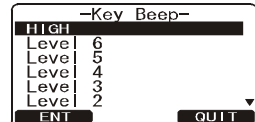
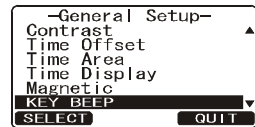
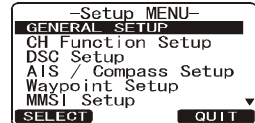

NOTE

Emergency alarm and beeps for DSC operation cannot be turned OFF.

12.11 FOG ALERT TONE FREQUENCY

The function allows the radio to be setup to send the proper fog frequency which is dependant on vessel size, shown below:

70 - 200Hz: Vessel that are 200 meters or more in length

130 - 350Hz: Vessel that are 75 Meters but less than 200 meters or more in length

250 - 525Hz: Vessel that are 66 Feet (20 Meters) but less than 247.5 Feet (75 Meters) in length

250 - 525Hz: Vessel that are 39.6 Feet (12 Meters) but less than 66 Feet (20 Meters) in length

1. Press and hold down the [CALL(MENU)] key until "Setup Menu" appears, then select "GENERAL SETUP" with the CHANNEL knob.
2. Press the [SELECT] soft key, then rotate the CHANNEL knob to select "FOG FREQ".
3. Press the [SELECT] soft key.
4. Rotate the CHANNEL knob to select the desired tone frequency.
5. Press the [ENT] soft key to store the selected setting.
6. Press the [QUIT] soft key several times to return to radio operation.

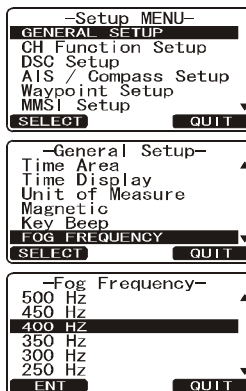

NOTE

By default the radio Fog frequency is set to 400Hz. In most cases this frequency should not be changed unless the vessel is very large.

12.12 SOFT KEY

This menu item allows selection of the number of soft keys, soft key selection and how long the display will show the soft key icon after a soft key is pressed.

1. Press and hold down the [CALL(MENU)] key until "Setup Menu" appears, then select "GENERAL SETUP" with the CHANNEL knob.
2. Press the [SELECT] soft key, then rotate the CHANNEL knob to "SOFT KEY".
3. Press the [SELECT] soft key, then rotate the CHANNEL knob to "NUMBER OF SOFT KEY".
4. Press the [SELECT] soft key, then rotate the CHANNEL knob to select the number of soft keys (3 through 10).
5. Press the [SELECT] soft key, then rotate the CH knob to "KEY ASSIGNMENT" (to change the use of selected soft keys).
6. Rotate the CHANNEL knob to select the [Soft] key, and press the [SELECT] soft key. Then, rotate the CHANNEL knob to select the new function to be assigned, and press the [SELECT] soft key. Available functions are listed below.
7. Press the [QUIT] key, then rotate the CHANNEL knob to select "KEY TIMER" (selects how long the soft key icon will be shown on the display after a soft key is pressed).
8. Press the [SELECT] soft key, then rotate the CHANNEL knob to select the time.
9. Press the [ENT] soft key to store the selected setting.
10. Press the [QUIT] soft key several times to return to radio operation.

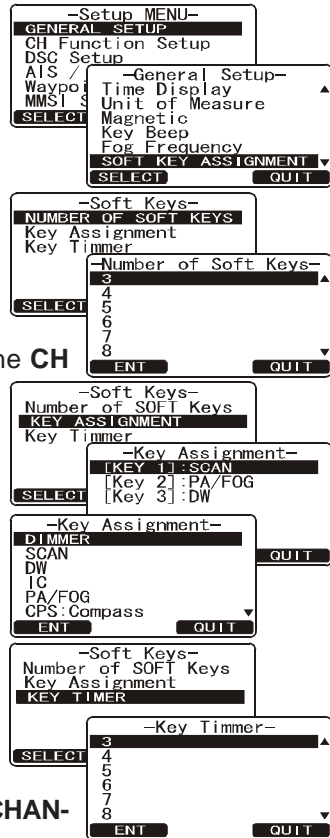

DISPLAY	FUNCTION
DIMMER	Select the menu for the display and key back light intensity
SCAN	Starts and stops Scanning.
DW	Starts and stops Dual Watch Scan.
IC	Activates Intercom between radio and RAM3 mic. (optional RAM3 required)
PA/FOG	Activates the PA / Fog Horn function.
CMP: COMPASS	Shows to the "Compass" display.
WPT	Shows to the "Waypoint" Navigation display.
AIS	Shows to the "AIS" display.
AIS AL	Toggles the AIS alarm "on" and "off".
PRESET	Programs or deletes the preset memory channel.
PSET 0 - PSET 9	Immediately recalls the preset memory channel.

12.13 CHANNEL GROUP

This section selects a channel group from USA, Canada, and International.

1. Press and hold down the [CALL(MENU)] key until "Setup Menu" appears.
2. Rotate the CHANNEL knob to select "CH FUNCTION SETUP".
3. Press the [SELECT] soft key, then rotate the CHANNEL knob to select "CH GROUP".
4. Press the [SELECT] soft key.
5. Rotate the CHANNEL knob to select desired channel group "USA", "INTL", or "CANADA".
6. Press the [ENT] soft key to store the selected setting.
7. Press the [QUIT] soft key several times to return to radio operation.

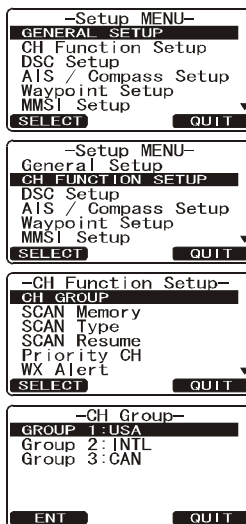

12.14 SCAN MEMORY

To be able to scan channels the radio must be programmed. This section allows channels to be stored in scan memory.

1. Press and hold down the [CALL(MENU)] key until "Setup Menu" appears.
2. Rotate the CHANNEL knob to select "CH FUNCTION SETUP".
3. Press the [SELECT] soft key, then rotate the CHANNEL knob to select "SCAN MEMORY".
4. Press the [SELECT] soft key.
5. Rotate the CHANNEL knob to select a desired channel to be scanned, then press the [ADD] key. "MEM" icon appears on the display, which indicates the channel has been selected to the scan channel.
6. Repeat step 5 for all the desired channels to be scanned.
7. To DELETE a channel from the list, select the channel then press the [DELETE] key. "MEM" icon disappears from the display.
8. When you have completed your selection, press the [QUIT] soft key several times to return to radio operation.

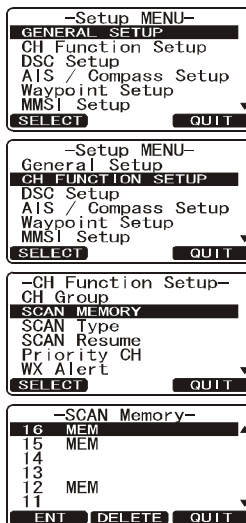

12.15 SCAN TYPE

This selection is used to select the scan mode between “Memory Scan” and “Priority Scan.”

1. Press and hold down the [CALL(MENU)] key until “Setup Menu” appears.
2. Rotate the CHANNEL knob to select “CH FUNCTION SETUP”.
3. Press the [SELECT] soft key, then select “SCAN TYPE” with the CHANNEL knob.
4. Press the [SELECT] soft key.
5. Rotate the CHANNEL knob to select “PRIORITY SCAN” or “MEMORY SCAN”.
6. Press the [ENT] soft key to store the selected setting.
7. Press the [QUIT] soft key several times to return to radio operation.

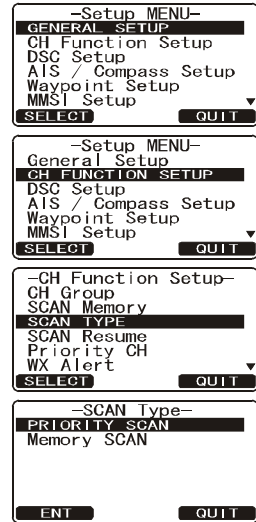

12.16 SCAN RESUME

This selection is used to select the time the GX2000/GX2100 waits after a transmission ends before the radio start to scan channels again.

1. Press and hold down the [CALL(MENU)] key until “Setup Menu” appears.
2. Rotate the CHANNEL knob to select “CH FUNCTION SETUP”.
3. Press the [SELECT] soft key, then select “SCAN RESUME” with the CHANNEL knob.
4. Press the [SELECT] soft key.
5. Rotate the CHANNEL knob to select the desired resume time. The resume time can be set to “1SEC” through “5SEC”, or “OFF”. In the “OFF” selection, the scanner will resume after the other station stops transmitting (carrier drops).
6. Press the [ENT] soft key to store the selected setting.
7. Press the [QUIT] soft key several times to return to radio operation.

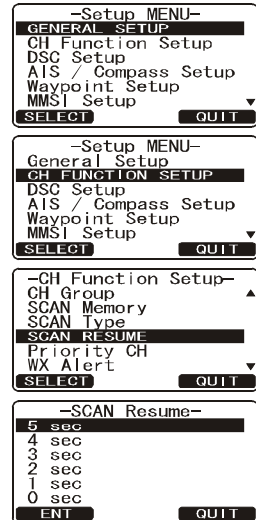

12.17 PRIORITY CHANNEL

By default the radio priority channel is set to channel 16. This procedure allows the radio to use a different priority channel used when priority scanning.

1. Press and hold down the [CALL(MENU)] key until "Setup Menu" appears.
2. Rotate the CHANNEL knob to select "CH FUNCTION SETUP".
3. Press the [SELECT] soft key, then select "PRIORITY CH" with the CHANNEL knob.
4. Press the [SELECT] soft key.
5. Rotate the CHANNEL knob to select the desired channel to be a priority.
6. Press the [ENT] soft key to store the selected setting.
7. Press the [QUIT] soft key several times to return to radio operation.

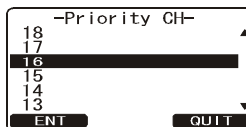
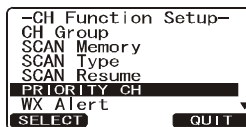
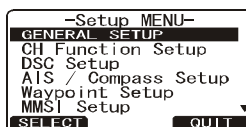

12.18 WEATER ALERT

This menu selection allows the WX Alert to be changed. The default setting is On Scan and WX channel.

1. Press and hold down the [CALL(MENU)] key until "Setup Menu" appears.
2. Rotate the CHANNEL knob to select "CH FUNCTION SETUP".
3. Press the [SELECT] soft key, then select "WX ALERT" with the CHANNEL knob.
4. Press the [SELECT] soft key.
5. Rotate the CHANNEL knob to select the desired WX alert mode. The WX alert mode can be set to "ON WX CH", "ON SCAN", "ON SCAN AND WX CH", or "OFF".
6. Press the [ENT] soft key to store the selected setting.
7. Press the [QUIT] soft key several times to return to radio operation.

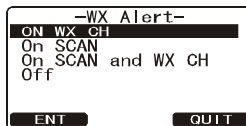
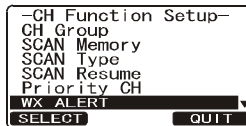
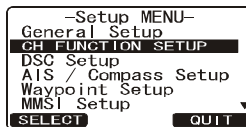
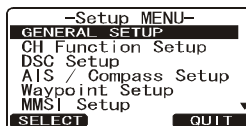

12.19 CHANNEL NAME

When radio mode (NORMAL) is selected, the display will show a name under the channel number. This name describes the use of the channel. The radio has the capability to customize the name by the procedure below.

Example: CH69 PLEASURE to HOOKUP

1. Press and hold down the [CALL(MENU)] key until "Setup Menu" appears.
2. Rotate the CHANNEL knob to select "CH FUNCTION SETUP".
3. Press the [SELECT] soft key, then select "CH NAME" with the CHANNEL knob.
4. Press the [SELECT] soft key.
5. Rotate the CHANNEL knob to select the channel to be named, then press the [ENT] soft key.
6. Rotate the CHANNEL knob to scroll through the first letter of the new channel name.
7. Press the [ENT] soft key to store the first letter in the name and step to the next letter to the right.
8. Repeat step 6 and 7 until the name is complete. The name can consist of up to 16 characters, if you do not use all 16 characters press the [ENT] soft key to move to the next space. This method can also be used to enter a blank space in the name. If a mistake was made entering in the name repeat pressing the [BACK] key until the wrong character is selected, then rotate the CHANNEL knob to correct the entry.
9. Press and hold the [ENT] soft key to save the name.
10. If you want to enter the name of another channel, repeat steps 5 through 9.
11. Press the [QUIT] soft key several times to return to radio operation.

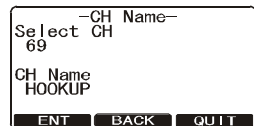
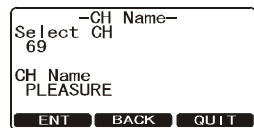
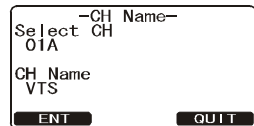
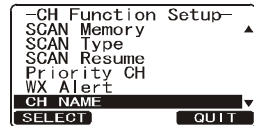
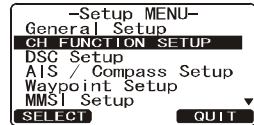
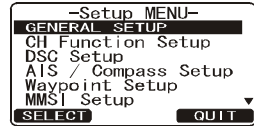

12.20 STATION NAME

This function allows you to change the name of the radio or second station microphone. Example: "Radio - Cabin", "RAM1 - Flybridge".

1. Press and hold down the [CALL(MENU)] key until "Setup Menu" appears.
2. Rotate the CHANNEL knob to select "CH FUNCTION SETUP".
3. Press the [SELECT] soft key, then select "STATION NAME" with the CHANNEL knob.
4. Press the [SELECT] soft key.
5. With the second station microphone connected, rotate the CHANNEL knob to select the Unit ("Radio" or "RAM1") to be named, then press the [ENT] soft key.
6. Rotate the CHANNEL knob to scroll through the first letter of the new channel name.
7. Press the [ENT] soft key to store the first letter in the name and step to the next letter to the right.
8. Repeat step 6 and 7 until the name is complete. The name can consist of up to 8 characters, if you do not use all 8 characters press the [ENT] soft key to move to the next space. This method can also be used to enter a blank space in the name. If a mistake was made entering in the name repeat pressing the [BACK] key until the wrong character is selected, then rotate the CHANNEL knob to correct the entry.
9. Press and hold the [ENT] soft key to enter the name.
10. If you want to enter the name of the connected RAM3 or Radio, repeat steps 5 through 9.
11. Press the [QUIT] soft key several times to return to radio operation.

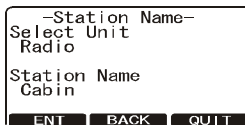
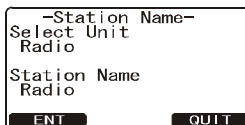
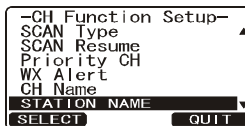
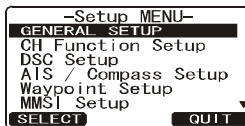

12.21 SCRAMBLER (Operates only when the optional **CVS2500** is installed)

NOTE

This menu will not appear unless a **CVS2500** is installed.

1. Press and hold down the [**CALL(MENU)**] key until “**Setup Menu**” appears.
2. Rotate the **CHANNEL** knob to select “**CH FUNCTION SETUP**”.
3. Press the [**SELECT**] soft key, then select “**SCRAMBLER**” with the **CHANNEL** knob.
4. Press the [**SELECT**] soft key.
5. Rotate the **CHANNEL** knob to select the channel to be scrambled and press the [**ENT**] soft key.
6. Rotate the **CHANNEL** knob to select the scrambler code. The scrambler code can be set from “**0**” to “**3**” and “**Off**”. When “**Off**” is selected the voice scrambler is disabled.
7. Press the [**ENT**] soft key to store the selected code.
8. Repeat steps 5 through 7 to set other channels.
9. Press the [**QUIT**] soft key several times to return to radio operation.

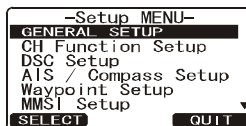

```
-Setup MENU-
GENERAL SETUP
CH Function Setup
DSC Setup
AIS / Compass Setup
Waypoint Setup
MMSI Setup
[SELECT] [QUIT]
```



```
-Setup MENU-
General Setup
CH FUNCTION SETUP
DSC Setup
AIS / Compass Setup
Waypoint Setup
MMSI Setup
[SELECT] [QUIT]
```

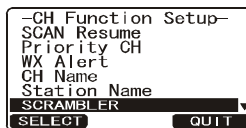

```
-CH Function Setup-
SCAN Resume
Priority CH
WX Alert
CH Name
Station Name
SCRAMBLER
[SELECT] [QUIT]
```

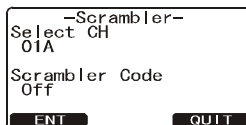

```
-Scrambler-
Select CH
01A
Scrambler Code
Off
[ENT] [QUIT]
```

13 AIS/COMPASS SETUP

13.1 Automatic Identification System (AIS)

The Automatic Identification System (AIS) is a short range coastal tracking system. AIS is intended to assist in collision avoidance by seeing positions and courses of AIS equipped vessels around your vessel.

AIS is mandatory on passenger ships, irrespective of size, all ships 300 gross tonnage and larger engaged on international voyages, cargo ships of 500 gross tonnage and larger not engaged on international voyages.

AIS uses two marine VHF channels. Each ship equipped with an AIS transponder transmits a packet every few seconds with information about the ship and its voyage. Radio frequencies: AIS1 = 161.975 MHz, or channel 87B and AIS2 162.025 MHz, or channel 88B. A stand-alone AIS receiver or the AIS receiver built in to a Class A or Class B transponder can pick up these radio signals and translate them into a NMEA data sentence that can be understood by a computer with the proper software or by an AIS-enabled chart plotter.

Classes of AIS:

Class A - 12.5W power output - mandated for use on SOLAS Chapter V vessels (and others in some countries).

Class B - 2W output - lower cost derivative for leisure and non-SOLAS markets.

The Matrix AIS **GX2100** is capable of receiving Class A and B transmission with the internal Dual Channel AIS receiver. The **GX2000** must be connected to an optional AIS receiver or transponder.

What is the range for AIS receivers?

- Since AIS uses similar VHF frequencies as a marine VHF radio, it has similar radio reception capabilities - which are basically line of sight. This means the higher your VHF antenna is mounted, the greater the reception area will be.
- Reception from Class A vessels that are 20 or even 30 miles away on open water is not uncommon as their antennas are mounted high off the water.
- Class B transponders use lower power for transmissions, therefore you can expect Class B vessels to be received when they are 5 to 10 miles away.

For additional information on AIS visit the USCG web site: <<http://www.navcen.uscg.gov/marcomms/ais.htm>>

13.2 DIRECTION

This function allows you to select the top of the AIS compass to be orientated in Course Up or North Up.

1. Press and hold down the [CALL(MENU)] key until "Setup Menu" appears.
2. Rotate the CHANNEL knob to select "AIS/COMPASS SETUP".
3. Press the [SELECT] soft key, then select "DIRECTION" with the CHANNEL knob.
4. Press the [SELECT] soft key.
5. Rotate the CHANNEL knob to select "NORTH UP" or "COURSE UP".
6. Press the [ENT] soft key to store the selected setting.
7. Press the [QUIT] soft key several times to return to radio operation.

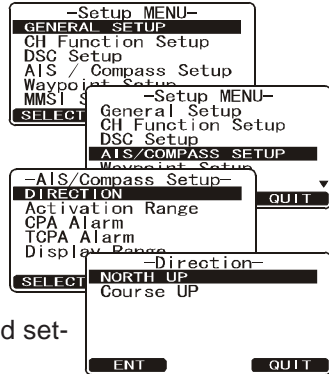

13.3 ACTIVATION RANGE

This function allows you to set the range the GX2100 AIS receiver, or GX2000 with AIS input searches for targets. The default setting is 10NM.

1. Press and hold down the [CALL(MENU)] key until "Setup Menu" appears.
2. Rotate the CHANNEL knob to select "AIS/COMPASS SETUP".
3. Press the [SELECT] soft key, then select "ACTIVATION RANGE" with the CHANNEL knob.
4. Press the [SELECT] soft key.
5. Rotate the CHANNEL knob to select the desired range.
6. Press the [ENT] soft key to store the selected setting.
7. Press the [QUIT] soft key several times to return to radio operation.

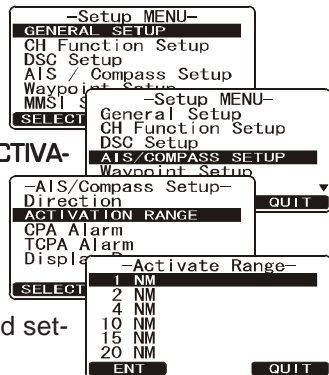

13.4 CPA ALARM

This function allows you to set the CPA (Closest Point of Approach)* function.

*: CPA means the positions at which two moving vessels reach their closest possible distance.

1. Press and hold down the [CALL(MENU)] key until "Setup Menu" appears.
2. Rotate the CHANNEL knob to select "AIS/COMPASS SETUP".
3. Press the [SELECT] soft key, then select "CPA ALARM" with the CHANNEL knob.
4. Press the [SELECT] soft key.
5. Rotate the CHANNEL knob to select the distance you would want the radio to alert you of an approaching AIS fitted vessel.
6. Press the [ENT] soft key, then rotate the CHANNEL knob to set the Alarm item to "On".
7. Press the [ENT] soft key to store the selected setting.
8. Press the [QUIT] soft key several times to return to radio operation.

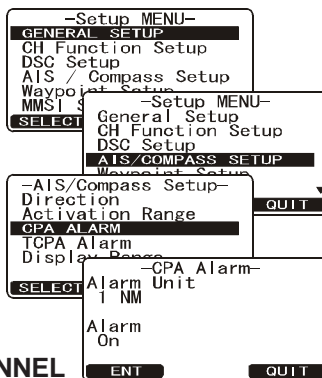

13.5 TCPA ALARM

This function allows you to set the TCPA (Time to Closest Point of Approach)* alarm.

*: Setting up a TCPA alarm sets a time point where the radio will alarm when an AIS equipped vessel approaching within the time selected.

1. Press and hold down the [CALL(MENU)] key until "Setup Menu" appears.
2. Rotate the CHANNEL knob to select "AIS/COMPASS SETUP".
3. Press the [SELECT] soft key, then select "DIRECTION" with the CHANNEL knob.
4. Press the [SELECT] soft key.
5. Rotate the CHANNEL knob to select the time that the TCPA alarm will sound.
6. Press the [ENT] soft key, then rotate the CHANNEL knob to set the Alarm item to "On".
7. Press the [ENT] soft key to store the selected setting.
8. Press the [QUIT] soft key several times to return to radio operation.

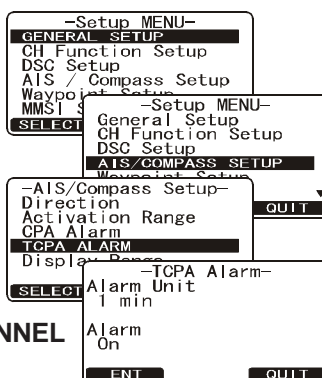

13.6 DISPLAY RANGE

The radio can show AIS targets on the display. This menu item allows setting of the range rings on the display. The default setting is 15NM.

1. Press and hold down the [CALL(MENU)] key until "Setup Menu" appears.
2. Rotate the CHANNEL knob to select "AIS/COMPASS SETUP".
3. Press the [SELECT] soft key, then select "DISPLAY RANGE" with the CHANNEL knob.
4. Press the [SELECT] soft key.
5. Rotate the CHANNEL knob to select select desired range. Available range selections are 0.5, 1.0, 2, 5, 10 and 15NM.
7. Press the [ENT] soft key to store the selected setting.
8. Press the [QUIT] soft key several times to return to radio operation.

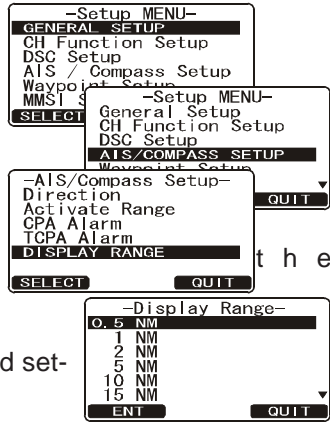

14 WAYPOINTS

The **GX2000/GX2100** is capable of storing up to 100 waypoint and navigating to them using the compass page.

In addition DSC distress calls with position or a position received from another DSC radio using DSC polling can be navigated to.

14.1 STORING WAYPOINTS

1. Press and hold down the **[CALL(MENU)]** key until “Setup Menu” appears.
2. Rotate the **CHANNEL** knob to select “WAYPOINT SETUP”.
3. Press the **[SELECT]** soft key, then select “WAYPOINT DIRECTORY” with the **CHANNEL** knob.
4. Press the **[SELECT]** soft key, then select “ADD” with the **CHANNEL** knob.
5. Press the **[SELECT]** soft key.
6. Enter the Waypoint Name, by rotating the **CHANNEL** knob to select the first letter.
7. Press the **[ENT]** soft key to store the first letter and to move to the second letter in the name.
8. Repeat step 5 and 6 until the name is shown. Press the **[ENT]** soft key to skip a letter if needed.
9. Enter the coordinates of the waypoint POSITION, by rotating the **CHANNEL** knob to select the first digit in the Latitude.
10. Press the Channel knob to skip the ID: entry and to the first digit of the latitude.
11. Press the **[ENT]** soft key to store the first number and to move to the second number in the position.
12. Repeat step 9 and 11 until the latitude is shown include N or S in the last digit.
13. Press the **[ENT]** soft key until the first digit of the Longitude is blinking.
14. Rotate the **CHANNEL** knob to select the first digit in the Longitude.
15. Press the **[ENT]** soft key to store the first number and to move to the second number in the position.
16. Repeat step 14 and 15 until the Latitude is shown include E or W in the last digit.
16. After all information is entered, press and hold the **[ENT]** soft key to store the waypoint into memory.

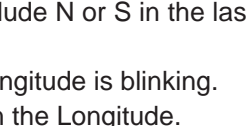
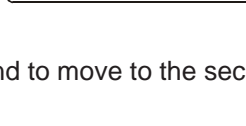
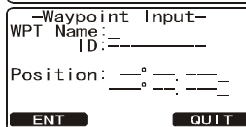
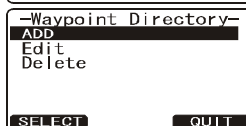
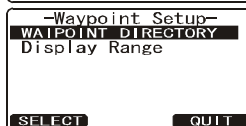
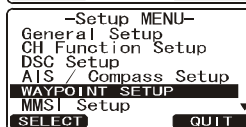
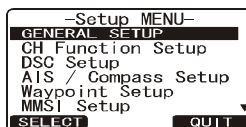

14.2 EDITING A WAYPOINT

This function allows a previously entered waypoint to be edited.

1. Press and hold down the [CALL(MENU)] key until "Setup Menu" appears.
2. Rotate the CHANNEL knob to select "WAYPOINT SETUP".
3. Press the [SELECT] soft key, then select "WAYPOINT DIRECTORY" with the CHANNEL knob.
4. Press the [SELECT] soft key, then select "EDIT" with the CHANNEL knob.
5. Rotate the CHANNEL knob to select the waypoint to be edited.
6. Press the [ENT] soft key to show the waypoint Input display.
7. Press the [ENT] soft key repeatedly until the number or letter is selected that is to be changed.
8. Rotate the CHANNEL knob to change the letter or number.
9. Repeat step 7 and 8 until the waypoint is updated.
10. Press and hold the [ENT] soft key to store the edited waypoint into memory.

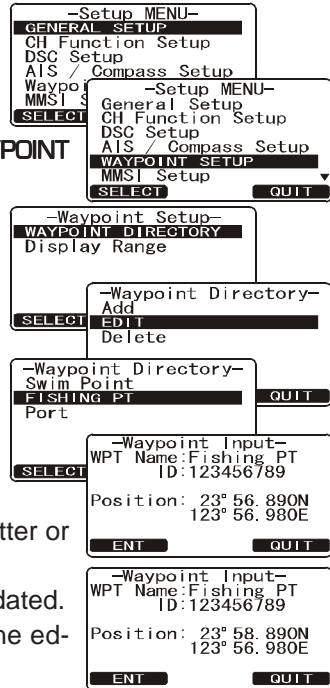

14.3 DELETING A WAYPOINT

1. Press and hold down the [CALL(MENU)] key until "Setup Menu" appears.
2. Rotate the CHANNEL knob to select "WAYPOINT SETUP".
3. Press the [SELECT] soft key, then select "WAYPOINT DIRECTORY" with the CHANNEL knob.
4. Press the [SELECT] soft key, then select "DELETE" with the CHANNEL knob.
5. Rotate the CHANNEL knob to highlight the waypoint to be deleted.
6. Press and hold the [ENT] soft key until the radio beeps and the waypoint directory is removed from the display.

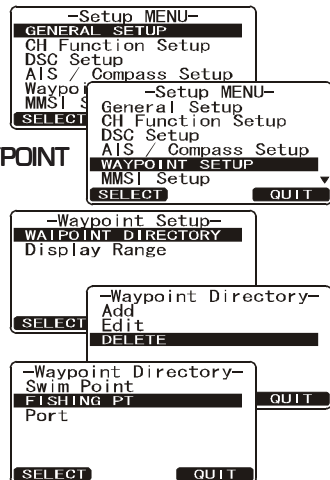

14.4 SAVING A DSC POSITION CALL AS A WAYPOINT

When a position is received from a another DSC radio the **GX2000/GX2100** allows the position to be saved as a waypoint.

1. After a position has been received, press the **[SAVE]** soft key.
2. The first digit in the WPT Name will be flashing, rotate the **CHANNEL** knob to the first letter of the name you want to input.
3. Press the **[ENT]** soft key, then rotate the **CHANNEL** knob to select the second letter in the name.
4. Repeat step 3 until the name is shown.
5. Press and hold the **[ENT]** soft key until the radio beeps.

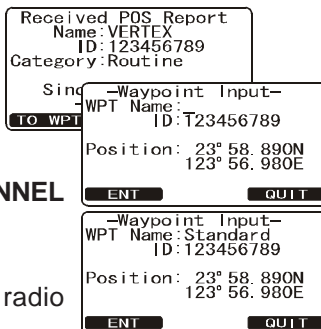

14.5 NAVIGATING TO A SAVED WAYPOINT

1. Press and hold down the **[CALL(MENU)]** key until "Setup Menu" appears.
2. Rotate the **CHANNEL** knob to select "GENERAL SETUP".
3. Press the **[SELECT]** soft key, then select "DISPLAY" with the **CHANNEL** knob.
4. Press the **[ENT]** soft key, and select "WAYPOINT", and press the **[SELECT]** soft key.
5. Select the waypoint name and press the **[ENT]** soft key to show the waypoint data display.
6. Press the **[ENT]** soft key to start navigating to the the waypoint and show the Waypoint Nav display.

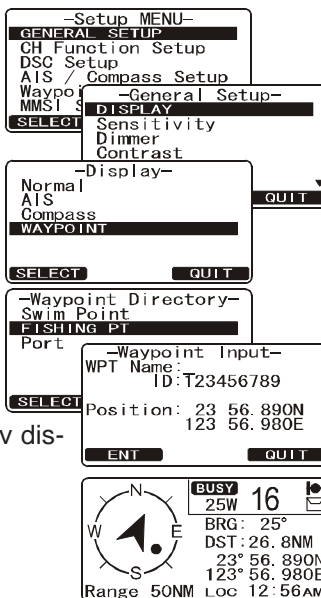

14.6 STOP NAVIGATING TO A WAYPOINT

To stop navigating to a waypoint, the radio must be switched to Normal Mode with the following procedure.

1. Press and hold down the [CALL(MENU)] key until "Setup Menu" appears.
2. Rotate the CHANNEL knob to select "GENERAL SETUP".
3. Press the [SELECT] soft key, then select "DISPLAY" with the CHANNEL knob.
4. Press the [ENT] soft key, and select "NORMAL", and press the [SELECT] soft key.

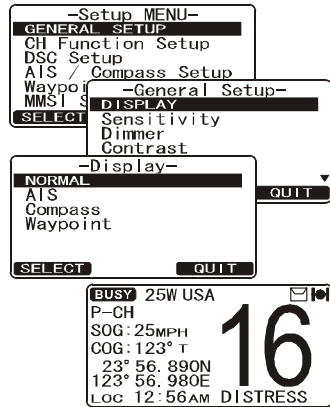

15 AIS OPERATION

The **GX2100** is equipped with an AIS (AUTOMATIC IDENTIFICATION SYSTEM) receiver and can display AIS targets around your vessel on the radios display. Therefore, you can identify and avoid other large vessels nearby your vessel.

The **GX2000** can also show AIS targets, however a separate AIS receiver or transponder with NMEA VDM 34800 baud must be connected to the accessory cable.

1. Press the **[AIS]** key to show the AIS screen. The AIS display shows your vessel as a triangle in the center of the display. AIS targets are shown as circles. The line projected from the circle is the AIS vessels course over ground (COG).

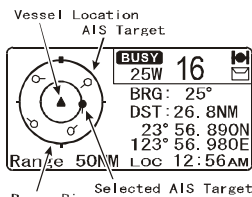

2. Press the one of the soft keys momentarily, then press the **[LIST]** soft key to show a list of AIS vessels being received.

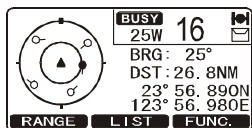

Note: Up to to 10 AIS targets can be shown on the display.

3. Rotate the **CHANNEL** knob to select the MMSI number (or vessel name). The selected AIS target is displayed with “●” icon, other station is displayed with “○” icon.



4. Press the one of the soft key momentarily, then press the **[INFO]** key to show more information of the AIS target.

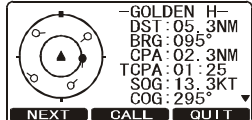

5. If you wish to contact (DSC Individual Call) the AIS ship:

- 1) Press the one of the soft keys momentarily, then press the **[CALL]** soft key.

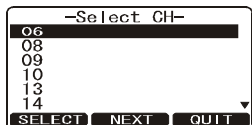

- 2) Rotate the **CHANNEL** knob to select the operating channel you want to communicate on and press the **CHANNEL** knob. If the channel you want is not shown, press the **[MANUAL]** soft key, then rotate the **CHANNEL** knob to select the operating channel you want to communicate on, then press the **CHANNEL** knob.

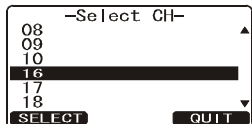

- 3) To transmit a Individual DSC call to the select AIS ship, press the **CHANNEL** knob again.

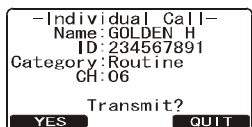

After the **GX2000** (when connected to an external AIS) or **GX2100** transmits, the radio wait for the DSC radio on the AIS ship to transmit an

reply, at which time the radio will ring like a telephone. Pick up the mic and press the **PTT** and hail the AIS vessel..

```

-Individual Call-
Name: HORIZON
ID: 234567891
Category: Routine
CH: 06
Since: 00:25
Waiting for ACK
QUIT
    
```

6. Press the **[QUIT]** key to return to AIS screen.
7. Press the **[AIS]** key to return to radio screen.

15.1 AIS RANGE

You may change the display range of the AIS screen. Press the one of the soft key momentarily, then press the **[RANGE]** key to display the range selection screen. Rotate the **CHANNEL** knob to select the desired range and press the **CHANNEL** knob to save the new range.

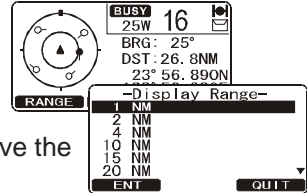

NOTE

You may change the display range unit of the AIS screen, refer to section "12.8 UNIT OF MEASURE".

16 ENHANCED RAM+ MIC OPERATION

When the Remote MIC is connected to the **GX2000/2100**, all VHF, DSC, setup menus, AIS, Waypoint, Compass functions and PA/Fog modes can be remotely operated. The **CMP30**'s operation is same as **GX2000/GX2100** except the receiver audio volume setting and squelch level setting. The reason for the same operation is to make the operation of the radio and **CMP30** mic easy. For specific operation of the **CMP30** mic review sections in the radio manual. The **CMP30** is supplied with 23 feet (7 m) of routing cable and can be extended up to 70 feet (21 m) using three 23-foot extension cables model **CT-100**. The Intercom feature can be used between the **CMP30** and the **GX2000/2100**. In addition, speaker wires are supplied at the panel mount of the routing cable for external speakers to be connected in noisy environments.

16.1 REMOTE MIC CONTROLS

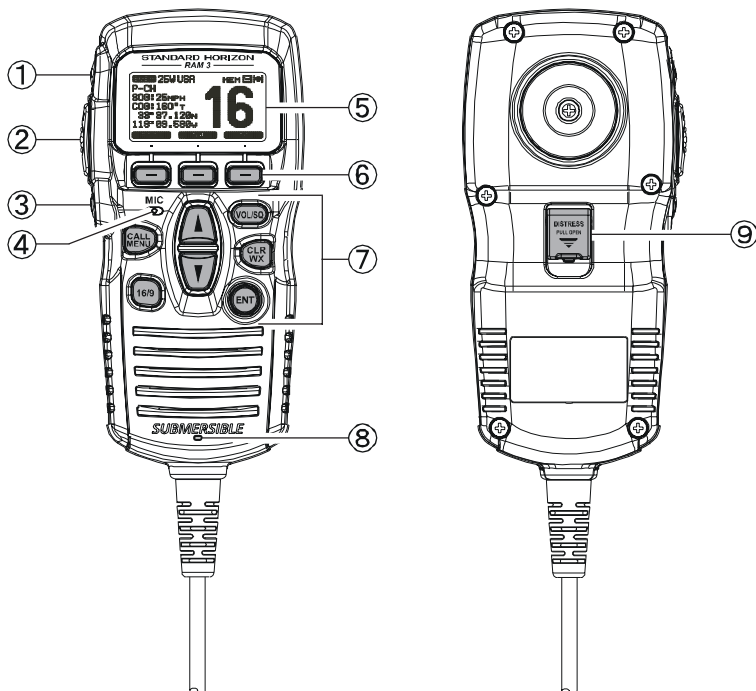

① [H/L] KEY

Toggles between high and low power. When the [H/L] key is pressed while the transceiver is on CH13 or CH67, the power is temporarily switched from LO to HI until the **PTT** switch is released. The [H/L] key does not function on transmit inhibited and low-power only channels.

② **PTT (Push-To-Talk) Key**

Push this key to enable the transmitter.

③ **POWER (⏻) Key**

Press and hold down this key to turn the transceiver and Remote MIC on or off.

④ **MICROPHONE**

The internal microphone is located here.

When transmitting, position your mouth about 1/2 to 1 inch (1.2 ~ 2.5 cm) away from the small mic hole. Speak slowly and clearly into the microphone.

⑤ **DISPLAY**

Channel display.

⑥ **SOFT KEY**

These three key's functions can be customized by the Setup Menu mode. When press one of these key briefly, the key functions will appear at the LCD bottom.

⑦ **KEY PAD**

[CALL/MENU] Key

Press this key to access the DSC OPERATION menu.

Press and hold this key to access the SETUP menu.

[16/9] Key

First press: channel 16 is immediately selected.

Second press: recalls the last selected channel.

Press and hold: selects channel 9.

[▲](UP)/[▼](DOWN) Key

These keys are used to select channels, adjust the volume and squelch level, and to choose DSC calls, DSC setup and Radio setup function.

[VOL/SQ] Key (Volume Control / Squelch Control)

First press: Volume adjustment mode

Second press: Squelch adjustment mode

First press: exits adjustment mode

When in volume or squelch mode, press the [▲] or [▼] keys to adjust the level.

[CLR/WX] Key

Press to CLEAR a function or menu selection. Press and hold to select NOAA Weather channels. Press and hold again to exit Weather mode and revert to radio mode.

Secondary use

Hold down the [16/9] key while pressing the [WX] key to change the mode from USA to International or Canadian.

[ENT] Key

This key functions as the enter key.

⑧ **SPEAKER**

The internal speaker is located here.

⑨ **[DISTRESS] KEY**

Used to send a DSC Distress call. Refer to section “11 DIGITAL SELECTIVE CALLING”.

17 MAINTENANCE

The inherent quality of the solid-state components used in this transceiver will provide many years of continuous use. Taking the following precautions will prevent damage to the transceiver.

- Keep the microphone connected or the jack covered at all times to prevent corrosion of electrical contacts;
- Never key the microphone unless an antenna or suitable dummy load is connected to the transceiver.
- Ensure that the supply voltage to the transceiver does not exceed 16 VDC or fall below 11 VDC.
- Use only STANDARD HORIZON-approved accessories and replacement parts.

In the unlikely event of serious problems, please contact your Dealer or our repair facility. Address and phone numbers for this facility, as well as warranty information, are contained in section “19 WARRANTY.”

17.1 REPLACEMENT PARTS

Occasionally an owner needs a replacement mounting bracket or knob. These can be ordered from our Parts Department by writing or calling:

Marine Division of Vertex Standard

US Headquarters

10900 Walker Street, Cypress, CA 90630, U.S.A.

Telephone (714) 827-7600

Commonly requested parts, and their part numbers are listed below.

- **Power Cord:** T9025406
- **VOL and SQL Knob:** RA1168000 (White), RA1168100 (Black)
- **CH Knob:** RA1167800 (White), RA1167900 (Black)
- **Mounting Bracket:** RA078410A (White), RA078400A (Black)
- **Mounting Bracket Knob:** RA0978500 (White), RA0978600 (Black)
- **Microphone Hanger:** RA0436000 (White), RA0458800 (Black)
- **RAM+ Mic Routing Cable Assembly:** S8101512

17.2 FACTORY SERVICE

In the unlikely event that the radio fails to perform or needs servicing, please contact the following:

Standard Horizon

Attention Marine Repair Department

10900 Walker Street, Cypress, CA 90630

Telephone (800) 366-4566

An “RA” Return Authorization number is not necessary to send a product in for service. Include a brief note describing the problem along with your name, return address, phone number, and proof of purchase.

17.3 TROUBLESHOOTING CHART

SYMPTOM	PROBABLE CAUSE	REMEDY
Transceiver fails to power up.	No DC voltage to the transceiver, or blown fuse.	a. Check the 12VDC battery connections and the fuse. b. The VOL/PWR knob needs to be pressed and held to turn the radio on.
Transceiver blows fuse when connected to power supply.	Reversed power wires.	Check the power cable for DC voltage, or replace the fuse (6A 250V). Make sure the red wire is connected to the positive (+) battery post, and the black wire is connected to the negative (-) battery post. If the fuse still blows, contact your Dealer.
Popping or whining noise from the speaker while engine runs.	Engine noise.	Reroute the DC power cables away from the engine. Add noise suppressor on power cable. Change to resistive spark plug wires and/or add an alternator whine filter.
Sound is not emitted from the internal or external speaker.	Accessory cable.	Check the connections of the accessory cable (Short Circuit the External speaker cable WHITE/SHIELD).
Sound is not emitted from the PA speaker.	Accessory cable.	Check the accessory cable connection (Short Circuit the PA speaker cable RED/SHIELD).
Receiving station reports low transmit power, even with transceiver set to HI power.	Antenna.	Have the antenna checked or test the transceiver with another antenna. If the problem persists, contact your Dealer for servicing.
"HI BATTERY" or "LO BATTERY" message appears when the power is turned on.	The power supply voltage is too high or too low.	Confirm that the connected power supply voltage is not 17 volts or lower than 10 volts.
"AIS" information is not displayed (GX2000).	Accessory cable.	Check the accessory cable connection (Short Circuit the NMEA-HS(+) cable BROWN and NMEA-COMMON (-) cable GREEN). Check the baud rate setting of the AIS receiver is 38400 baud.
Your position is not displayed.	Accessory cable.	Check the accessory cable connection. Some GPS use the battery ground line for NMEA connection.
	Setting of the GPS navigation receiver.	Check the output signal format of the GPS navigation receiver. This radio requires NMEA0183 format with GLL, RMB, or RMC sentence as an output signal. If the GPS has a baud rate setting make sure to select 4800 and parity to NONE.

18 CHANNEL ASSIGNMENTS

Tables on the following columns list the VHF Marine Channel assignments for U.S.A. and International use. Below are listed some data about the charts.

1. VTS. Where indicated, these channels are part of the U.S. Coast Guard's **Vessel Traffic System**.
2. Alpha channel numbers, that is, channel numbers followed by the letter A (such as Channel 07**A**) are **simplex** channels on the U.S.A. or Canadian channel assignments whose counterparts in the International assignments are **duplex** channels. International channels do not use "alpha" numbers. If you call the Coast Guard on Channel 16, they will sometimes ask you to "**go to channel 22 Alpha**." This is a channel assigned to U.S.A., and Canadian Coast Guards for handling distress and other calls. If your radio is set for **International** operation you will go to Channel 22 instead of 22**A**, and will not be able to communicate with the Coast Guard. To use Channel 22**A**, your radio must be set for **USA** or **Canada** operation, usually by a U/I/C (USA/International/Canada) control or combination of controls. Channel 22 (without an "A") is an **International** duplex channel for port operations. Some radios indicate an "A" adjacent to the alpha channels on the display; on others "alpha" is not indicated but the proper channel is selected based on the U/I/C setting.
3. Bridge-to-Bridge channels (for example, Channel 13) are for use by bridge operators on intercoastal waterways and rivers. It is also used by marine vessels in the vicinity of these bridges for navigation and for communicating with the bridge operators. Note that a limit of 1 Watt is specified for these channels. See page 17 for additional information.
4. The **S/D** column on the chart indicates either S (simplex) or D (duplex). **Simplex** means transmitting and receiving on the same frequency. Only one party at a time can talk, unlike a telephone. Be sure to say "**over**" and release your microphone push-to-talk switch at the end of each transmission. **Duplex** operation involves the use of one frequency for transmitting and a separate frequency for receiving. On channels specified as duplex on the charts, correct mode of operation is established automatically by your radio when you select a channel; you cannot change the mode. And you still must release the push-to-talk switch after each transmission in order to listen to the radio.
5. Channels normally used by recreational boaters are those that include the term "non-commercial" in the **Channel Use** column of the chart. Some of these are shared with other users and some are used only in certain geographic regions.
6. Marine vessels equipped with VHF radios are required to monitor Channel 16.

VHF MARINE CHANNEL CHART							
CH	U	C	I	S/D	TX	RX	CHANNEL USE
01		X	X	D	156.050	160.650	Public Correspondence (Marine Operator)
01A	X			S	156.050		Port Operation and Commercial. VTS in selected areas
02		X	X	D	156.100	160.700	Public Correspondence (Marine Operator)
03		X	X	D	156.150	160.750	Public Correspondence (Marine Operator)
03A	X			S	156.150		U.S. Government Only, Coast Guard
04			X	D	156.200	160.800	Public Correspondence (Marine Operator), Port operation, ship movement
04A		X		S	156.200		Pacific coast: Coast Guard, East Coast: Commercial fishing
05			X	D	156.250	160.850	Public Correspondence (Marine Operator), Port operation, ship movement
05A	X	X		S	156.250		Port operation. VTS in Seattle
06	X	X	X	S	156.300		Inter-ship Safety
07			X	D	156.350	160.950	Public Correspondence (Marine Operator), Port operation, ship movement
07A	X	X		S	156.350		Commercial
08	X	X	X	S	156.400		Commercial (Inter-ship only)
09	X	X	X	S	156.450		Boater Calling channel, Commercial & Non-commercial (Recreational)
10	X	X	X	S	156.500		Commercial
11	X	X	X	S	156.550		Commercial. VTS in selected areas.
12	X	X	X	S	156.600		Port operation. VTS in selected areas.
13	X	X	X	S	156.650		Inter-ship Navigation Safety (Bridge-to-bridge)
14	X	X	X	S	156.700		Port operation. VTS in selected areas.
15	X			S	---	156.750	Environmental (Receive only)
15		X	X	S	156.750		Commercial, non-commercial, ship movement (1 W)
16	X	X	X	S	156.800		International Distress, Safety and Calling
17	X	X	X	S	156.850		State Controlled (1 W)
18			X	D	156.900	161.500	Port operation, ship movement
18A	X	X		S	156.900		Commercial
19			X	D	156.950	161.550	Port operation, ship movement
19A	X			S	156.950		US: Commercial
19A		X		S	156.950		Coast Guard
20	X	X	X	D	157.000	161.600	Canadian Coast Guard Only, International: port operations and shipment
20A	X			S	157.000		Port operation
21			X	D	157.050	161.650	Port operation, ship movement
21A	X	X		S	157.050		U.S. Government Only, Canadian Coast Guard
22			X	D	157.100	161.700	Port operation, ship movement
22A	X	X		S	157.100		US and Canadian Coast Guard Liaison and Maritime Safety Information Broadcasts announced on channel 16
23		X	X	D	157.150	161.750	Public Correspondence (Marine Operator)
23A	X			S	157.150		U.S. Government Only
24	X	X	X	D	157.200	161.800	Public Correspondence (Marine Operator)
25	X	X	X	D	157.250	161.850	Public Correspondence (Marine Operator)
26	X	X	X	D	157.300	161.900	Public Correspondence (Marine Operator)
27	X	X	X	D	157.350	161.950	Public Correspondence (Marine Operator)
28	X	X	X	D	157.400	162.000	Public Correspondence (Marine Operator)

VHF MARINE CHANNEL CHART							
CH	U	C	I	S/D	TX	RX	CHANNEL USE
60		X	X	D	156.025	160.625	Public Correspondence (Marine Operator)
61			X	D	156.075	160.675	Public Correspondence (Marine Operator), Port operation, ship movement
61A	X	X		S	156.075		Public Coast: Coast Guard; East Coast: commercial fishing only
62			X	D	156.125	160.725	Public Correspondence (Marine Operator), Port operation, ship movement
62A		X		S	156.125		Public Coast: Coast Guard; East Coast: commercial fishing only
63			X	D	156.175	160.775	Public Correspondence (Marine Operator), Port operation, ship movement
63A	X	X		S	156.175		Port Operation and Commercial. VTS in selected areas.
64		X	X	D	156.225	160.825	Public Correspondence (Marine Operator), Port operation, ship movement
64A	X	X		S	156.225		Public Correspondence (Marine Operator), Port operation, ship movement
65			X	D	156.275	160.875	Public Correspondence (Marine Operator), Port operation, ship movement
65A	X	X		S	156.275		Port Operations
66			X	D	156.325	160.925	Public Correspondence (Marine Operator), Port operation, ship movement
66A	X	X		S	156.325		Port Operations
67	X	X	X	S	156.375		US: Commercial. Used for Bridge-to-bridge com- muni-cations in lower Mississippi River. Inter-ship only, Canada: Commercial fishing, S&R
68	X	X	X	S	156.425		Non-commercial (Recreational)
69	X	X	X	S	156.475		US: Non-commercial (Recreational), Canada: Commercial fishing only, International: Inter-ship, Port operations and Ship movement
70	X	X	X	S	156.525		Digital selective calling (voice communications not allowed)
71	X	X	X	S	156.575		US, Canada: Non-commercial (Recreational), International: Port operations and Ship movement
72	X	X	X	S	156.625		Non-commercial (Inter-ship only)
73	X	X	X	S	156.675		US: Port Operations, Canada: Commercial fish ing only, International: Inter-ship, Port operations and Ship movement
74	X	X	X	S	156.725		US: Port Operations, Canada: Commercial fishing only, International: Inter-ship, Port operations and Ship movement
75	X	X	X	S	156.775		Port Operations (Inter-ship only) (1W)
76	X	X	X	S	156.825		Port Operations (Inter-ship only) (1W)
77	X	X		S	156.875		Port Operations (Inter-ship only) (1W)
77			X	S	156.875		Port Operations (Inter-ship only)
78			X	D	156.925	161.525	Public Correspondence (Marine Operator), Port operation, ship-movement
78A	X	X		S	156.925		Non-commercial (Recreational)
79			X	D	156.975	161.575	Port operation and Ship movement
79A	X	X		S	156.975		Commercial

VHF MARINE CHANNEL CHART							
CH	U	C	I	S/D	TX	RX	CHANNEL USE
80			X	D	157.025	161.625	Port operation, ship movement
80A	X	X		S	157.025		Commercial
81			X	D	157.075	161.675	Port operation, ship movement
81A	X			S	157.075		U.S. Government Only - Environmental protection operations.
81A		X		S	157.075		Canadian Coast Guard Only
82			X	D	157.125	161.725	Public Correspondence (Marine Operator), Port operation, ship movement
82A	X	X		S	157.125		U.S. Government Only, Canadian Coast Guard Only
83		X		D	157.175	161.775	Canadian Coast Guard Only
83			X	D	157.175	161.775	Public Correspondence (Marine Operator)
83A	X	X		S	157.175		U.S. Government Only, Canadian Coast Guard Only
84	X	X	X	D	157.225	161.825	Public Correspondence (Marine Operator)
85	X	X	X	D	157.275	161.875	Public Correspondence (Marine Operator)
86	X	X	X	D	157.325	161.925	Public Correspondence (Marine Operator)
87		X	X	S	157.375		Port operation, ship movement
87A	X			S	157.375		Public Correspondence (Marine Operator)
88		X	X	S	157.425		Port operation, ship movement
88A	X			S	157.425		Commercial, Inter-ship Only
WX01	X	X	X	D	---	162.550	Weather (receive only)
WX02	X	X	X	D	---	162.400	Weather (receive only)
WX03	X	X	X	D	---	162.475	Weather (receive only)
WX04	X	X	X	D	---	162.425	Weather (receive only)
WX05	X	X	X	D	---	162.450	Weather (receive only)
WX06	X	X	X	D	---	162.500	Weather (receive only)
WX07	X	X	X	D	---	162.525	Weather (receive only)
WX08	X	X	X	D	---	161.650	Weather (receive only)
WX09	X	X	X	D	---	161.775	Weather (receive only)
WX10	X	X	X	D	---	163.275	Weather (receive only)

NOTE: Simplex channels, 3A, 21A, 23A, 61A, 64A, 81A, 82A and 83A CANNOT be lawfully used by the general public in U.S.A. waters.

Channel designator	Carrier frequency (MHz)		Points of communication (Intership and between coast and ship unless otherwise indicated)	
	Ship transmit	Coast transmit		
Port Operations				
01A ¹	156.050	156.050	Intership only.	
63A ¹	156.175	156.175		
05 ²	156.250	156.250		
65A	156.275	156.275		
66A	156.325	156.325		
12 ³	156.600	156.600		
73	156.675	156.675		
14 ³	156.700	156.700		
74	156.725	156.725		
77 ⁴	156.875			
20	157.000	161.600		
20A ¹²	157.000			
Navigational (Bridge-to-Bridge)⁵				
13 ⁶	156.650	156.650		
67 ⁷	156.375	156.375		
Commercial				
01A ¹	156.050	156.050	Intership only. Do.	
63A ¹	156.175	156.175		
07A	156.350	156.350		
67 ⁷	156.375			
08	156.400		
09	156.450	156.450		
10	156.500	156.500		
11 ³	156.550	156.550		
18A	156.900	156.900		
19A	156.950	156.950		
79A	156.975	156.975		
80A	157.025	157.025		
88A ⁸	157.425		
72 ¹⁴	156.625		
Digital Selective Calling				
70 ¹⁵	156.525	156.525		

Channel designator	Carrier frequency (MHz)		Points of communication (Intership and between coast and ship unless otherwise indicated)
	Ship transmit	Coast transmit	
Noncommercial			
68 ¹⁷	156.425	156.425	Intership only. Great Lakes only. Do. Internship only.
09 ¹⁶	156.450	156.450	
69	156.475	156.475	
71	156.575	156.575	
72	156.625	
78A	156.925	156.925	
79A	156.975	156.975	
80A	157.025	157.025	
67 ¹⁴	156.375	
Distress, Safety and Calling			
16	156.800	156.800	EPRIB
Intership Safety			
06	156.300	a. Intership, or b. For SAR: Ship and aircraft for the U.S. Coast Guard.
Environmental			
15 ¹³	156.750	Coast to ship only.
Maritime Control			
17 ^{9,10}	156.850	156.850	
Liaison, U.S. Coast Guard			
22A ¹¹	157.100	157.100	Ship, aircraft, and coast stations of the U.S. Coast Guard and at Lake Mead, Nev., ship and coast stations of the National Park Service, U.S. Department of the Interior.

- 1: 156.050 MHz and 156.175 MHz are available for port operations and commercial communications purposes when used only within the U.S. Coast Guard designated Vessel Traffic Services (VTS) area of New Orleans, on the lower Mississippi River from the various pass entrances in the Gulf of Mexico to Devil's Swamp Light at River Mile 242.4 above head of passes near Baton Rouge.
- 2: 156.250 MHz is available for port operations communications use only within the U.S. Coast Guard designated VTS radio protection areas of New Orleans and Houston described in Sec. 80.383. 156.250 MHz is available for intership port operations communications used only within the area of Los Angeles and Long Beach harbors, within a 25-nautical mile radius of Point Fermin, California.
- 3: 156.550 MHz, 156.600 MHz and 156.700 MHz are available in the U.S. Coast Guard designated port areas only for VTS communications and in the Great Lakes available primarily for communications relating to the movement of ships in sectors designated by the St. Lawrence Seaway Development Corporation or the U.S. Coast Guard. The use of these frequencies outside VTS and ship movement sector protected areas is permitted provided they cause no interference to VTS and ship movement communications in their respective designated sectors.

- 4: Use of 156.875 MHz is limited to communications with pilots regarding the movement and docking of ships. Normal output power must not exceed 1 watt.
- 5: 156.375 MHz and 156.650 MHz are available primarily for intership navigational communications. These frequencies are available between coast and ship on a secondary basis when used on or in the vicinity of locks or drawbridges. Normal output power must not exceed 1 watt. Maximum output power must not exceed 10 watts for coast stations or 25 watts for ship stations.
- 6: On the Great Lakes, in addition to bridge-to-bridge communications, 156.650 MHz is available for vessel control purposes in established vessel traffic systems. 156.650 MHz is not available for use in the Mississippi River from South Pass Lighted Whistle Buoy "2" and Southwest Pass entrance Midchannel Lighted Whistle Buoy to mile 242.4 above Head of Passes near Baton Rouge. Additionally it is not available for use in the Mississippi River-Gulf Outlet, the Mississippi River-Gulf Outlet Canal, and the Inner Harbor Navigational Canal, except to aid the transition from these areas.
- 7: Use of 156.375 MHz is available for navigational communications only in the Mississippi River from South Pass Lighted Whistle Buoy "2" and Southwest Pass entrance Midchannel Lighted Whistle Buoy to mile 242.4 above head of Passes near Baton Rouge, and in addition over the full length of the Mississippi River-Gulf Outlet Canal from entrance to its junction with the Inner Harbor Navigation Canal, and over the full length of the Inner Harbor Navigation Canal from its junction with the Mississippi River to its entry to Lake Pontchartrain at the New Seabrook vehicular bridge.
- 8: Within 120 km (75 miles) of the United States/Canada border, in the area of the Puget Sound and the Strait of Juan de Fuca and its approaches, 157.425 MHz is half of the duplex pair designated as Channel 88. In this area, Channel 88 is available to ship stations for communications with public coast stations only. More than 120 km (75 miles) from the United States/Canada border in the area of the Puget Sound and the Strait of Juan de Fuca, its approaches, the Great Lakes, and the St. Lawrence Seaway, 157.425 MHz is available for intership and commercial communications. Outside Puget Sound area and its approaches and the Great Lakes, 157.425 MHz is also available for communications between commercial fishing vessels and associated aircraft while engaged in commercial fishing activities.
- 9: When the frequency 156.850 MHz is authorized, it may be used additionally for search and rescue training exercises conducted by state or local governments.
- 10: The frequency 156.850 MHz is additionally available to coast stations on the Great Lakes for transmission of scheduled Coded Marine Weather Forecasts (MAFOR), Great Lakes Weather Broadcast (LAWEB) and unscheduled Notices to Mariners or Bulletins. F3C and J3C emissions are permitted. Coast Stations on the Great Lakes must cease weather broadcasts which cause interference to stations operating on 156.800 MHz until the interference problem is resolved.
- 11: The frequency 157.100 MHz is authorized for search and rescue training exercises by state or local government in conjunction with U.S. Coast Guard stations. Prior U.S. Coast Guard approval is required. Use must cease immediately on U.S. Coast Guard request.
- 12: The duplex pair for channel 20 (157.000/161.600 MHz) may be used for ship to coast station communications.
- 13: Available for assignment to coast stations, the use of which is in accord with an agreed program, for the broadcast of information to ship stations concerning the environmental conditions in which vessels operate, i.e., weather; sea conditions; time signals; notices to mariners; and hazards to navigation.
- 14: Available only in the Puget Sound and the Strait of Juan de Fuca.
- 15: The frequency 156.525 MHz is to be used exclusively for distress, safety and calling using digital selective calling techniques. No other uses are permitted.
- 16: The frequency 156.450 MHz is available for intership, ship and coast general purpose calling by noncommercial vessels, such as recreational boats and private coast stations.
- 17: The frequency 156.425 MHz is assigned by rule to private coast stations in Alaska for facsimile transmissions as well as voice communications.

19 WARRANTY

Marine Products Limited Warranty

PLEASE NOTE

The following “Limited Warranty” is for valid for products that have been purchased in the United States and Canada. For limited Warranty details outside the United States, contact the dealer in your country.

STANDARD HORIZON (a division of VERTEX STANDARD) warrants, to the original purchaser only, each new Marine Communications Product (“Product”) manufactured and/or supplied by STANDARD HORIZON against defects in materials and workmanship under normal use and service for a period of time from the date of purchase as follows:

Fixed Mount and Portable Transceivers

1 year - if purchased before 01/01/91

3 years - if purchased between 01/01/91 and 01/01/94

3 years Waterproof - if purchased after 01/01/94

Loud hailers

1 year - if purchased before 01/01/91

3 years - if purchased after 01/01/91

Associated Chargers

1 year - if purchased before 01/01/91

3 years - if purchased after 01/01/91

Associated Batteries - 18 months. Note: Batteries will be deemed defective only if storage capacity drops below 80% of rated capacity or if leakage develops.

Associated Accessories - 1 year. Includes: Microphones/Handsets, External Speakers, Antennas, Carrying Accessories, Power Supplies, and Signaling Boards.

To receive warranty service, the purchaser must deliver the Product, transportation and insurance prepaid, to STANDARD HORIZON (a division of VERTEX STANDARD), Attention Marine repairs 10900 Walker Street, Cypress, CA 90630. Include proof of purchase indicating model, serial number, and date of purchase. STANDARD HORIZON will return the Product to the purchaser freight prepaid. Products purchased prior to January 1, 1991 will bear the STANDARD HORIZON warranty terms in effect prior to that date.

In the event of a defect, malfunction or failure of the Product during the warranty period, STANDARD HORIZON's liability for any breach of contract or any breach of express or implied warranties in connection with the sale of Products shall be limited solely to repair or replacement, at its option, of the Product or part(s) therein which, upon examination by STANDARD HORIZON,

appear to be defective or not up to factory specifications. STANDARD HORIZON may, at its option, repair or replace parts or subassemblies with new or reconditioned parts and subassemblies. Parts thus repaired or replaced are warranted for the balance of the original applicable warranty.

STANDARD HORIZON will not warrant installation, maintenance or service of the Products. In all instances, STANDARD HORIZON's liability for damages shall not exceed the purchase price of the defective Product.

This warranty only extends to Products sold within the 50 States of the United States of America and the District of Columbia.

STANDARD HORIZON will pay all labor to repair the product and replacement parts charges incurred in providing the warranty service except where purchaser abuse or other qualifying exceptions exist. The purchaser must pay any transportation expenses incurred in returning the Product to STANDARD HORIZON for service.

This limited warranty does not extend to any Product which has been subjected to misuse, neglect, accident, incorrect wiring by anyone other than STANDARD HORIZON, improper installation, or subjected to use in violation of instructions furnished by STANDARD HORIZON, nor does this warranty extend to Products on which the serial number has been removed, defaced, or changed. STANDARD HORIZON cannot be responsible in any way for ancillary equipment not furnished by STANDARD HORIZON which is attached to or used in connection with STANDARD HORIZON's Products, or for the operation of the Product with any ancillary equipment, and all such equipment is expressly excluded from this warranty. STANDARD HORIZON disclaims liability for range, coverage, or operation of the Product and ancillary equipment as a whole under this warranty. STANDARD HORIZON reserves the right to make changes or improvements in Products, during subsequent production, without incurring the obligation to install such changes or improvements on previously manufactured Products.

The implied warranties which the law imposes on the sale of this Product are expressly LIMITED, in duration, to the time period specified above. STANDARD HORIZON shall not be liable under any circumstances for consequential damages resulting from the use and operation of this Product, or from the breach of this LIMITED WARRANTY, any implied warranties, or any contract with STANDARD HORIZON. IN CONNECTION WITH THE SALE OF ITS PRODUCTS, STANDARD HORIZON MAKES NO WARRANTIES, EXPRESS OR IMPLIED AS TO THE MERCHANTABILITY OR FITNESS FOR A PARTICULAR PURPOSE OR OTHERWISE, EXCEPT AS EXPRESSLY SET FORTH HEREIN.

Some states do not allow the exclusion or limitation of incidental or consequential damages, or limitation on how long an implied warranty lasts, so the above limitations or exclusions may not apply. This warranty gives specific legal rights, and there may be other rights which may vary from state to state.

ONLY PRODUCTS SOLD ON OR AFTER JANUARY 1, 1991 ARE COVERED UNDER THE TERMS OF THIS LIMITED WARRANTY.

ON-LINE WARRANTY REGISTRATION

THANK YOU for buying STANDARD HORIZON (a division of Vertex Standard) products! We are confident your new radio will serve your needs for many years!

Please visit **www.standardhorizon.com** to register your Marine VHF. It should be noted that visiting the Web site from time to time may be beneficial to you, as new products are released they will appear on the STANDARD HORIZON Web site. Also a statement regarding product support should be added to the manual.

Product Support Inquiries

If you have any questions or comments regarding the use of the radio, you can visit the STANDARD HORIZON Web site to send an E-Mail or contact the Product Support team at (714) 827-7600 ext 6300 M-F 7:00-5:00PST.

In addition to the warranty, STANDARD HORIZON includes a lifetime "flat rate" and "customer loyalty" programs to provide service after the warranty period has expired. If you wish to obtain the flat rate price for out-of-warranty repair, you must include the information on the Owner's Record with the unit when you return it to your Dealer or to STANDARD HORIZON.

Lifetime Flat Rate Service Program: For the original Owner only, for the lifetime of the unit, STANDARD HORIZON will repair the unit to original specifications.

Note: The flat rate amount is payable by the Owner only if STANDARD HORIZON or the STANDARD HORIZON Dealer determines that a repair is needed. After the repair, a 90-day warranty will be in effect from the date of return of the unit to the Owner.

This service program is not available for equipment which has failed as a result of neglect, accident, breakage, misuse, improper installation or modification, or water damage (depending on the product).

20 RESET PROCEDURES

20.1 MEMORY CLEAR

To clear the Scan memory and Preset memory:

1. Turn the radio off.
2. Press and hold in the three [Programmable] keys while turning the radio on.

20.2 MICROPROCESSOR RESETTING

To clear all memories and other settings to factory defaults (except the Channel Group, MMSI number, and DSC directory information):

1. Turn the radio off.
2. Press and hold in the [**16/9**], [**CALL(MENU)**], and [**CLR(WX)**] keys while turning the radio on.

21 SPECIFICATIONS

Performance specifications are nominal, unless otherwise indicated, and are subject to change without notice.

21.1 GENERAL

Channels	All USA, International and Canadian
Input Voltage	13.8 V DC \pm 20%
Current Drain	
Standby	0.55 A (GX2100), 0.45 A (GX2000)
Receiver (at Maximum AF Output)	0.9 A (GX2100), 0.8 A (GX2000)
Transmit	5.0 A (Hi), 1.0 A (Lo)
Distress Call Log	26
Individual Call Log	64
Individual Call Directory	80
Group Call Directory	32
Waypoint Directory	100
Dimensions (WxHxD)	7.1" x 3.1" x 6.3" (180 x 80 x 160 mm)
Flush-Mount Dimensions (WxHxD)	6.3" x 2.6" x 5.9" (161 x 65 x 150 mm)
Weight (GX2000)	3.1 lbs (1.40 kg)
Weight (GX2100)	3.2 lbs (1.45 kg)

21.2 TRANSMITTER

Frequency Range	156.025 MHz to 157.425 MHz
RF Output Power	25 W (Hi), 1 W (Lo)
Conducted Spurious Emissions	Less than -80 dBc (Hi), -66 dBc (Lo)
Audio Response	within +1/-3dB of a 6 dB/Octave pre-emphasis characteristic at 300 to 3000 Hz
Audio Distortion	Less than 5 %
Modulation	16K0G3E (for Voice), 16K0G2B (for DSC)
Frequency Stability	\pm 0.0003 % (-20 °C to +60 °C)
FM Hum and Noise	50 dB

21.3 RECEIVER (for Voice and DSC)

Frequency Range	156.050 MHz to 163.275 MHz
Sensitivity	
20 dB Quieting	0.35 μ V
12 dB SINAD	0.30 μ V
Squelch Sensitivity (Threshold)	0.13 μ V
Modulation Acceptance Bandwidth	\pm 7.5 kHz
Selectivity (Typical)	
Spurious and Image Rejection	80 dB for Voice (75 dB for DSC)
Intermodulation and Rejection	80 dB for Voice (75 dB for DSC)
Audio Output	4.5 W (at 4 ohms external speaker output)
Audio Response	within +1/-3dB of a 6 dB/Octave de-emphasis characteristic at 300 to 3000 Hz
Frequency Stability	\pm 0.0003 % (-20 °C to +60 °C)
Channel Spacing	25 kHz
DSC Format	ITU-R M.493-12
Antenuator (Local)	Approx. 10 dB

21.4 RECEIVER (for AIS)

Frequency	161.975 MHz (CH A), 162.025 MHz (CH B)
Sensitivity	0.5 μ V (at 12 dB SINAD)
Selectivity(Typical)	
Spurious and Image Rejection	70 dB
Intermodulation and Rejection	70 dB

21.5 NMEA Input/Output

NMEA-0183 (4800bps for Position Data) ...	Input:GLL, GGA, GNS and RMC Output:DSC, DSE
NMEA-0183 HS (38400bps for AIS Data)	Input:VDM (GX2000) Output: VDM (GX2100)



**Marine Division of VERTEX STANDARD
US Headquarters**

10900 Walker Street, Cypress, CA 90630, U.S.A.

www.standardhorizon.com



E M O 4 4 N 1 0 0

Copyright 2009
VERTEX STANDARD CO., LTD.
All rights reserved.

No portion of this manual
may be reproduced
without the permission of
VERTEX STANDARD CO., LTD.