

Horizon *Strike 200/220s*

Fishfinder

Owner's Manual



MARINE PRODUCTS LIMITED WARRANTY

Standard Communications Corp. (SCC) warrants to the original consumer purchaser (the Purchaser) only that each new Marine Product will be free from defects in materials and workmanship under conditions of normal use and service for a period of one (1) year from the date of delivery to the Purchaser. SCC's liability under this warranty shall be limited to repair or replacement of the defective product, at SCC's option, and under no circumstances shall SCC be liable for consequential, incidental, or other damages arising out of or in any way connected with a failure of the product to perform as set forth herein.





THIS LIMITED WARRANTY EXTENDS ONLY TO THE PURCHASER AND IS IN LIEU OF ALL OTHER EXPRESS OR IMPLIED WARRANTIES, INCLUDING THOSE OF MERCHANTABILITY AND FITNESS FOR A PARTICULAR PURPOSE.

In the event of a defect, malfunction, or failure of the product to conform to specifications during the one-year warranty period, SCC will repair or replace, at its option and without charge to the Purchaser, the product which upon examination by SCC shall appear to be defective or not up to factory specifications. SCC will pay all labor charges incurred in providing such warranty service. To obtain warranty service, the defective product must be returned to SCC together with proof of the date of purchase. The Purchaser must pay any transportation expenses in returning the product to SCC. SCC will examine the product and respond to the Purchaser in approximately four (4) weeks from date of receipt of the product claimed to be defective.

This limited warranty does not extend to any product which has been subjected to misuse, neglect, accident, improper installation, or subject to use in violation of the maintenance or operating instructions, if any, furnished by SCC; nor does this warranty extend to products on which the serial number has been removed, defaced, or changed. SCC reserves the right to make changes or improvements to its products during subsequent production without incurring the obligation to install such changes or improvements on previously manufactured or sold products.

Some states do not allow limitations on the duration of the warranty or exclusions or limitations of incidental or consequential damages so these limitations or exclusions may not apply to you. This warranty gives you specified legal rights which vary from state to state.

Contents

Introduction	4
Specifications	4
Installation	5
Location	5
Installation – The Transducer	6
• Transom Mount Transducer	6
Location	6
Mounting	6
• Other Types of Transducers	7
Wiring connection	7
Electrical protection	7
Operation	8
Introduction	8
Primary functions and quick operation introduction	8
Menu selection system	8
Display and Operating Modes	9
Echo mode 	9
Autofish mode 	9
Analogue-scope function 	10
Navigate Mode 	10
Changing the mode of operation	11
Range function	11
Setting the display range	11
Gain function	12
Setting the gain	12
Display scroll speed	13
Setting the scroll speed	13
Alarms	14
Anchor Drag Alarm	14
Setting the alarms	14
Setup Menu	15
Changing the setup functions	15
Setup Menu – Speed & Temperature (Strike 220s only)	16
Changing the speed & temperature setup	16
Speed Comparison Method	16
Log Calibration Method	16
Troubleshooting	17
Accessory Part Numbers	18

Introduction

Thank you for purchasing a Horizon 200 SERIES fishfinder. The 200 SERIES is a powerful, yet easy to use sonar fish and bottom depth detector. Please read this manual carefully before installing and using your fishfinder. This manual deals with both the *Strike 200* and *220s*. The more you know and understand about the capabilities of the unit, the better it will perform for you.

Specifications for 200 SERIES

- **Dimensions**
5.2" (132 mm) W (max) x 5.25" (133 mm) H x 1.8" (46 mm) D
- **Depth Capability**
600 feet, 180 metres
- **Transducer Type**
Aquatic transom-mount single beam. Thru hull transducer options are also available.
- **Operating Frequency**
200 kHz
- **Receiver Sensitivity**
30 micro volts RMS
- **Power Output**
440 watts RMS (3500 watts peak-to-peak) maintained within 10% down to 10.5 volts.
- **Display Size**
4¼" (100mm) Diagonal.
3¼" x 3" (82 mm x 76 mm)
- **Display Type**
STN temperature compensated
- **Display Matrix**
100 x 64 pixels
- **Input Voltage**
10 to 18 volts DC @ 150 mA max. (lights on)
- **Backlighting**
Even illumination. Seven levels plus off.
- **Operation Temperature**
32°F to 104°F ambient (0°C to 40°C)

Additional *Strike 220s* Specifications

- **Boat Speed**
0.0–50.0 kts, mph, kph user selectable
- **Water Temperature**
32.0–99.0°F (0.0–40.0°C) user selectable
- **Log**
Records up to 9999.9 nm, km, stored in memory, resettable.

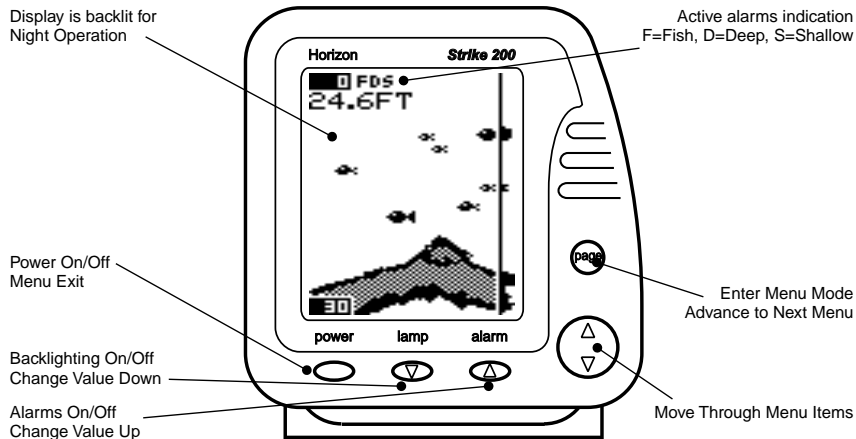

Installation

Location

The *Strike 200* and *220s* are water resistant and may be mounted and operated in many positions thanks to its compact and robust bracket, associated with a swivel support.

Note

It may be advisable to install the transducer and wiring before finalising the location of the display head and bracket.

When installing the display head, select a position

where it will be:

- at least 12" (300 mm) away from the compass.
- at least 12" (300 mm) away from any radio transmitter, such as the VHF.
- easy to read by the helmsman and crew while under way.
- protected from physical damage during rough sea passages.
- have easy access to the 12 volt power source.
- convenient to route the transducer cables.

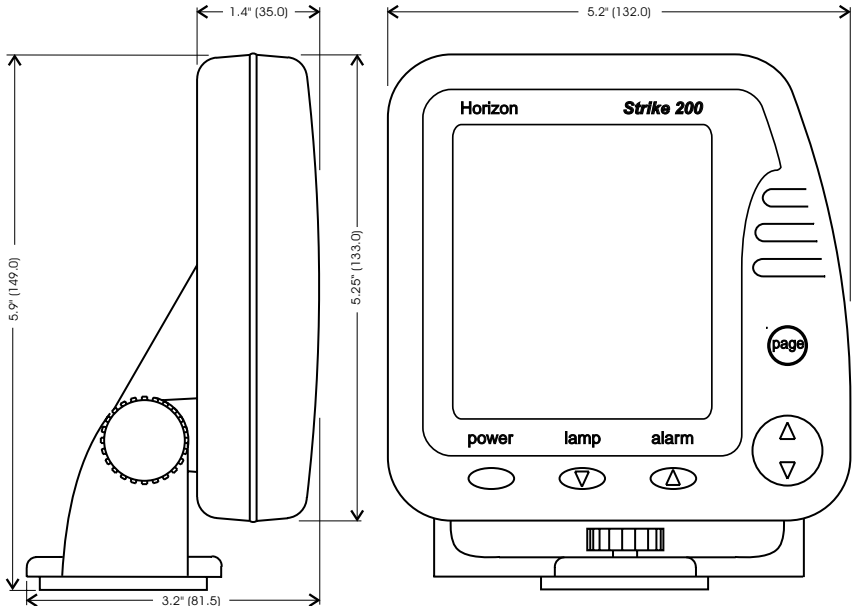

Installation – The Transducer

Read this section carefully before attempting the transducer installation. **Remember, the transducer location is the most critical part of the installation.** If this is not done properly, the transducer can't perform at its designed potential. Therefore the performance of the fishfinder, especially at higher speeds, will not be satisfactory.

• Transom Mount Transducer

Location

The transducer can be installed on any outboard or sterndrive powered boat. The transom mount transducer has a safety "kick up" mounting bracket to help minimise damage to the transducer should it impact the bottom or floating debris in the water.

Select a position for the transducer that will:

- allow the transducer a smooth flow of water over its surface at all times.
- ensure a mount as deep in the water as possible.
- be clear of any interference from the trailer when launching or retrieving the boat.
- be away from planing strakes or other projections from the hull that may cause aerated water to flow over the face of the transducer.
- be away from the propeller
- be at least 150 mm (6") away from the keel of the boat.

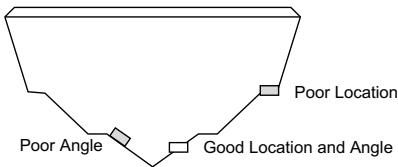

Mounting

Once the best location of the transducer is determined, hold the transducer and bracket against the transom. The bottom surface of the transducer needs to sit parallel to the surface of the water for the best signal return. The lower face of the transducer should extend down below the bottom of the hull so that it will be below the surface of the water at high speeds. (See fig. 2.1)

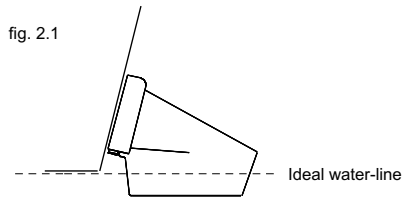

Mark the transom through the bracket slots to correctly place the two outer screws. Now drill the two holes in the centre of the slots. This will allow you to adjust the transducer position later on if required. Use two of the three stainless screws supplied to attach the bracket to the transom. Ensure the lower face of the transducer is parallel with the ground (see fig. 3.1 and 3.2). Tighten the two screws.

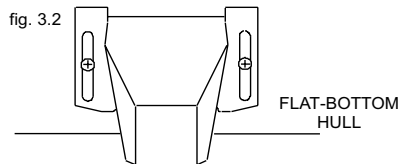
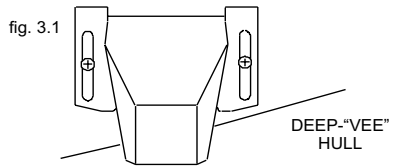

Wiring connection

Finally, drill a hole and insert the third screw in the middle of the bracket. It is advisable to fill holes with a sealing compound before inserting screws (see fig. 3.3).

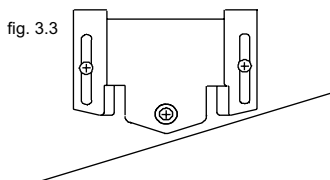

• Other Types of Transducers

It is possible to use your Horizon Fish Finder with all the Horizon Transducers Range (including thru-hull mounting). For this purpose you need to purchase the Y adaptors for the *Strike 200* and *220s*, which will allow you to separate the power cable from the transducer's cable.

Electrical protection

- Your fishfinder has an internal electrical protection system for over voltage and short circuit situations. It is not necessary to use a fuse or a circuit breaker.

If possible, route the transducer cable away from other wiring on the boat. Electrical noise from engine wiring, bilge pumps, and other equipment can affect the display.

- Both the power and depth transducer cables lead into one four pin connector on the *Strike 200* or the eight pin connector on the *Strike 220s*. This plugs into a single socket in the rear of the instrument. Connect the red wire of the two-core power cable to the positive supply and the black wire to the electrical ground. The shortest and most direct connection to the boat's battery will help to eliminate any problems due to voltage drop or electrical interference.

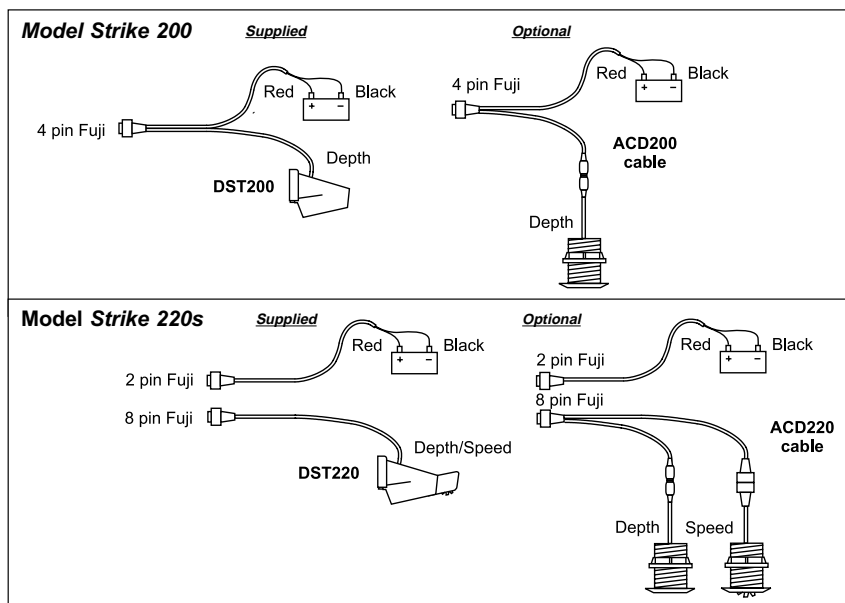

Operation

Introduction

The *Strike 200* and *220s* use sonar technology to display lake or seabed contours and to detect fish. The system consists of an LCD display unit and a depth transducer positioned in the water. The model *Strike 220s* is also supplied with integrated boat speed and water temperature sensors.

Primary functions and quick operation introduction

power	<p>Turns the power ON and OFF</p> <ul style="list-style-type: none">• Press for one second to turn the power ON• Press and hold for three seconds to turn the power OFF <p>Selects digital information to be displayed in the top left corner of the Fish Finder screen. Returns the unit to operating mode from any menu.</p>
lamp ▼	<p>Turns the backlighting ON or OFF</p> <ul style="list-style-type: none">• Press once to turn the backlights ON• Press again to turn the backlights OFF <p>Decreases setting values in menus.</p>
alarm ▲	<p>Turns the alarms ON or OFF</p> <ul style="list-style-type: none">• Press once to turn the alarm ON• Press again to turn the alarm OFF <p>Increases setting values in menus.</p>
page	<p>Enters menu mode Advances to the next menu</p>
▲ = ▼	<p>Moves through the list of items in each menu</p>

The LCD screen is menu driven for ease of use. The automatic detection can locate and display the position of fish with three different size fish symbols. This feature can be disabled so that the LCD will display only the raw electronic signals. Experienced users can use this mode to extract even more information about the water and seabed conditions.

Note

Momentarily pressing the power key removes or displays depth, speed and temperature data (depth only in the Strike 200) from the upper left corner of the display. The format chosen is retained in memory when the power is switched off.

Menu selection system

Your fishfinder has many features that may be selected for adjustment. Each of these features have a menu screen. You may access all the menu screens by repeatedly pressing the **page** key.

Menus such as the manual gain control, shallow and deep water alarms have additional numerical control windows. The number in this window is changed by using the ▼ and ▲ keys. Any changes made are recorded in memory as soon as you exit the menu screen. **All changes are stored in memory when the power is switched off.**

Note

To exit or clear any menu from the screen, press the power key.

Display and Operating Modes

The Horizon 200 SERIES Fishfinders have five modes of operation. These are Echo, Echo + Analogue Scope, AutoFish, AutoFish + Analogue Scope and Navigate.

Echo mode

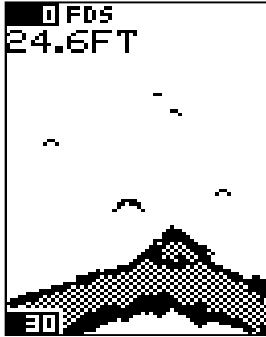

The Echo mode displays the return signals as they are received from the transducer. Fish appear as arches and not as fish symbols. The length of the arch will indicate the relative size of the return echo and size of the fish.

The Echo mode enables the unit to display echoes caused by surface turbulence, thermal layers, plankton or transducer noise when the boat is moving. This mode is very useful for the experienced user.

The digital display in this sample window is indicating the depth of the bottom. The display units are also user selectable

Autofish mode

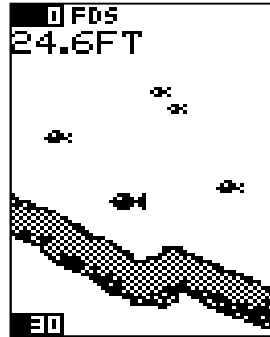

The Autofish mode automatically analyses the return echoes and displays echoes with fish icons (the bigger the echoes, the bigger the icon!).

The return echo is caused when the sonar beam strikes the air stored in the fishes swim bladder. Certain types of fish have larger swim bladders than normal so the size of the icon is not always a reliable way to indicate the relative size of the fish.

In the Autofish mode, unnecessary surface noise is reduced from the top of the screen. This mode is recommended when your boat is moving along at higher speeds.

Analogue-scope function

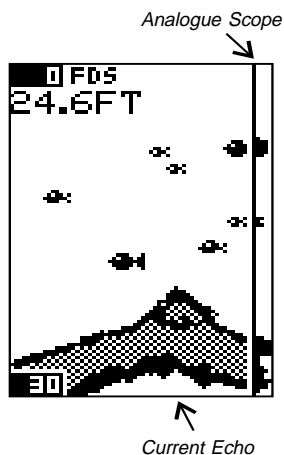

The Analogue-scope function is available in either the Echo or Autofish modes. This feature displays an intensity graph of the current echoes down the right hand side of the screen.

The information can be used to help determine the type of bottom structure and the size of fish. The strength of the echo is proportional to size or number of pixels visible in the analogue section of the screen. This feature will help to determine the strength of the return echo from the bottom and therefore how hard or soft the bottom may be.

Navigate Mode

In this mode the depth, speed and temperature are displayed in large easily readable digits. This is useful when navigating to your favourite fishing location.

To increase precision, the values are displayed in 0.1 increments.

Model *Strike 200*

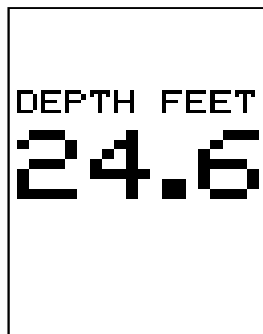

Displays depth only

Model *Strike 220s*

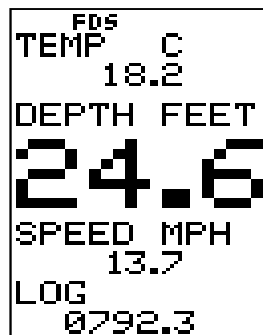

You may display water temperature in degrees °F or °C. The depth of the bottom in feet, metres or fathoms. The speed of the boat in mph, knots or kph.

The log will display the total distance in the speed unit you have selected. The log total is automatically stored in memory when the power is switched off or removed but this value can be reset to zero (see SETUP menu).

When either or all of the Fish (F), Shallow (S) or Deep (D) alarms are active they are displayed at the top left corner of the screen.



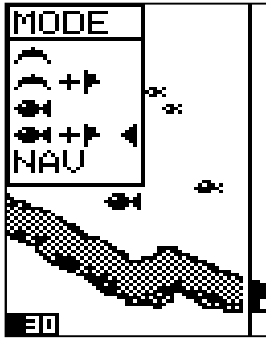

Range function

Changing the mode of operation



- Press the **page** key to activate the **mode** menu
- Press either the **▲** key or the **▼** key to move the pointer to the desired mode of operation
- Press the **power** key to accept the choice and return to normal display mode

The symbols in the display box are as follows

-  Echo mode
-  Echo mode + analogue scope
-  Autofish mode
-  Autofish + analogue scope mode
- NAU** Navigate data mode

The range function allows you to control the depth range that is displayed on the LCD. There are three different range modes; **Top**, **Bottom**, and **All**.

If **Top** is selected then a lower depth limit value must also be selected. This mode locks the display to show only echoes from the surface of the water down to the lower depth limit you have selected. This means that the sea bed may not be shown if the water is deeper than the selected lower depth limit.

If **Bottom** is selected then an upper depth limit must also be entered. This mode locks the display to show only echoes between the sea bed and the upper depth limit you have selected. The top of the water may not be shown if the water is deeper than the upper depth limit. This feature is like a ZOOM function, as it allows you to see the bottom contour and fish echoes above the bottom in greater detail.

If **All** is selected then the unit will automatically adjust the display range to show both the top of the water and the sea bed no matter what the depth of the water is.

Setting the display range



Depth Range Limit

- Press the **page** key until the **range** menu is displayed.
- Press either the **▲** key or the **▼** key to move the pointer to the desired mode of operation

- If the desired mode is **Top** or **Bottom** then use the **▼** or the **▲** key to adjust the limit value to the desired level
- Press the **power** key to accept the choice and return to normal display

Gain function

The gain is a measure of ability to receive weak signals. The higher the gain setting, the better the unit is able to pick up weak return signals. Deep water operation requires the gain to be set to a higher value due to loss of signal in the water.

There are two gain modes that can be selected, **Manual** and **Auto**.

If **Manual** is selected then a gain setting from 0 to 15 must also be entered. This will be the value of gain that is always used when displaying information on the screen. A low gain number may be suitable in shallow water but will need to be increased for deep water operation

If **Auto** is selected then the gain will automatically vary as the water depth changes. This feature is particularly useful if you are fishing areas where the depth changes suddenly. In Auto mode, you can set the auto-gain value to provide a consistent image of the bottom, regardless of the bottom type. A low auto-gain setting will cause a thin bottom image to be displayed. A high auto-gain setting will result in a thick bottom image. This adjustment is particularly useful with a weak return signal from a muddy or silty bottom. Normally, in these conditions the auto-gain will increase the gain to a level that may make the display appear too cluttered, making it difficult to distinguish fish. In this situation the auto-gain can be reduced to display a weak bottom image but with improved fish images.

Setting the gain

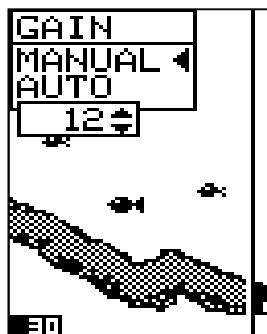

- Press the **page** key until the **gain** menu is displayed
- Press either the **▲** key or the **▼** key to move the pointer to the desired mode of operation
- If the desired mode is **Manual** then use the **▼** or the **▲** key to adjust the value to the desired level
- Press the **power** key to accept the choice and return to normal display mode
- If the desired mode is **Auto** then use the **▼** or the **▲** key to adjust the value to the desired level. In **Auto** mode the gain will be controlled to show the same bottom detail irregardless of depth

Display scroll speed

The scroll speed is the speed that the picture moves across the screen. It is adjustable in three distinct steps, **slow**, **medium** and **fast**. In general the faster scroll speed will work better with higher boat speeds. The slower scroll speeds are more suitable for slow speed trolling and slower vessels. The most suitable scroll speed is determined by experimentation

Setting the scroll speed

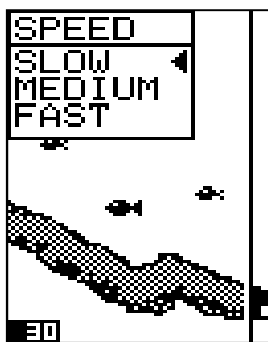

- Press the **page** key until the **speed** menu is displayed
- Press either the **▲** key or the **▼** key to move the pointer to the desired scroll speed
- Press the **power** key to accept the choice and return to normal display mode

Alarms

There are three different types of alarms, **Fish**, **Shallow**, and **Deep**. All the alarms activate the internal buzzer if their alarm condition is met. The buzzer will provide three different alarm signals. A short alarm signal for a mid water echo, such as a fish, a long continuous signal for a shallow water alarm and a series of short signals for a deep alarm. Each alarm can be individually enabled or disabled. All enabled alarms can be simultaneously disabled with a single key press.

The alarm indicator bar on the top left of the display shows which alarms have been selected. They are fish 'F', shallow 'S', and deep 'D'.

Fish Alarm Alerts you with a single short signal when an object that could be a fish is detected. The alarm for a small fish is shorter than the alarm for a bigger fish.

Shallow Alarm Alerts you when the water depth is shallower than the shallow alarm setting, i.e., the water becomes too shallow.

Deep Alarm Alerts you when the water depth is deeper than the deep alarm setting, i.e., the water becomes to deep.

Alarms on the *Strike 220s*

When either or all of the Fish, Shallow or Deep alarms are active they are displayed on the screen. When an alarm is triggered there is a beep and the corresponding alarm's figure flashes on and off.

Anchor Drag Alarm

The Shallow and Deep Alarms can be set just above and below your anchored depth. An alarm will sound if your anchor drags and you drift into deeper or shallower water.

Be sure to disable the fish alarms in this mode to prevent false anchor drag alarms due to fish.

Setting the alarms

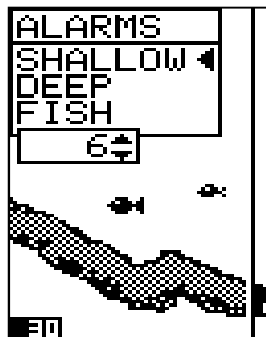

- Press the **page** key until the **alarms** menu is displayed
- Press either the **▲** key or the **▼** key to move the pointer to the required alarm
- Use the **▼** or the **▲** key to adjust the alarm setting to the desired depth level. OFF is shown if shallow alarm value is 0 or deep alarm value of 600 feet is selected
- Press the **power** key to accept the choice and return to normal display mode

Setup Menu

The setup menu enables you to customize the 'look and feel' of the instrument. There are six parameters that can be adjusted. Lamp intensity, units of measure, keel offset, training mode, LCD contrast and white line operation.

Lamp Intensity The intensity of the night vision lights can be adjusted from 1 to 7 and OFF.

Units Of Measure Depth can be displayed in either feet (FT), meters (M), or fathoms (FA).

Keel Offset The depth of water is normally measured from the face of the transducer to the bottom. You can enter an offset which will be added or subtracted from the calculated depth before it is displayed on the LCD. Entering a positive offset can be used to display the depth of water below the keel. Entering a **negative** offset can be used to display the depth of the water below the keel. Entering a **positive** offset can be used to show depth from the water surface to the bottom. When entering a zero as an offset, the fishfinder will display depth of water below the transducer.

Simulation Mode This setting will enable a training mode which allows you to learn to use all the different features in this instrument.

LCD Contrast You can adjust contrast level from 0 to 7 to match your preference. Special circuitry will also automatically adjust the contrast for changes due to temperature.

White Line This feature displays the bottom signal as a thin line, with a variable width band beneath it. This indicates the bottom hardness and also allows you to separate targets near the bottom of the sea bed. This function will also remove most surface echo signals from the top of the screen.

Changing the setup functions

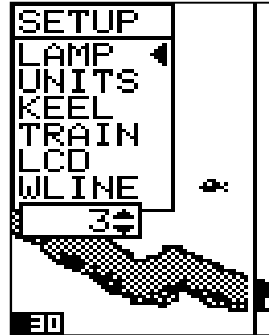

- Press the **page** key until the **setup** menu is displayed
- Press either the **▲** key or the **▼** key to move the pointer to the required setup item
- Use the **▼** or the **▲** key to adjust the setting to the desired value
- Press the **power** key to accept the choice and return to normal display mode

Setup Menu – Speed & Temperature (*Strike 220s* only)

Changing the speed & temperature setup

The *Strike 220s* fishfinder is able to display boat speed, water temperature, and water depth. This menu enables you to customise the display of speed and temperature and to change the calibration setting of these features.

Temperature units Temperature can be displayed in either °F or °C.

Temperature calibration If the displayed temperature is known to be wrong then it can be adjusted using this function. The calibration value is saved in memory automatically.

Speed units of measure Speed can be displayed in either knots (KTS) miles per hour (MPH) or kilometres per hour (KPH).

Speed calibration If the displayed speed is known to be wrong then it can be adjusted using this function. The calibration value is saved in memory automatically.

Reset log The distance log can be reset by changing this option from 'NO' to 'YES'. If the selection is YES, the log will be reset when you exit this menu.

- Press the **page** key until the **setup 2** menu is displayed
- Press either the **▲** key or the **▼** key to move the pointer to the required setup item
- Use the **∨** or the **∧** key to adjust the setting to the desired value
- Press the **power** key to accept the choice and return to normal display mode

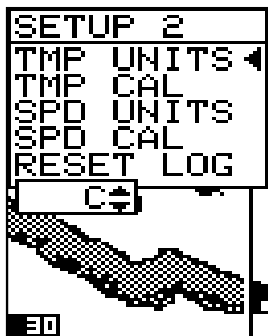

Speed Comparison Method

Use the following sequence to adjust the speed displayed to match that of another craft or the speed displayed on a GPS receiver. Enter the Speed calibration mode as described on page 16 of the manual, **SETUP 2 Menu / SPD CAL**.

To increase reading, press the **▲** key.

To decrease reading, press the **▼** key.

Adjust to desired speed, **press** the power key to store in memory and exit.

Log Calibration Method

Go to the **SETUP 2 Menu / RESET LOG** and reset the log to zero. Travel a known distance between two points. If there is any tidal current, you should travel the course in both directions and twice the known distance. Avoid situations where the current is flowing at right angles to the course. If this cannot be avoided, make sure that the boat speed is at least ten times the speed of the current.

You may calculate a correction factor as follows:

$$\text{Correction Factor} = \frac{\text{Known distance}}{\text{Distance from log}}$$

For example, if you have travelled over a known distance of 1 mile but your log reading is 0.80, the correction factor is 1.25.

$$\text{Correction Factor} = \frac{1.00}{0.80} = 1.25$$

Therefore, your correct boat speed will be the indicated speed multiplied by 1.25. For example, a current boat speed of 4.00 KTS should be increased to 5.0 KTS (4.0 x 1.25). Go to the **SETUP 2 Menu / SPD CAL** and adjust to the correct speed.

Troubleshooting

The Fishfinder won't turn on:

1. Check the power cable socket at the back of the Fishfinder.
2. Make certain the power cable's red wire connects to the positive battery terminal and the black wire to negative or ground.
3. Measure the voltage at the unit's power terminals. It should be at least 10 volts. If it isn't:
 - the battery terminals or wiring on the terminals are corroded
 - the battery needs charging.
 - the wiring to the unit is defective
4. Check any fuses you may have placed in the line.

The Fishfinder freezes, locks up, or operates erratically:

1. Electrical noise from the boat's engine or an accessory may be interfering with the sonar unit.
To stop this, try:
 - re-routing the power and transducer cables away from the other electrical wiring on the boat
 - routing the unit's power cable directly to the battery instead of through a fuse block or ignition switch
2. Inspect the transducer cable for damage or pinched wires.
3. Check the transducer and power connector. Make certain it is securely plugged into the unit.

Weak bottom echo, digital readings erratic, or no fish signals:

1. Make certain the transducer is pointing straight down.
2. Electrical noise from the boat's motor can interfere with the Fishfinder. This causes the Fishfinder to automatically decrease the gain level unless the gain control has been set manually. The Fishfinder thus eliminates weaker signals such as fish or even the sea bed from the display.
3. Manual gain may be set too low, if you have the instrument set in manual mode.
4. The water may be deeper than the Fishfinder's ability to find the bottom. If it cannot find the bottom return signal while it is in the automatic mode, the display will flash continuously. It may change the range to a realistic one, and increase the sensitivity. As you move into shallower water, a bottom signal should appear.
5. Check the battery voltage. If it is too low, the unit's transmitter power is also low, reducing its ability to find the bottom or targets.

Bottom echo disappears or erratic digital reading while your boat is moving:

1. The transducer may be in turbulent water. Air bubbles in the water disrupt the Fishfinder signals, interfering with its ability to find the bottom or other targets. This often happens when you reverse the boat. The transducer must be mounted in a smooth flow of water in order for the Fishfinder to work at all boat speeds.
2. Again, electrical noise from the boat's motor can interfere with the Fishfinder.

Accessory Part Numbers

Accessory	SCC Part #
DST220 Paddle Wheel Kit	602007011A
Mounting Bracket	160006020A
Swivel Bracket	106667020A
MB Knobs	154003016A
Washers	581004030A
Mounting Bracket Kit <i>(contains all of the above brackets, knobs and washers)</i>	602008011A



Standard Communications Corp.
P.O. Box 92151
Los Angeles, CA 90009-2151
Telephone 310/532-5300

© STANDARD COMMUNICATIONS CORP.
ALL RIGHTS RESERVED
PRINTED IN NEW ZEALAND
MARCH 1998

MN000045
1950702B



Standard Communications

Insert

Addendum to Horizon Strike 200/220s Owner's Manual

The following explains how to use the features added in software version 4.

New Key Functions

A key PRESS is a normal short key activation, a key HOLD is a continuous key activation for 1 second. When a key is pressed there is a short beep. After it has been held for 1 second there is a long beep. Hold the Lamp or Alarm key when changing values for faster increase or decrease of value. (eg alarm depths)

Gain Menu Removed

There is no longer a separate gain menu. This has been replaced by the new gain feature.

New Gain Feature

The cursor key alters gain except when a menu is displayed. The gain setting is displayed at the top of the screen. To set gain use the Cursor key which increases or decreases the manual value through levels M1 to M8 then cycles to auto gain. (Auto is displayed A1 to A7)

New Page Back Feature

Hold the Page key to jump to the page you last altered. When a page is displayed holding the Page key steps backwards through the menus.

New Depth Range Quick Set

Depth Range can now be quickly set to display the bottom at the best available range setting. Hold the Cursor key (either way) for 1 second or longer.

New Jump to NAV Screen Feature

By holding the Power key while in the Fish mode you jump to the NAV screen retaining the Autofish or Echo modes. (Note that the power off sequence is started then aborted.) Press Power key to return to fish mode.

New Individual Alarm Off Feature

While setting either the Shallow or Deep alarm depths, pressing both the Alarm and Lamp keys simultaneously will switch the alarm off without changing the depth.

How to Calibrate Speed: Log Method (Strike 220s only)

Go to the SETUP 2 Menu / RESET LOG and reset the log to zero. Travel a known distance of at least a nautical mile between two points in a straight line. Best results are achieved in calm conditions where there is minimal current (best at high or low tide).

Divide the known distance by the distance indicated on the log to get the correction factor.

Multiply your displayed speed by the correction factor to get actual speed, and go to SETUP 2 Menu / SPD CAL to adjust to that speed. (Tip: Use simulate mode to do this while stationary).

For example, if you have travelled a known distance of 2.0 miles but your log is reading 1.6, then the correction factor is 1.25. (ie Correction Factor = $2.0 \div 1.6 = 1.25$)

(Note: If there is a current, travel the distance in both directions to negate the effects of the current. It is essential to travel as near to parallel to the current as you can. If you cannot do this then the error caused by the cross current is reduced when the boatspeed is greater than ten times the current.)

Note: If you have another calibrated device, or can match the speed of another boat then you may recalibrate speed under SETUP 2 / SPD CAL. Increase or decrease as required.

Names of Keys.

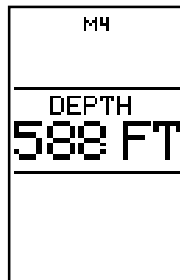
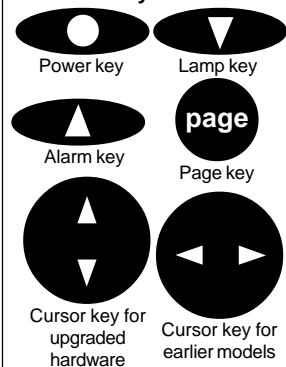

Strike 200 NAV screen shows "M4"
(Manual Gain at level 4)

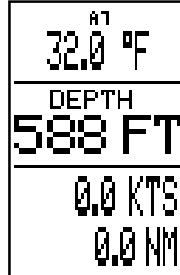

Strike 220s NAV screen shows
"A7" (Auto Gain at level 7)